

# USB-to-Serial Conversion Unit Instruction Manual (Detailed)

## USB001Z

### Contents

Safety precautions .....	1 -
1. Introduction .....	4 -
2. Exterior features .....	5 -
3. Installing the device driver .....	6 -
3.1. Windows XP .....	7 -
3.2. Windows Vista .....	11 -
3.3. Windows 7 .....	15 -
3.4. Windows 8 .....	21 -
3.5. Windows 10 .....	28 -
4. Checking the COM port number .....	33 -
4.1. Windows XP .....	33 -
4.2. Windows Vista, 7 .....	35 -
4.3. Windows 8 .....	37 -
4.4. Windows 10 .....	40 -
5. Uninstalling the device driver .....	41 -
5.1. Windows XP .....	41 -
5.2. Windows Vista, 7 .....	43 -
5.3. Windows 8 .....	45 -
5.4. Windows 10 .....	47 -
6. Connecting and starting the USB001Z unit .....	49 -
7. Outline drawing .....	51 -
8. Specifications .....	52 -
9. Warranty .....	53 -



#### NOTICE

1. Make sure that this instruction manual is delivered to the end user of USB-to-serial conversion unit.
2. Read this manual before installing or operating the USB-to-serial conversion unit. Keep it in a safe place for reference.
3. All information contained in this manual is subject to change without notice. Please confirm the latest information from your distributor.

## Safety precautions

The items described in these instructions and on the inverter itself are very important so that you can use the inverter safely, prevent injury to yourself and other people around you as well as to prevent damage to property in the area. Thoroughly familiarize yourself with the symbols and indications shown below and then continue to read the manual. Make sure that you observe all warnings given.



### Explanation of markings

Marking	Meaning of marking
 <b>WARNING</b>	Indicates that errors in operation may lead to death or serious injury.
 <b>CAUTION</b>	Indicates that errors in operation may lead to injury (*1)to people or that these errors may cause damage to physical property.(*2)

(\*1) Such things as injury, burns or shock that will not require hospitalization or long periods of outpatient treatment.

(\*2) Physical property damage refers to wide-ranging damage to assets and materials.

### Meanings of symbols

Marking	Meaning of marking
	Indicates prohibition (Don't do it). The prohibition detail will be described in or near the symbol in either text or picture form.
	Indicates something mandatory (must be done). The mandatory detail will be described in or near the symbol in either text or picture form.
	Indicates caution. The caution detail will be described in or near the symbol in either text or picture form.





#### ■ Limit in purpose





### Safety precaution



- ▼ Never use the USB-to-serial conversion unit with any device other than a TOSVERT series inverter, or it will cause an accident.

■ **General Operations**



 <b>WARNING</b>	
 Disassembly prohibited	<ul style="list-style-type: none"> <li>• Never disassemble, modify or repair. This can result in electric shock, fire and injury. For repairs, call your sales agency.</li> </ul>
 Prohibited	<ul style="list-style-type: none"> <li>• Do not place or insert any kind of object into the unit (electrical wire cuttings, rods, wires). This can result in electric shock or fire.</li> <li>• Do not allow water or any other fluid to come in contact with the unit. This can result in electric shock or fire.</li> </ul>
 Mandatory	<ul style="list-style-type: none"> <li>• If the unit begins to emit smoke or an unusual odor, or unusual sounds, immediately turn power off. If the equipment is continued to operate in such a state, the result will be fire. Call your local sales agency for repairs.</li> </ul>



■ **Transportation & installation**

 <b>WARNING</b>	
 Prohibited	<ul style="list-style-type: none"> <li>• Don't place any inflammable objects nearby. If a flame is emitted due to malfunction, it will result in a fire.</li> <li>• Don't install in any location where the unit could come into contact with water or other fluids. This can result in electric shock or fire.</li> </ul>
 Mandatory	<ul style="list-style-type: none"> <li>• Must be used in the environmental conditions prescribed in the instruction manual. Use under any other conditions will result in malfunction.</li> <li>• Provide your inverter or other equipment with safety devices to prevent a serious accident from resulting even if the unit malfunctions or fails to operate. Usage without a safety device can result in an accident.</li> </ul>

 <b>CAUTION</b>	
 Prohibited	<ul style="list-style-type: none"> <li>• Do not connect a LAN cable or modular cable for telephones to the conversion unit. Doing so will cause a failure or accident.</li> <li>• Do not connect more than one conversion unit to one host device (computer). Doing so will cause a failure or accident.</li> </ul>
 Mandatory	<ul style="list-style-type: none"> <li>• Use the Toshiba-specified cable for connecting this optional unit. (Refer to page 5.) The use of any other option will result in an accident.</li> <li>• The following steps must be performed before wiring to an inverter.                             <ol style="list-style-type: none"> <li>(1) Turn off all input power to the inverter.</li> <li>(2) Wait at least 15 minutes and check to make sure that the charge lamp of inverter is no longer lit.</li> <li>(3) Use a tester that can measure DC voltage 800VDC or more, and check to make sure that the voltage to the DC main circuits (between PA/+ and PC/-) is 45V or less. If these steps are not properly performed, the wiring will cause electric shock.</li> </ol> </li> </ul>

■ **Operations**

 <b>WARNING</b>	
 Prohibited	<ul style="list-style-type: none"> <li>• Even if this product is deactivated by the occurrence of an event such as an abnormality, when power is supplied to the inverter, do not bring any regions of your body into contact with the inverter terminals. Contact during the power-on status of the inverter can result in electric shock.</li> </ul>

 <b>CAUTION</b>	
 Prohibited	<ul style="list-style-type: none"> <li>• Do not apply a dropping shock or other physical shocks. Otherwise, damage or malfunction will result.</li> <li>• Do not yank the interconnect cable. Otherwise, damage or malfunction will result.</li> <li>• Do not disconnect the USB cable during communication with the inverter. Otherwise, damage or malfunction will result.</li> </ul>

■ **Cautions in using the unit**

<b>Notes</b>	
	<ul style="list-style-type: none"> <li>▼ Do not install the unit where it will be exposed to abrupt changes in temperature or humidity.</li> <li>▼ Leave space between the interconnect cable (between the inverter and the USB device) and the power cable from the inverter. Or the inverter could malfunction because of noise.</li> <li>▼ Do not connect the conversion unit to more than one inverter. Connect the conversion unit to either the “RS485 (2-wire type)” port or the “LOGIC” port on your inverter, depending on the type of the inverter.</li> <li>▼ Avoid connecting the conversion unit to a USB hub or extended USB port (e.g., PCMCIA card). Or else the conversion unit may become unstable, depending on the environment in which it is used.</li> <li>▼ To allow an emergency stop by means of an external device, insert a magnetic contact or similar device between the inverter and the power supply.</li> </ul>

■ **Cautions in creating a software program**

<b>Notes</b>	
	<ul style="list-style-type: none"> <li>▼ The communications software created based on the instruction manual for each TOSVERT series communication function can be used as-is, if the COM port number is changed properly. The conversion unit may, however, be detached from the operating system as a result of a transmission error due to noise, and therefore the occurrence of transmission timeout errors should be monitored using the software, and if they occur in succession, open the port again.</li> </ul>

# 1. Introduction

Thank you for purchasing a “USB-to-serial conversion unit (USB001Z unit),” an optional device for the TOSVERT series inverters.

The USB-to-serial conversion unit makes it possible to use a USB port on your computer as a COM port for connecting it to an inverter for data communications.

This instruction manual explains how to connect the USB-to-serial conversion unit, and for correct use of the USB-to-serial conversion unit. Please read this manual carefully along with the instruction manual for your inverter and the communication function manual.

When using the USB-to-serial conversion unit, keep this manual handy for future maintenance and inspections.

[Explanation about the type of the USB-to-serial conversion unit]

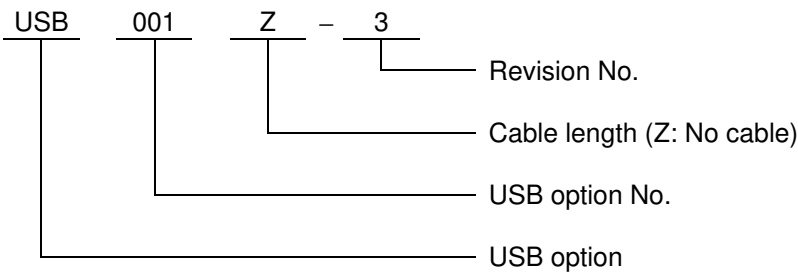

[Accessories check]

The USB-to-serial conversion unit is composed of the items listed below. Unpack the product and check for missing or damaged components.

- (1) USB-to-serial conversion unit ..... 1  
(USB001Z)

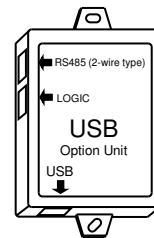

- (2) USB-to-serial Conversion Unit Instruction Manual ..... 1  
(E6581282)

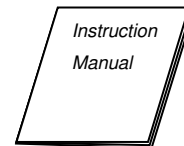

- (3) CD-ROM ..... 1

- Device driver
- Uninstaller
- Instruction Manual (Detailed version)  
(E6581298: Japanese manual, E6581299: this English manual)

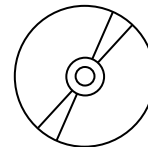

[Note]

This unit does not include an inverter-unit connection cable or a personal computer-unit connection cable. Purchase these cables separately. (Refer to page 5.)

[Trademark]

Microsoft and Windows, Windows Vista are either registered trademarks or trademarks of Microsoft Corporation in the United States and/or other countries.

Microsoft product screen shot(s) reprinted with permission from Microsoft Corporation.

## 2. Exterior features

(1) Here are the names and functions of the exterior components of the USB001Z unit.

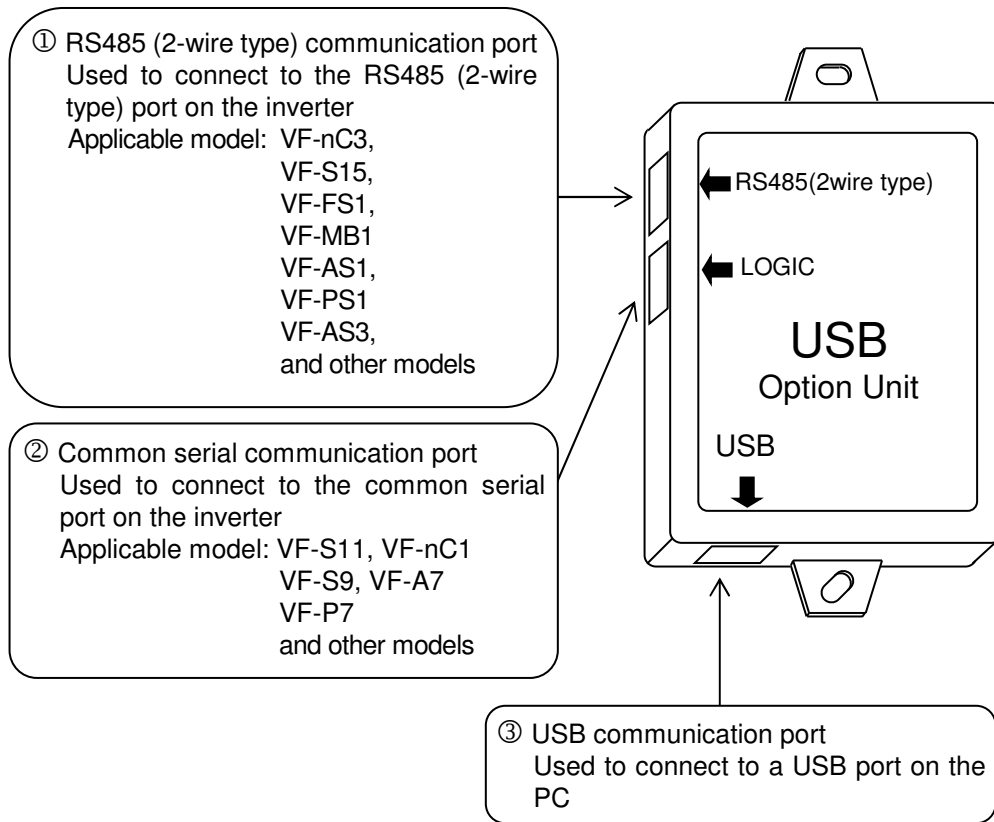

(2) Interconnect cables (No cables are included with this converter unit.)

- Inverter side (Point of connection: Either ① or ② in the above figure)

Use one of the optionally available Toshiba-specified cables listed below.

Inverter-to-unit interconnect cable	Cable length
CAB0011	1.2m
CAB0013	3.6m
CAB0015	4.8m

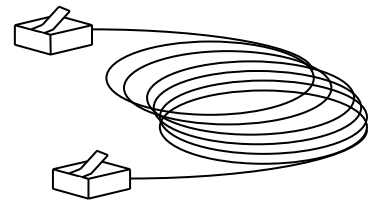

- USB device side (Point of connection: ③ in the above figure)

Use a commercially available USB cable.

(Compliant with USB 1.1/2.0, A-B connection type)

Recommended cable length: 1m or less

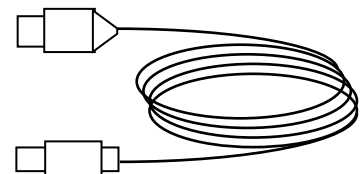

### 3. Installing the device driver

When using the USB001Z unit for the first time, you have to install its driver on your computer. These steps do not need to be performed from the next time onward.

In order to install, there are two methods shown in a table below. This manual explains both methods.

The method of using the CD-ROM of accessories	The method of using the latest installation file from your distributor.
First insert the CD-ROM delivered with USB001Z into the CD-ROM drive.	Extract the files from the .zip folder and place it in an appropriate location on your system.

The device driver (version V208 or later) does not correspond to Windows 98, so please be careful.

Applicable USB001Z device driver version for operating system.

Operating System	Applicable USB001Z device driver version	Device driver package
Windows Xp Windows Vista Windows 7	V208	CDM20802
Windows 8 Windows 10	V210	CDM21000

When the device driver of the previous version is already installed, be sure to install after uninstalling a previous version. Refer to Chapter 5 for the un-installation method.

Since the steps to be followed to install the driver vary depending on the operation system used, refer to the section that corresponds to the operating system used.

Note: Unless otherwise specified, the term “click” means “left-click” (default setting) in the following chapters.

---

## 3.1. Windows XP

---

\* In this example, Windows XP SP3 is used.

**(1) Turn on your computer and start Windows XP.**

Note: Log on to Windows XP as a computer administrator.

**(2) Connect the USB001Z unit to the computer with a USB cable.**

\* At this time, do not connect the USB001Z unit to the inverter.

The message “Found New hardware” appears on the screen of your computer monitor, and the “Found New Hardware Wizard” appears after a short while, as shown in the figure below.

Click the checkbox for “No, not this time” in the window, make sure a check mark is put in the checkbox, and then click [Next].



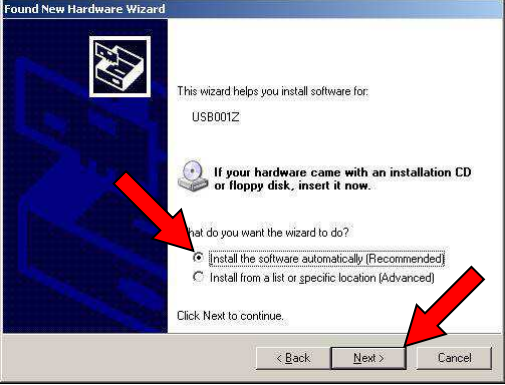
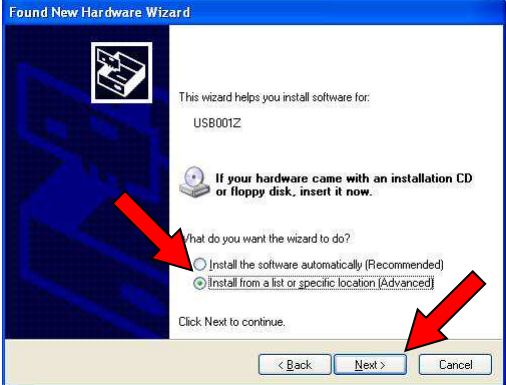
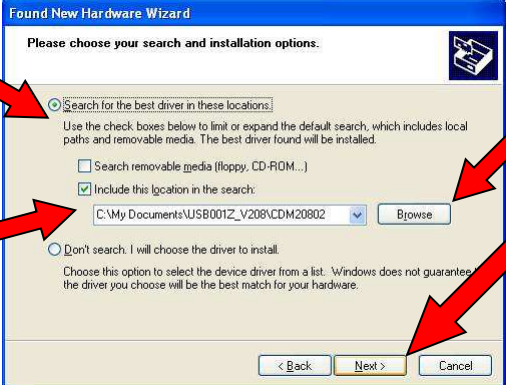

(3) Specify the path to the device driver.

<p>The method of using the CD-ROM of accessories</p>	<p>The method of using the latest installation file from your distributor</p>
<p>In the “Found New Hardware Wizard” window, click the checkbox for “Install the software automatically (Recommended)” and then click [Next].</p>  <p>The screenshot shows the 'Found New Hardware Wizard' window for USB001Z. It asks 'What do you want the wizard to do?' and has two radio button options: 'Install the software automatically (Recommended)' (which is selected) and 'Install from a list or specific location (Advanced)'. A red arrow points to the selected option, and another red arrow points to the 'Next &gt;' button at the bottom.</p>	<p>In the “Found New Hardware Wizard” window, click the checkbox for “Install from a list or specific location (Advanced)” and then click [Next].</p>  <p>The screenshot shows the 'Found New Hardware Wizard' window for USB001Z. It asks 'What do you want the wizard to do?' and has two radio button options: 'Install the software automatically (Recommended)' and 'Install from a list or specific location (Advanced)' (which is selected). A red arrow points to the selected option, and another red arrow points to the 'Next &gt;' button at the bottom.</p> <p>Click the checkbox for “Search for the best driver in these locations.” to select it, and click the checkbox for “Include this location in the search.” Browse to the folder “CDM20802” where the driver has been stored (when uncompressed). And then click [Next] to start the installation of the device driver.</p>  <p>The screenshot shows the 'Please choose your search and installation options' dialog box. It has three radio button options: 'Search for the best driver in these locations:' (selected), 'Search removable media (floppy, CD-ROM...)', and 'Don't search. I will choose the driver to install.' Under the selected option, there is a checkbox 'Include this location in the search:' which is checked. Below it, a file path 'C:\My Documents\USB001Z_V208\CDM20802' is shown in a dropdown menu, with a 'Browse' button to its right. A red arrow points to the selected radio button, another red arrow points to the checked checkbox, and a third red arrow points to the 'Next &gt;' button at the bottom.</p>

\* If the message “USB001Z has not passed Windows Logo testing to verify its compatibility with Windows XP.” appears during installation, click [Continue Anyway].

**(4) The installation of the device driver is now complete.**

On completion of the installation of serial converter driver, the window shown below appears. Then, click [Finish].



**(5) Then, the installation of the USB port driver starts.**

The “Found New Hardware Wizard” appears again. Click the checkbox for “No, not this time” in the window, and then click [Next] to start the installation of the serial port driver. Perform steps (2) through (4) again.



**(6) Complete the installation.**

The driver has been installed successfully, click [Finish] to complete the installation.



The COM port number is needed for communications with the inverter. So, check on the COM number, following the steps described in Chapter 4.

### 3.2. Windows Vista

\* In this example, Windows Vista SP2 is used.

**(1) Turn on your computer and start Windows Vista.**

Note: Log on to Windows Vista as a computer administrator.

**(2) Connect the USB001Z unit to the computer with a USB cable.**

\* At this time, do not connect the USB001Z unit to the inverter.

The message “Found New hardware” appears on the screen of your computer monitor after a short while, as shown in the figure below.

Select “Locate and install driver software (recommended)” in the window.

\* If the message “Windows needs your permission to continue” appears during installation, click [Continue].

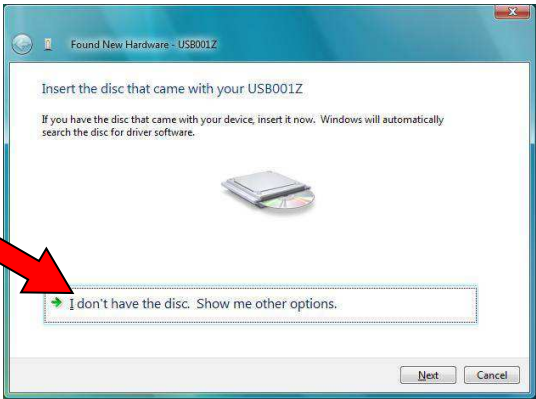
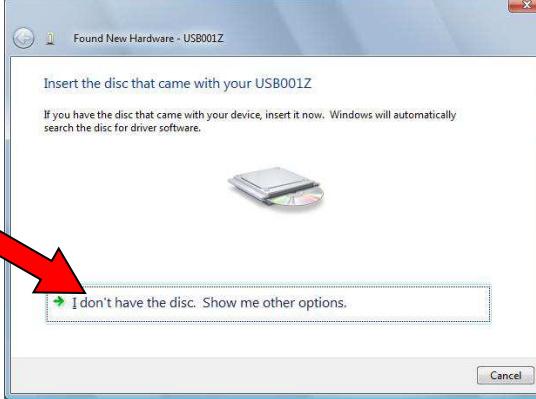

**(3) Specify the path to the device driver.**

<p>The method of using the CD-ROM of accessories</p>	<p>The method of using the latest installation file from your distributor</p>
<p>Insert the CD-ROM delivered with USB001Z into the CD/DVD drive. Then click [Next].</p> 	<p>Select “I don't have the disk. Show me other options.”</p> 

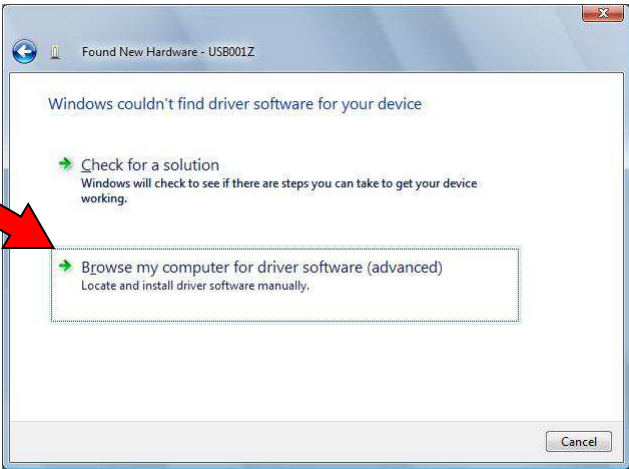
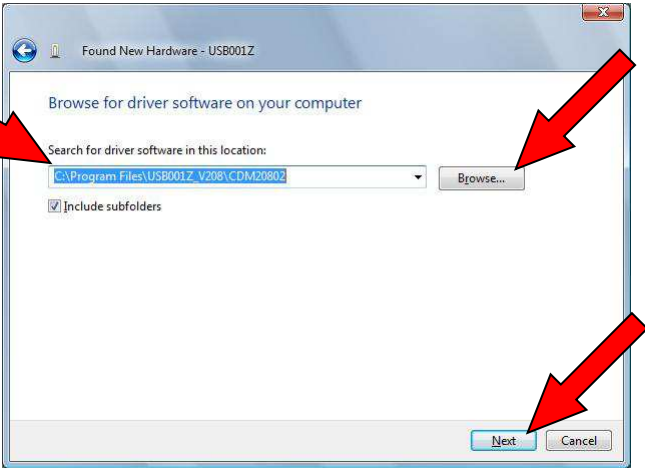
<p>The method of using the CD-ROM of accessories</p>	<p>The method of using the latest installation file from your distributor</p>
<p>-</p>	<p>Select "Browse my computer for driver software (advanced)".</p> 
<p>-</p>	<p>Browse to the folder "CDM20802" where the driver has been stored (when uncompressed) and click [Next].</p> 

\* If the message "Windows can't verify the publisher of this driver software" appears during installation, click "Install this driver software anyway".

**(4) The installation of the device driver is now complete.**

On completion of the installation, the window shown below appears. Then, click [Close].

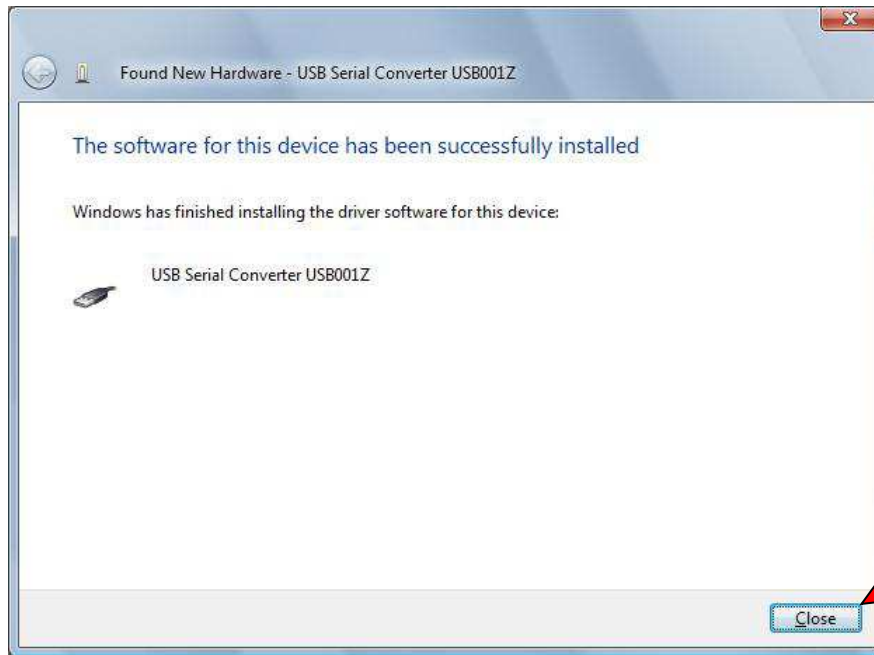
**(5) Then, the installation of the USB port driver starts.**

The "Found New Hardware Wizard" appears again.

The driver software is also in the folder "CDM20802". So, perform steps (3) again.

**(6) Complete the installation.**

The COM port number is needed for communications with the inverter. So, check on the COM number (example below shows "COM3"), when a window appears, telling you that the driver has been installed successfully. And then click [Close] to complete the installation.

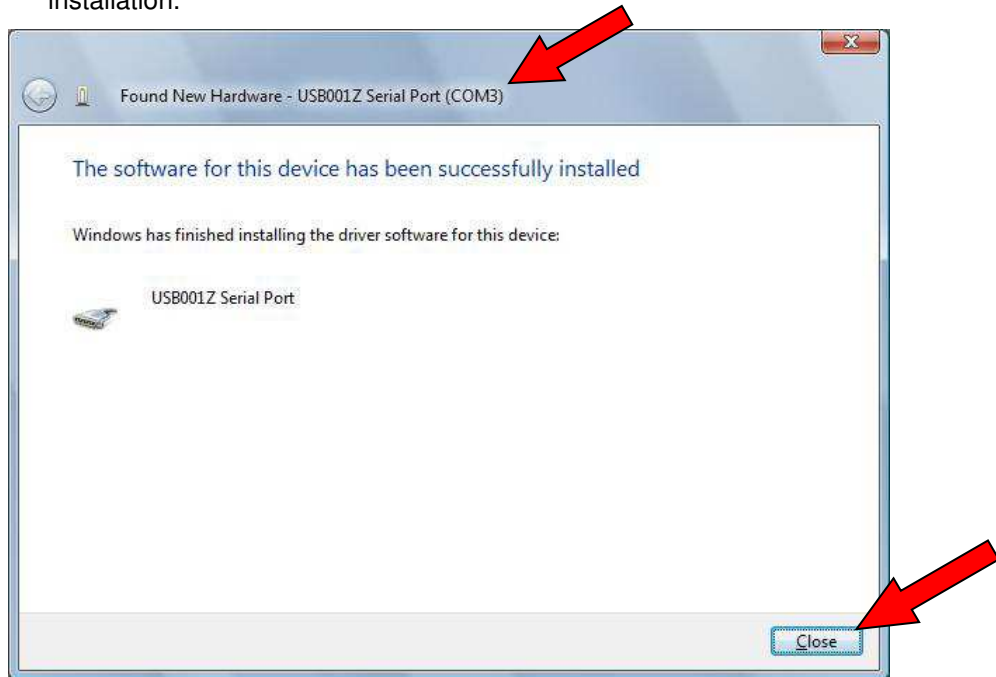

### 3.3. Windows 7

**(1) Turn on your computer and start Windows 7.**

Note: Log on to Windows 7 as a computer administrator.

If you got USB001Z\_V208.zip file for the device driver, you need to decompress it in an appropriate location on your system beforehand.

**(2) Connect the USB001Z unit to the computer with a USB cable.**

\* At this time, do not connect the USB001Z unit to the inverter.

The message "Device driver software was not successfully installed" is displayed.

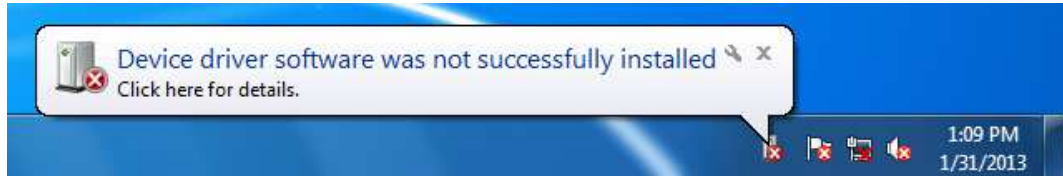

**(3) Execute Device manager.**

① Click [Start] button on Windows, RIGHT-click *Computer*, and select *Properties* from the menu that appears.

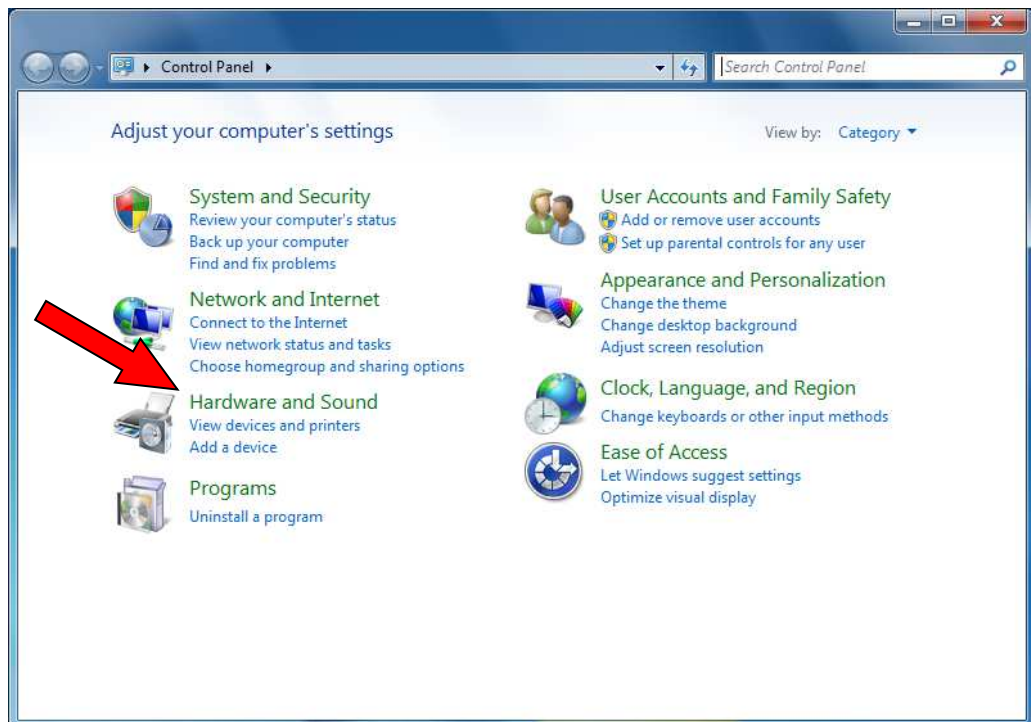



② Click *Device Manager* in *Hardware and sound*.

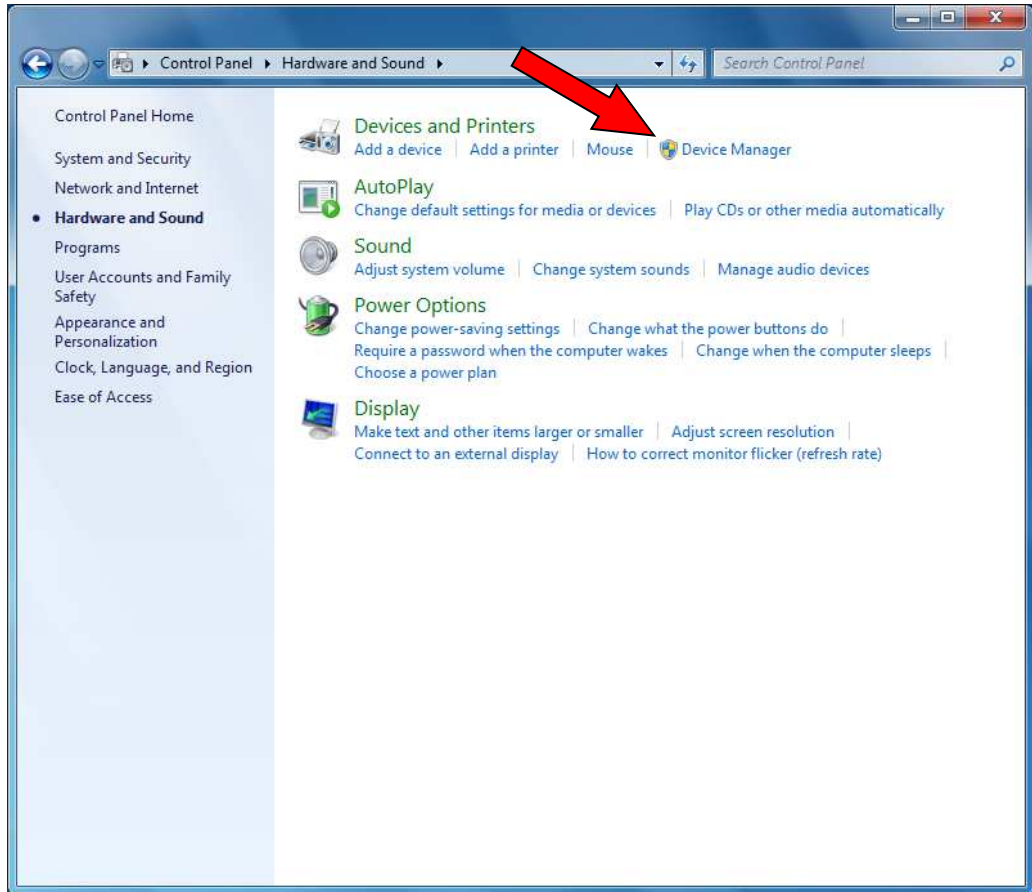

③ Right click [Other devices] - [USB001Z] in *Device Manager* and click *Update Driver Software*.

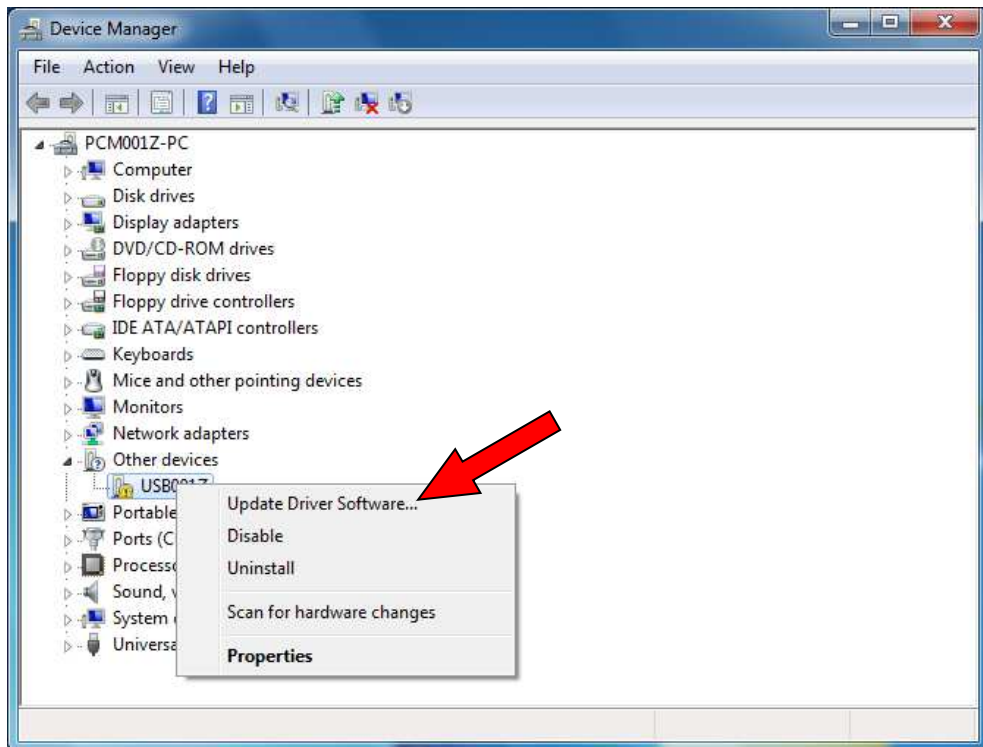

(4) Click “Browse my computer for driver software”.

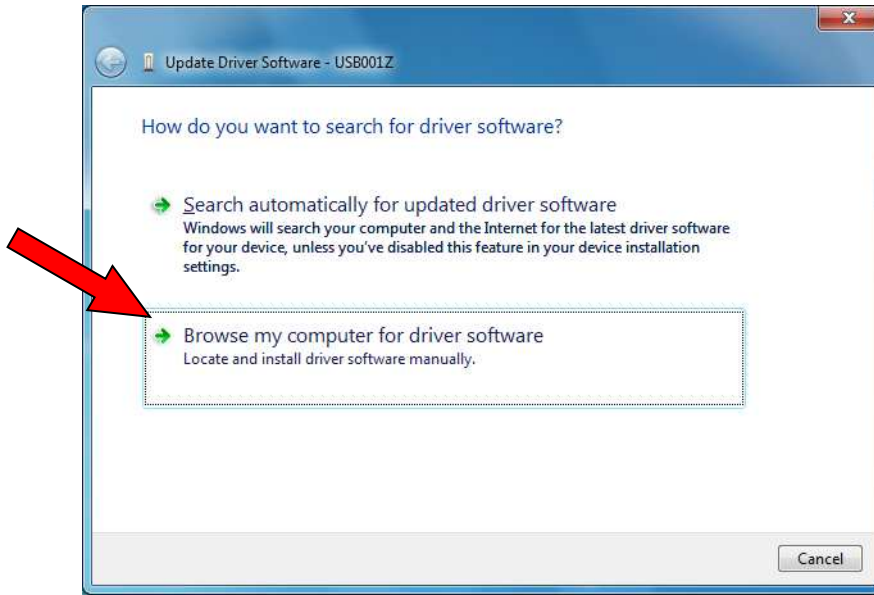

(5) Browse to the folder “CDM20802” driver has been stored and click [Next].

(The following figure shows the device driver is included in folder E:\CDM20802. Please insert bundled CD in CD-ROM drive and select the “CDM20800” folder in CD-ROM.)



**(6) Complete the USB001Z device driver installation.**

The driver has been installed successfully, click [Close] to complete the installation.

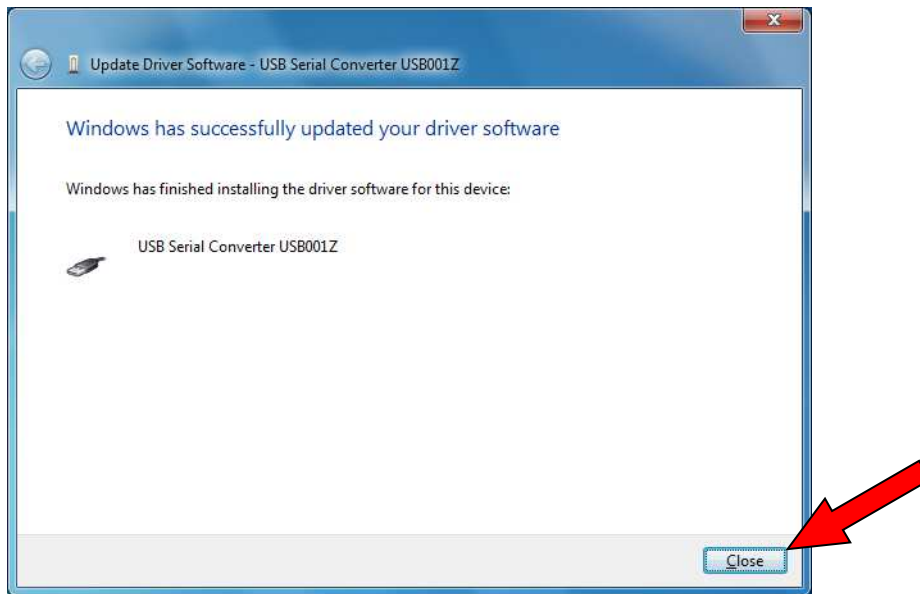

USB port driver is continuously installed.

**(7) Execute Device manager refer (3)**

Right click [Other Devices] - [USB Serial Port] in *Device Manager* and click *Update Driver Software*.

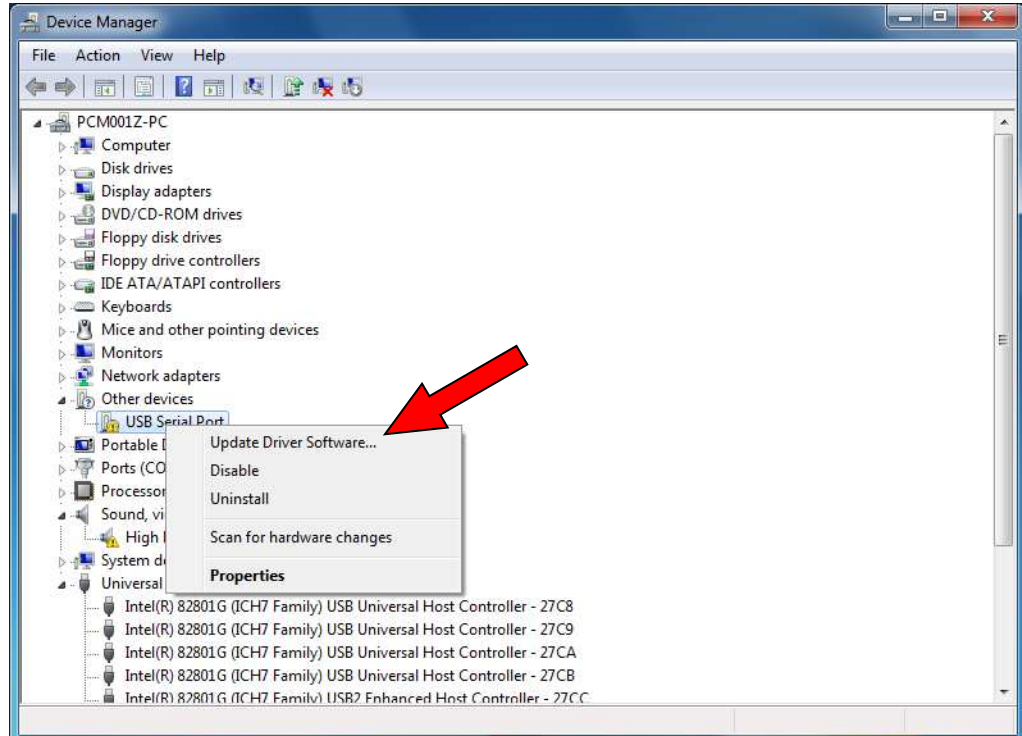

(8) Click “Browse my computer for driver software”.

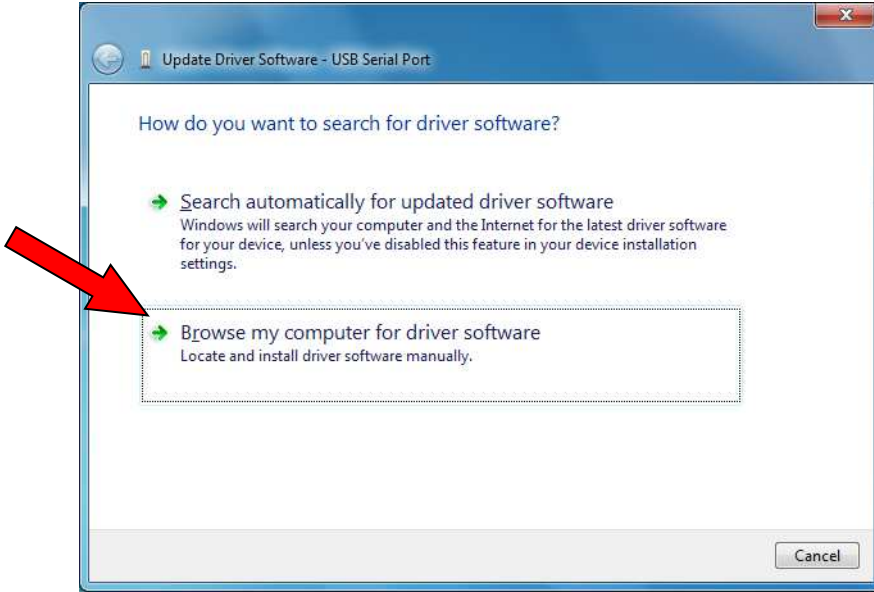

(9) Browse to the folder where USB001Z device driver has been stored and click [Next].

(The following figure shows the device driver is included in folder E:\CDM208020. Please insert bundled CD in CD-ROM drive and select the “CDM20800” folder in CD-ROM.)



**(10) Complete the USB port driver installation.**

The driver has been installed successfully, click [Close] to complete the installation.

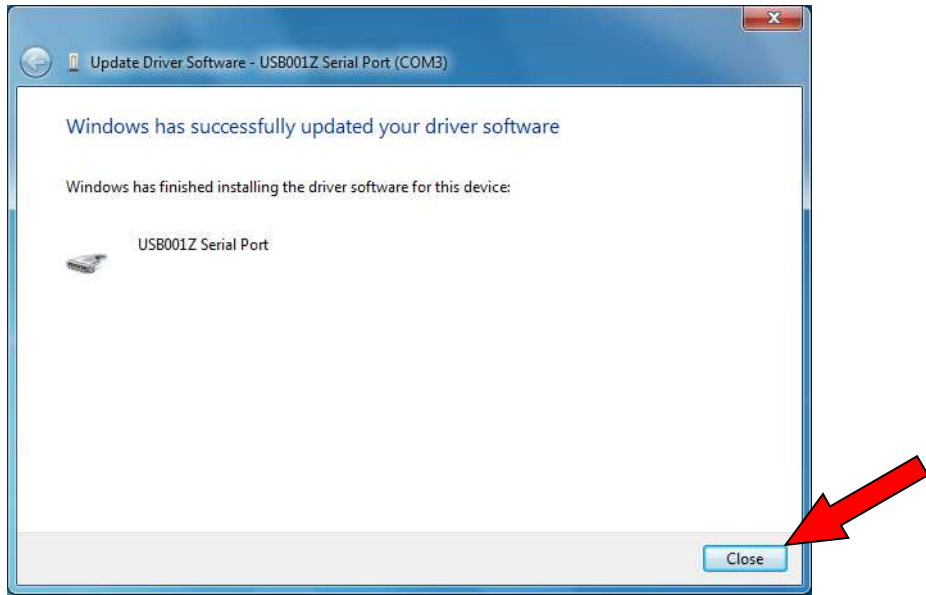

\* In the installation work, the Windows Security dialog screen appears, click "Install this driver software anyway".



---

## 3.4. Windows 8

---

**(1) Turn on your computer and start Windows 8.**

Note: Log on to Windows 8 as a computer administrator.

If you got USB001Z\_V210.zip file for the device driver, you need to decompress it in an appropriate location on your system beforehand.

**(2) Connect the USB001Z unit to the computer with a USB cable.**

\* At this time, do not connect the USB001Z unit to the inverter.

**(3) Execute Device manager.**

① Put the cursor to lower right (or top right) corner of Windows screen until the Windows Charm bar is appeared. Click *Settings*.

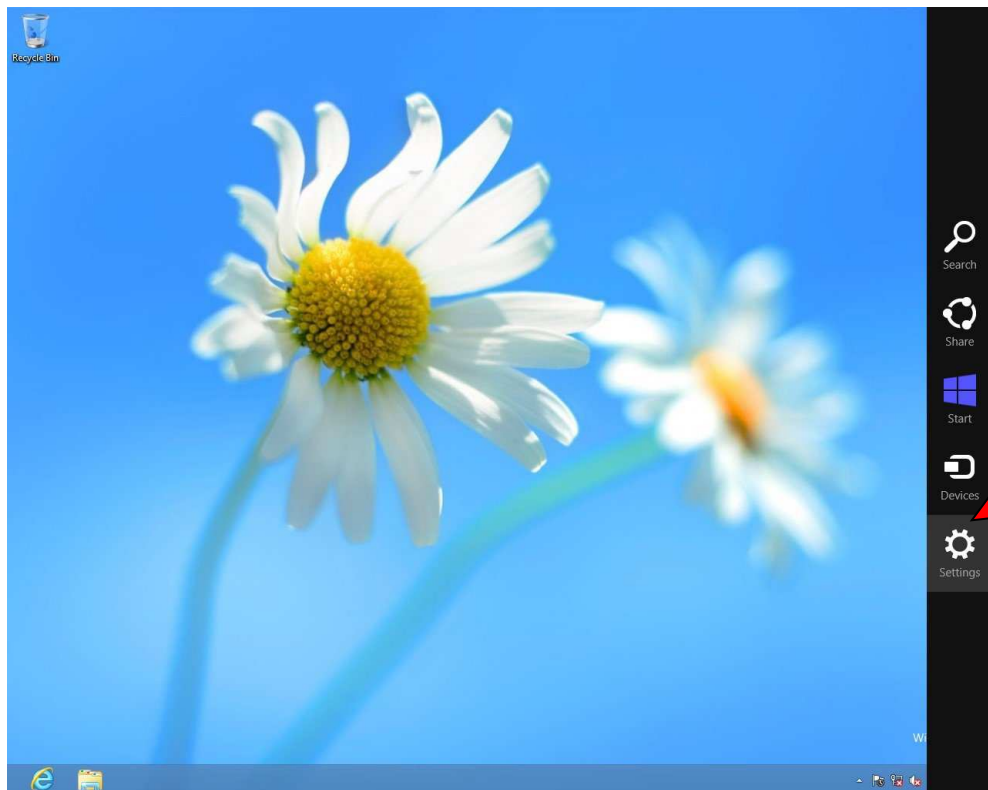

② Click *Control Panel*.

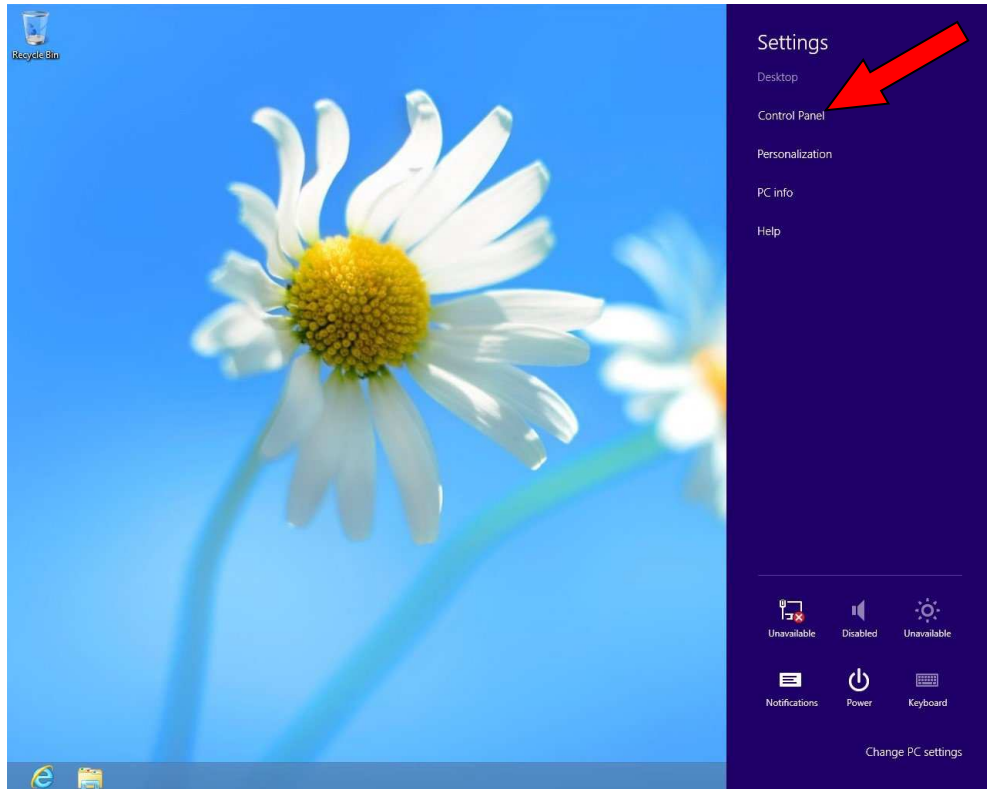

③ Click *Hardware and Sound*.

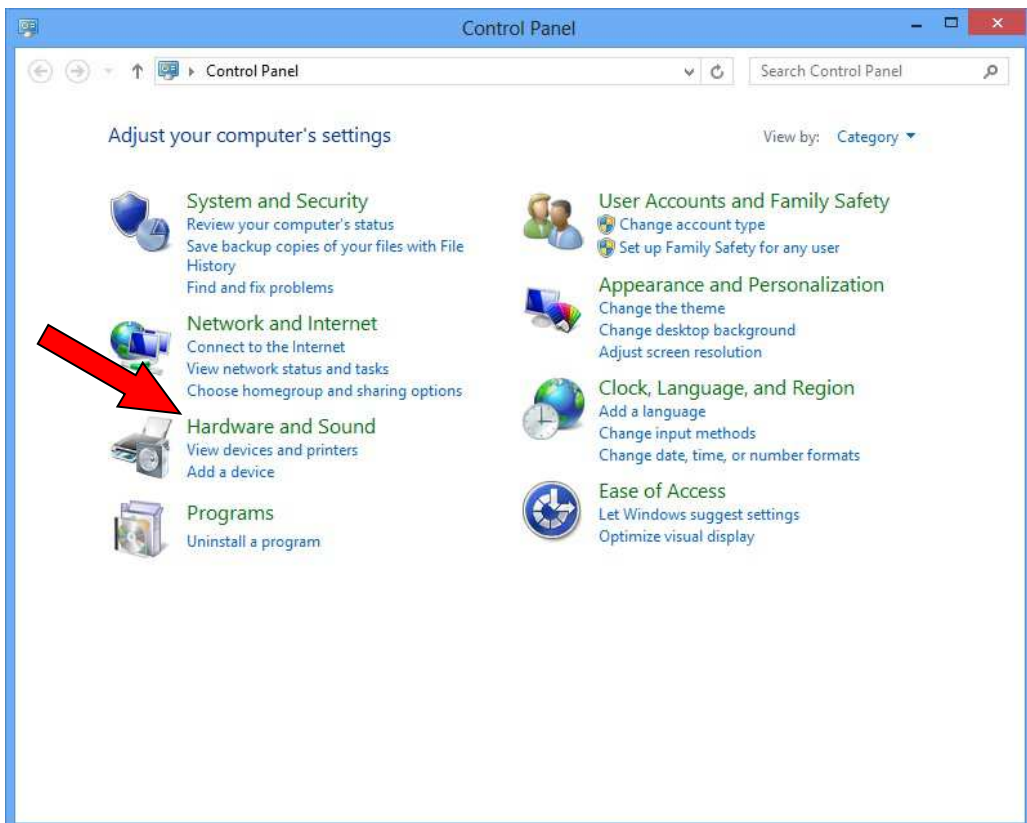

④ Click *Device Manager*.

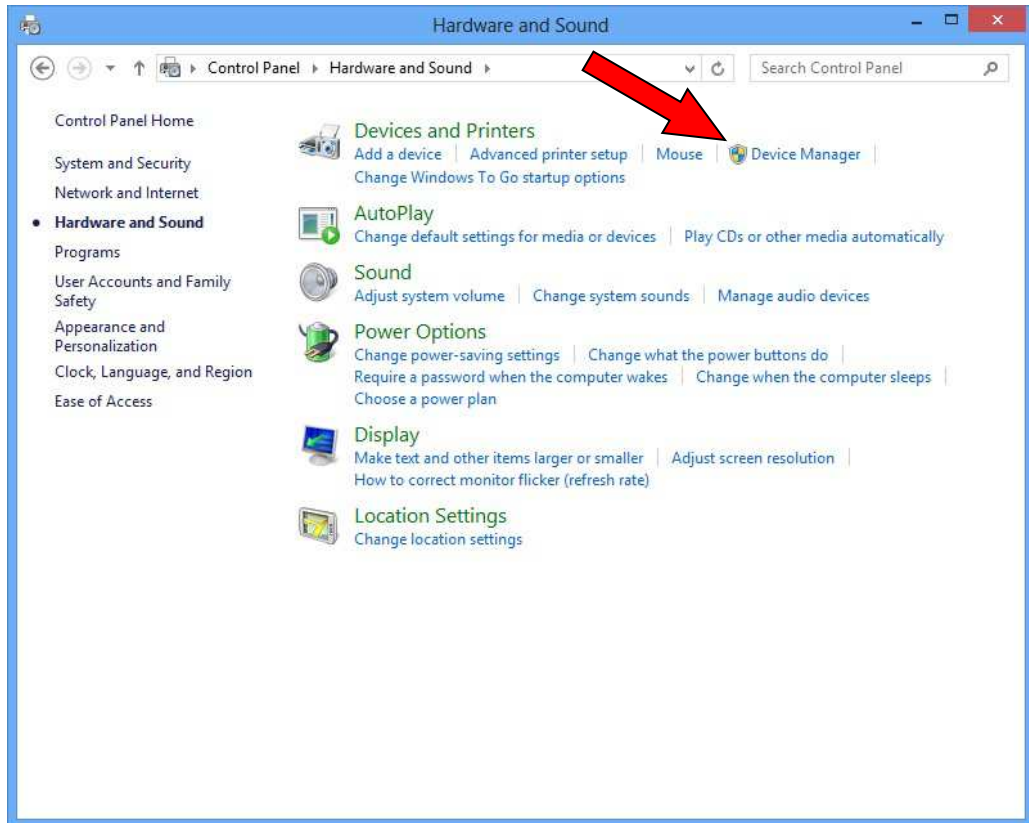

⑤ Right click [Other Devices] - [USB001Z] and click *Update Driver Software*.

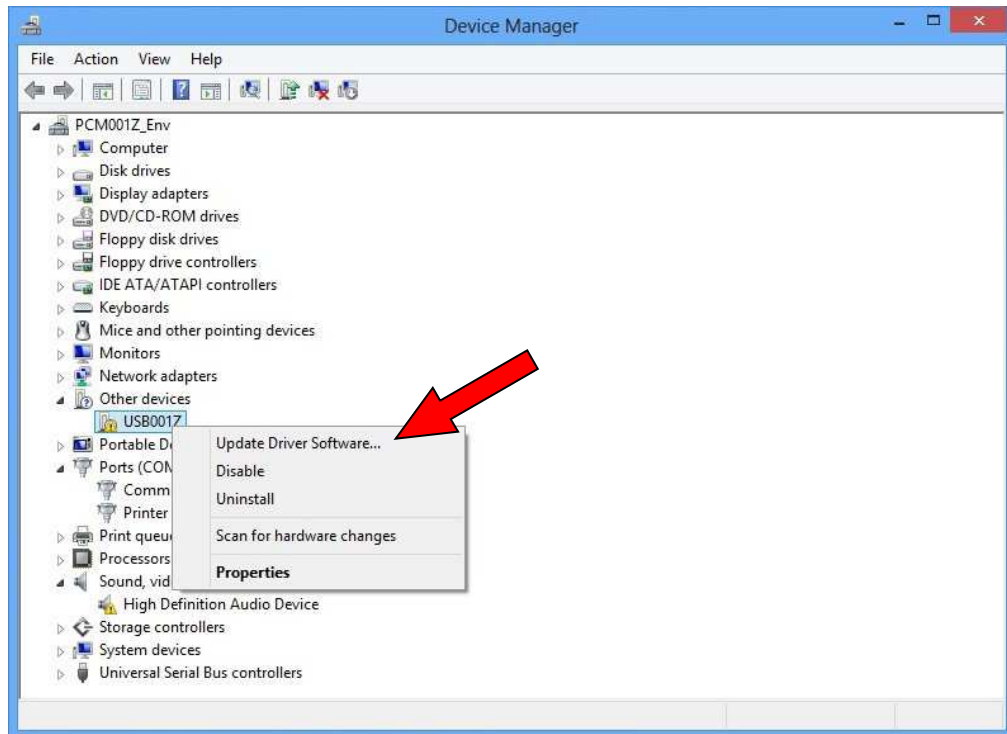



(4) Click “Browse my computer for driver software”.



(5) Browse to the folder where the driver has been stored and click [Next].

(The following figure shows the device driver is included in E:\CDM21000.  
Please insert bundled CD in CD-ROM drive and select the “CDM21000” folder in CD-ROM.)

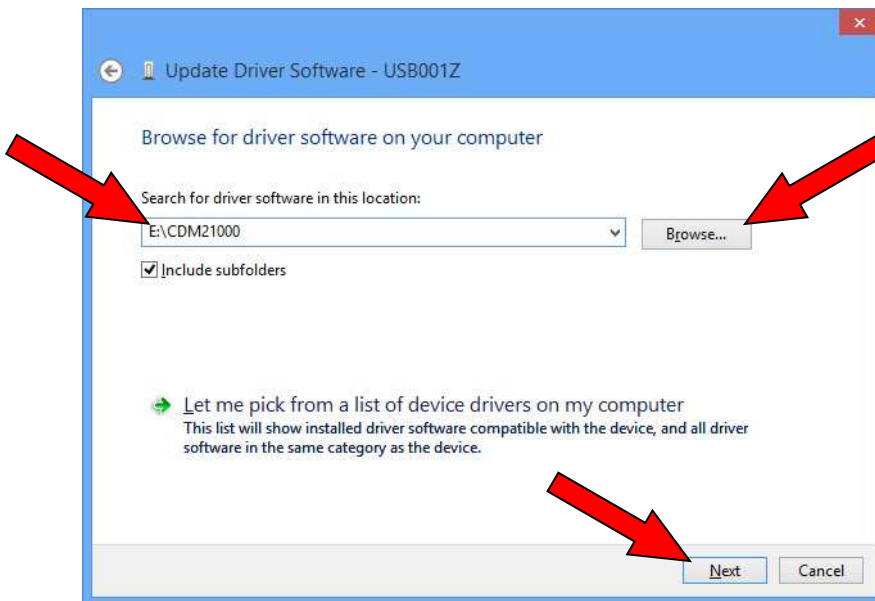

**(6) Complete the USB001Z device driver installation.**

The driver has been installed successfully, click [Close] to complete the installation.



USB port driver is continuously installed.

**(7) Execute Device manager**

Right click [Other Devices] - [USB Serial Port] in *Device Manager* and click *Update Driver Software*.

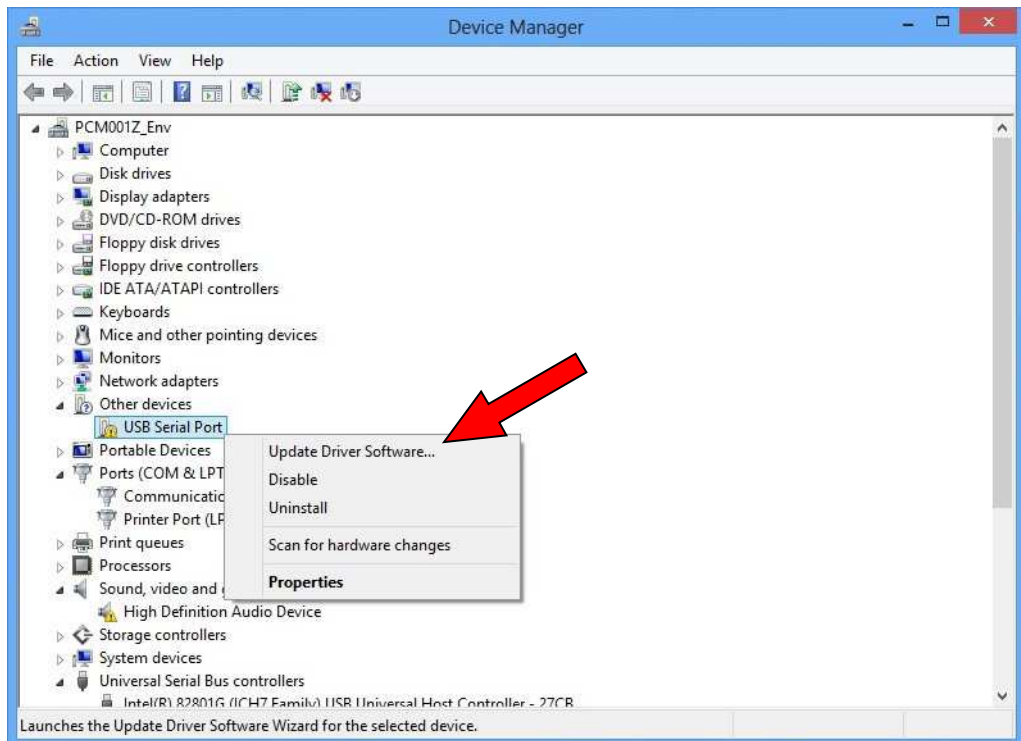

(8) Click “Browse my computer for driver software”.



(9) Browse to the folder where USB001Z device driver has been stored and click [Next].

(The following figure shows the device driver is included in folder E:\CDM21000. Please insert bundled CD in CD-ROM drive and select the “CDM21000” folder in CD-ROM.)

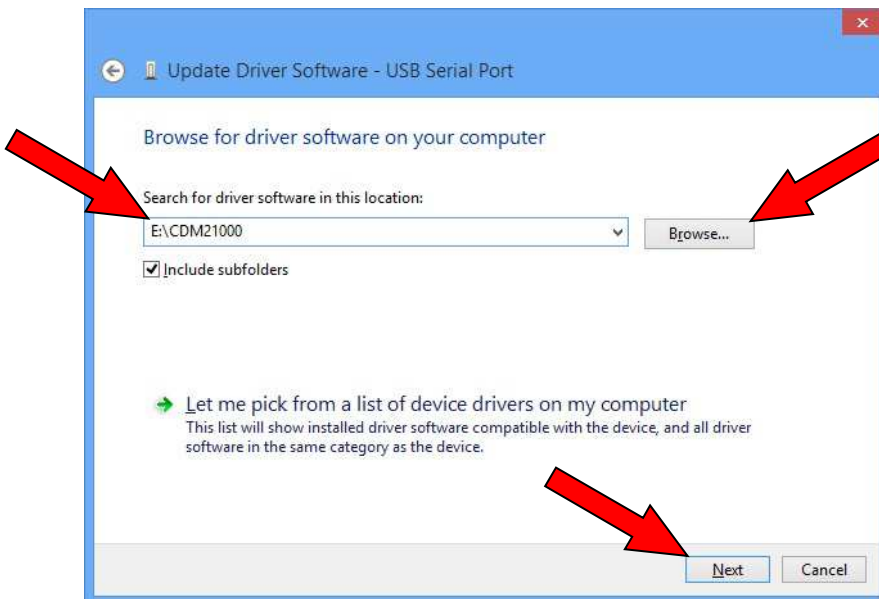

**(10) Complete the USB port driver installation.**

The driver has been installed successfully, click [Close] to complete the installation.

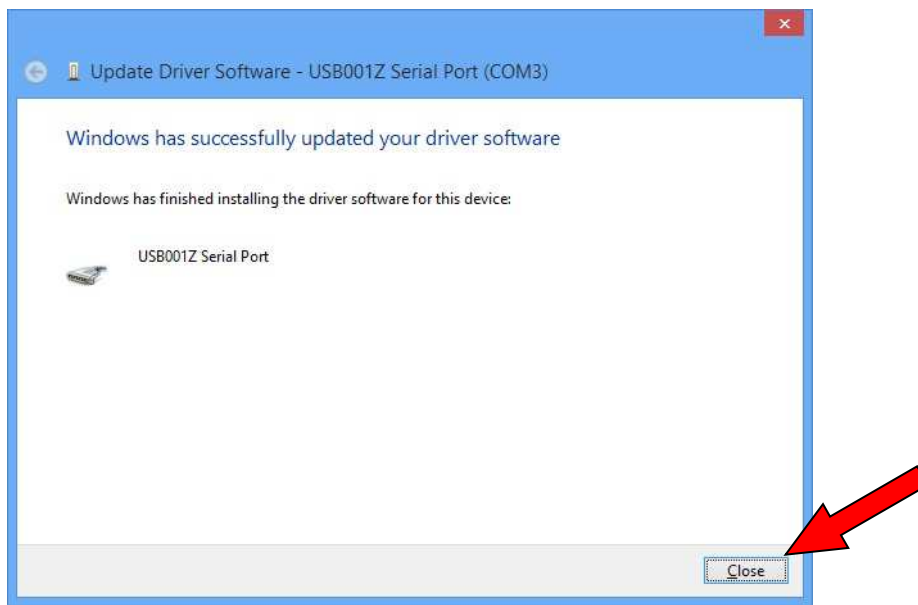

---

## 3.5. Windows 10

---

**(1) Turn on your computer and start Windows 10.**

Note: Log on to Windows 10 as a computer administrator.

If you got USB001Z\_V210.zip file for the device driver, you need to decompress it in an appropriate location on your system beforehand.

**(2) Connect the USB001Z unit to the computer with a USB cable.**

\* At this time, do not connect the USB001Z unit to the inverter.

**(3) Execute Device Manager.**

To locate the Device Manager, right click on the Microsoft logo at the bottom left corner of the screen and select Device Manager.

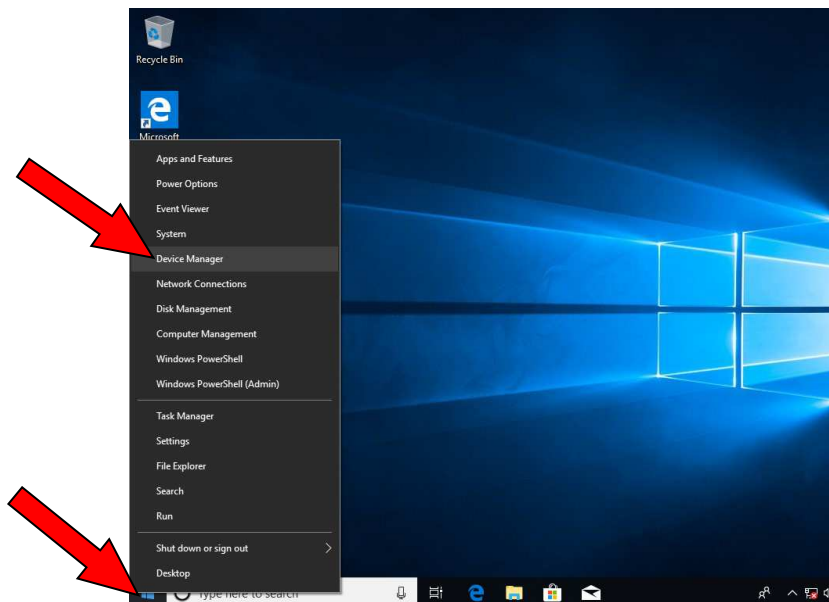

(4) In the Device Manager windows, Right click [Other Devices] - [USB001Z] and click *Update Driver*.

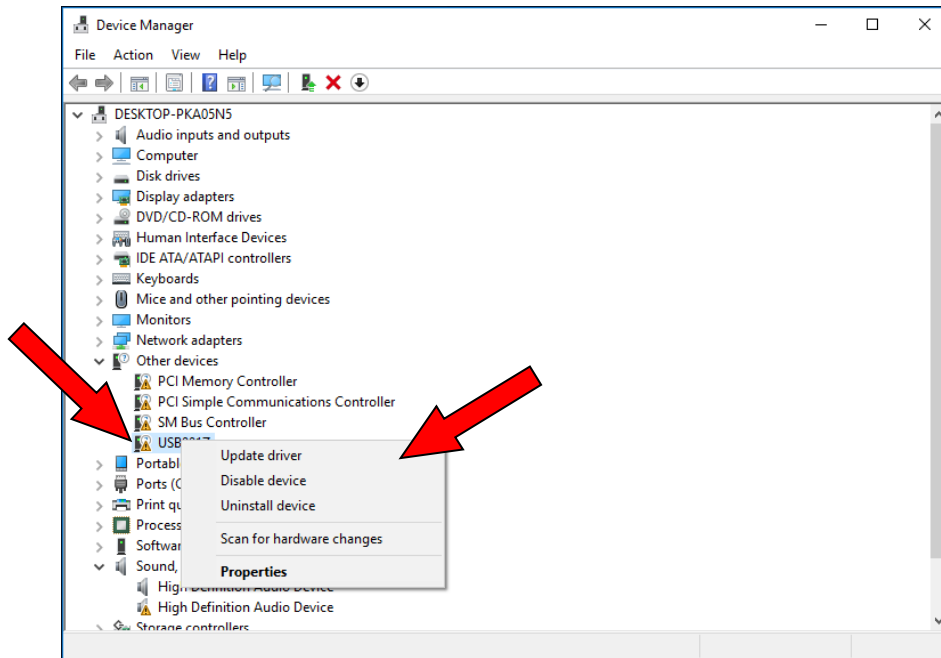

(5) Click “Browse my computer for driver software”.

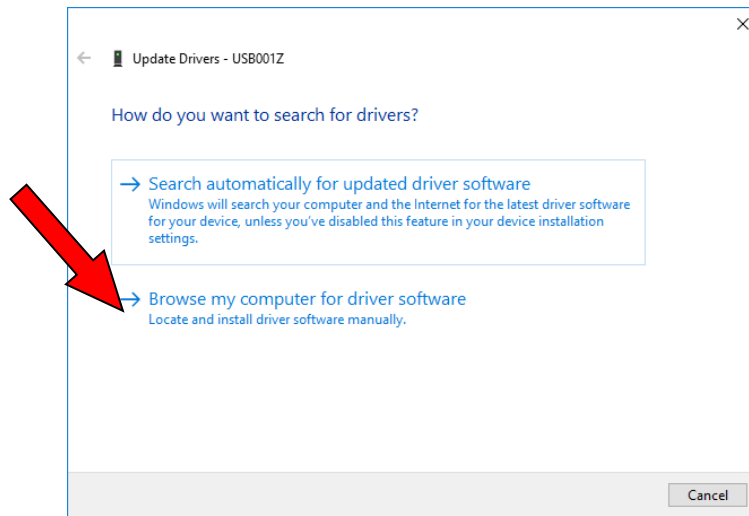

**(6) Browse to the folder where the driver has been stored and click [Next].**

(The following figure shows the device driver is included in E:\CDM21000.

Please insert bundled CD in CD-ROM drive and select the “CDM21000” folder in CD-ROM.)

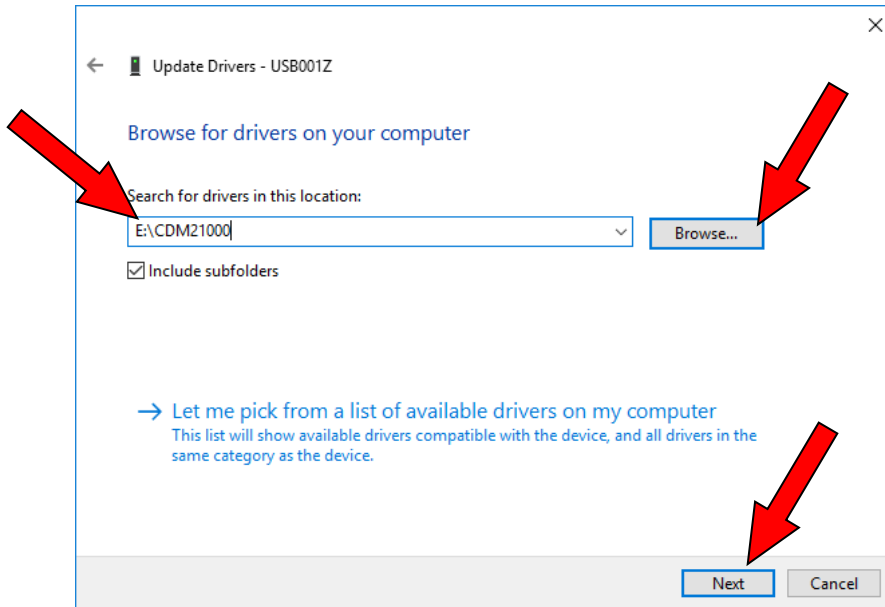

**(7) Complete the USB001Z device driver installation.**

The driver has been installed successfully, click [Close] to complete the installation.

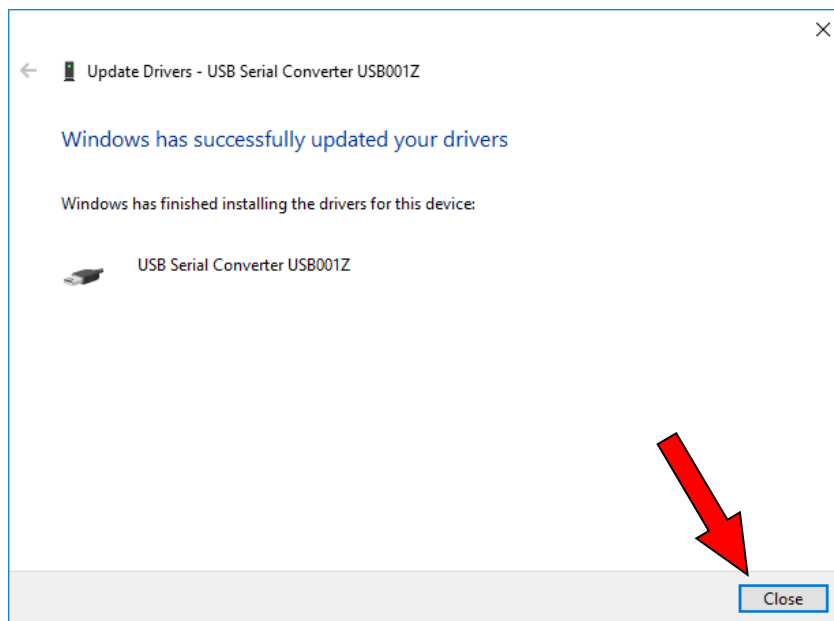

USB port driver is continuously installed.

**(8) Execute Device manager**

Right click [Other Devices] - [USB Serial Port] in *Device Manager* and click *Update Driver*.

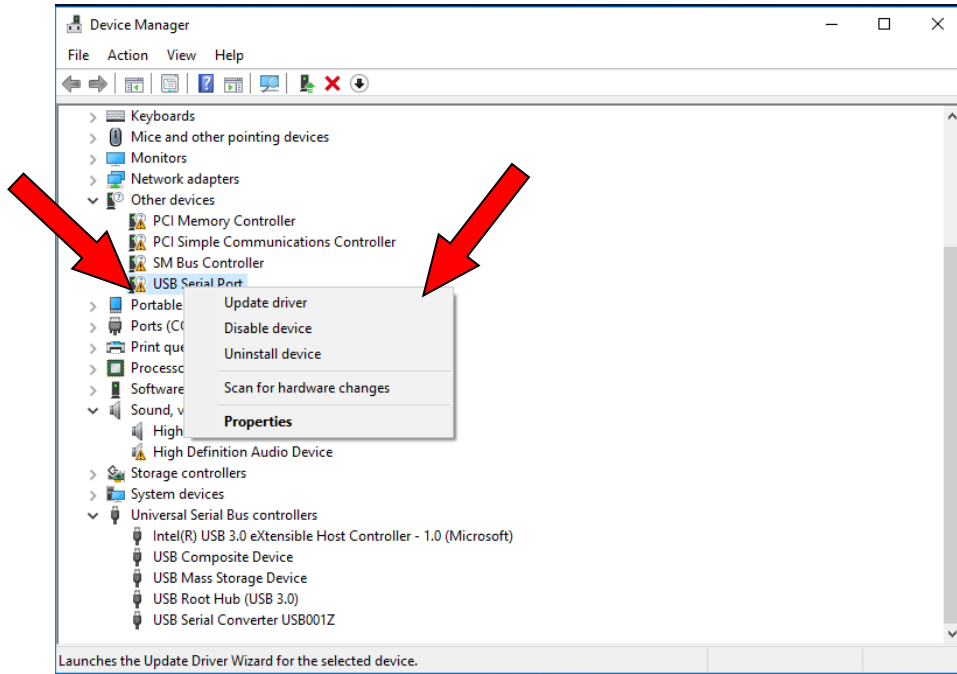

**(9) Click “Browse my computer for driver software”.**

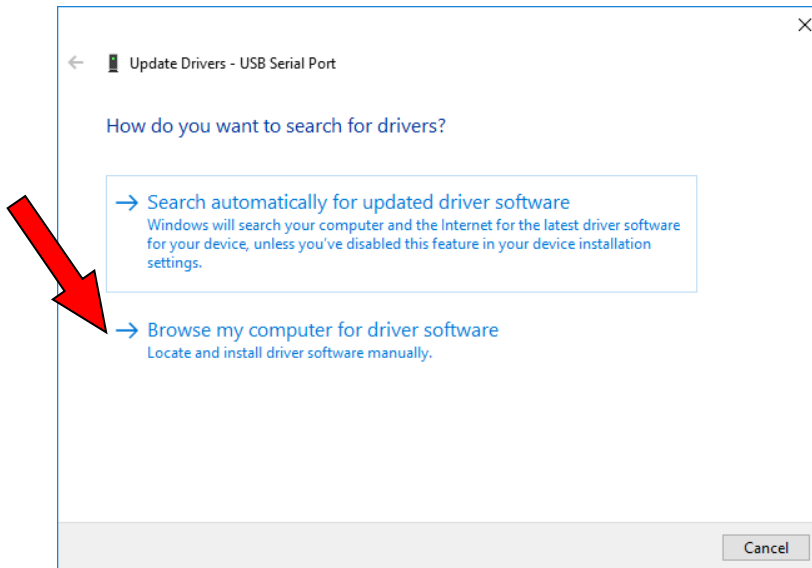



(10) Browse to the folder where USB001Z device driver has been stored and click [Next].

(The following figure shows the device driver is included in folder E:\CDM21000. Please insert bundled CD in CD-ROM drive and select the "CDM21000" folder in CD-ROM.)

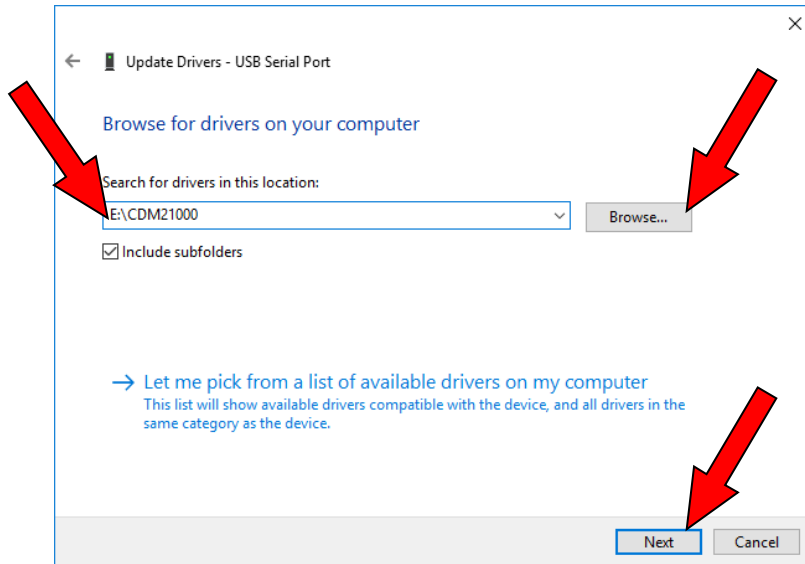

(11) Complete the USB port driver installation.

The driver has been installed successfully, click [Close] to complete the installation.

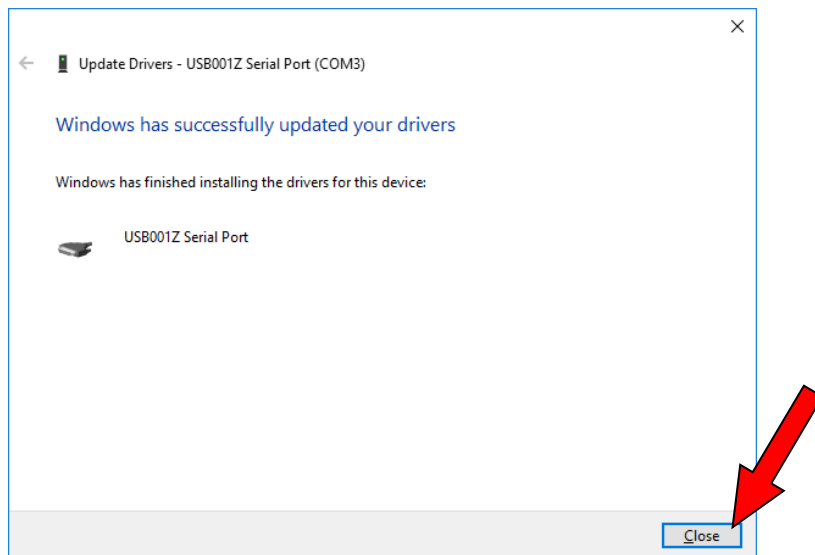

---

## 4. Checking the COM port number

---

The COM port number is needed for communications with the inverter. So, follow these steps to check on it.

The COM port number is recognized automatically when the installation of the device driver is completed. COM port numbers vary depending on how your computer is set up.

\* Perform this check with the USB001Z unit connected to your computer, or else the port number cannot be checked.

Since the steps to be followed to check the number vary depending on the operation system used, refer to the section that corresponds to the operating system used.

---

### 4.1. Windows XP

---

(1) Click [Start] button on Windows XP, RIGHT-click *My Computer*, and select *Properties* from the menu that appears.

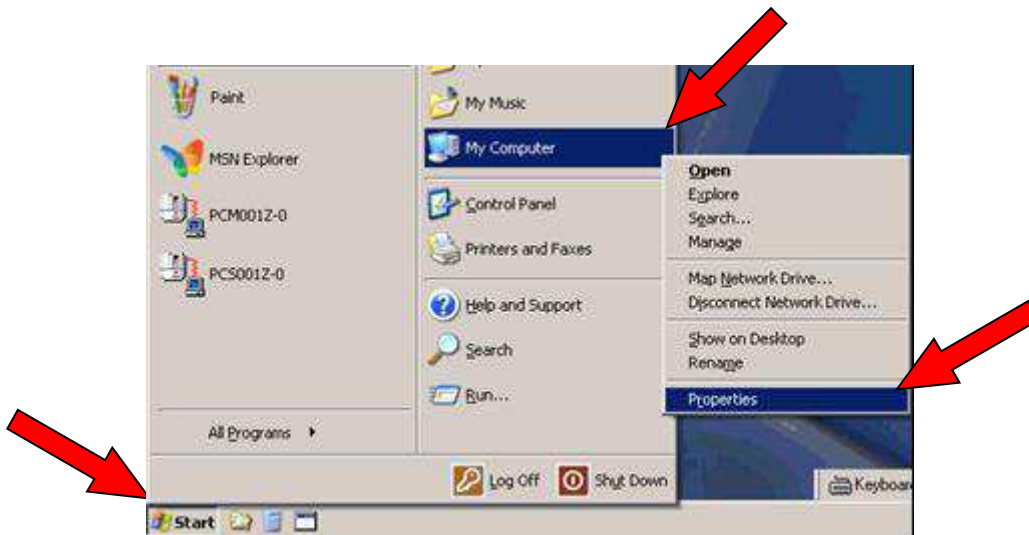

(2) Click the [Hardware] tab of the *System Properties* dialog box.



(3) Click the [Device manager] button in the [Hardware] tab.



(4) Click the [+] sign on the left side of “Port (COM&LPT).”

The number in parentheses next to “USB/Serial Port” refers to the COM port number.

(In the example shown below, the COM port number is “COM3.”)

\* If the USB001Z unit is not connected, no COM port number is shown.

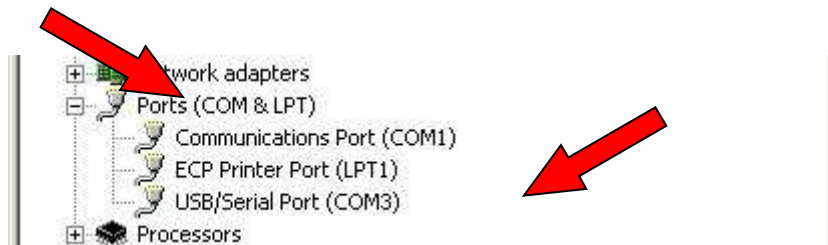

## 4.2. Windows Vista, 7

- (1) Click “Start” button on Windows Vista, RIGHT-click *Computer*, and select *Properties* from the menu that appears.

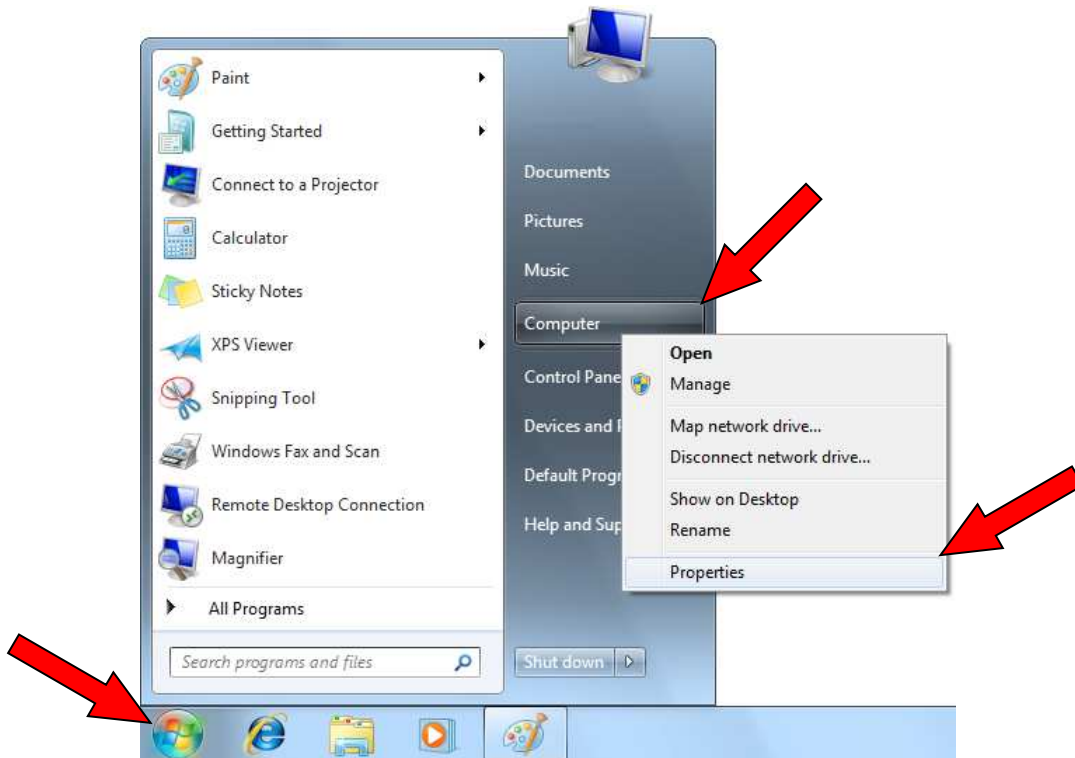

- (2) Click the *Device Manager* of the “System” dialog box.

\* If the message “Windows needs your permission to continue” appears during installation, click [Continue].



**(3) Click the "▷" sign on the left side of "Port (COM&LPT)."**

The number in parentheses next to "USB/Serial Port" refers to the COM port number. (In the example shown below, the COM port number is "COM3". If the USB001Z unit is not connected, no COM port number is shown.)

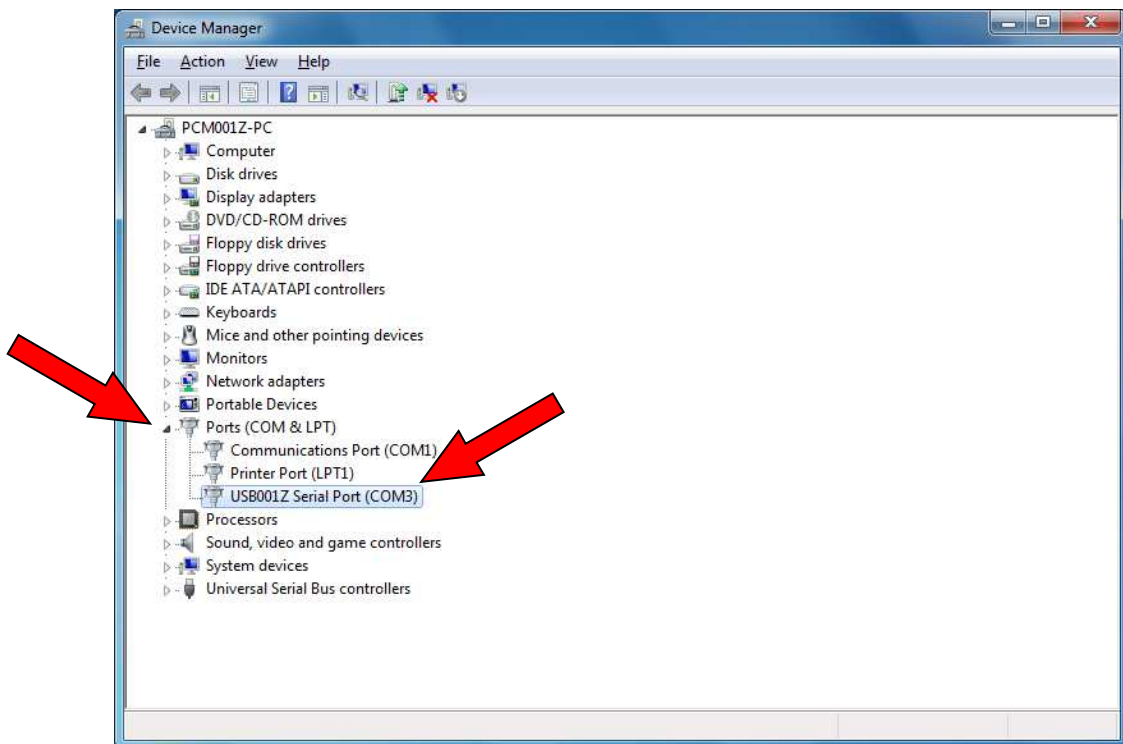

---

### 4.3. Windows 8

---

(1) Put the cursor to lower right (or top right) corner of Windows screen until the Windows Charm bar is appeared. Click *Settings*.

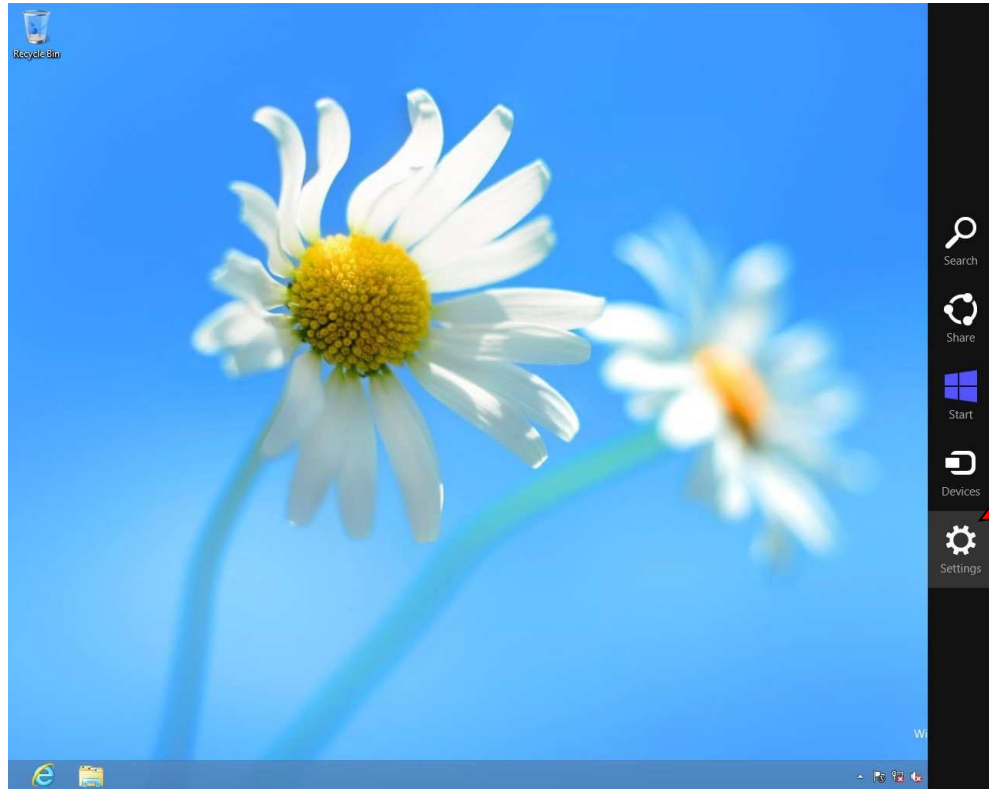

(2) Click *Control Panel*.

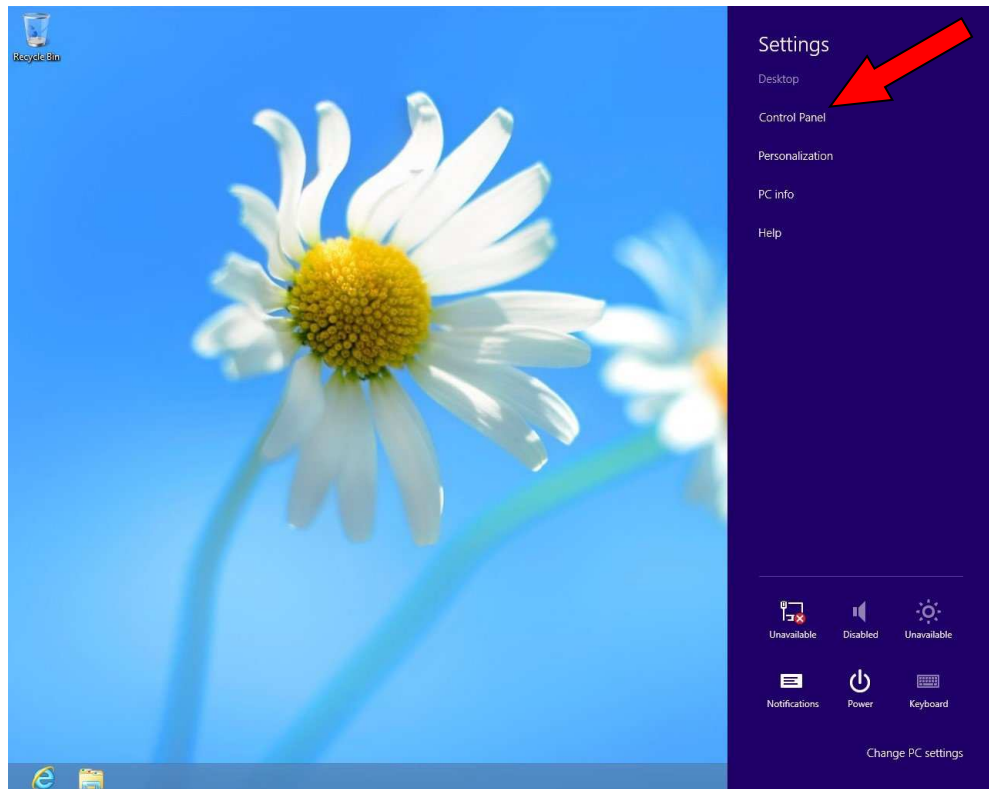

(3) Click **Hardware and Sound**.

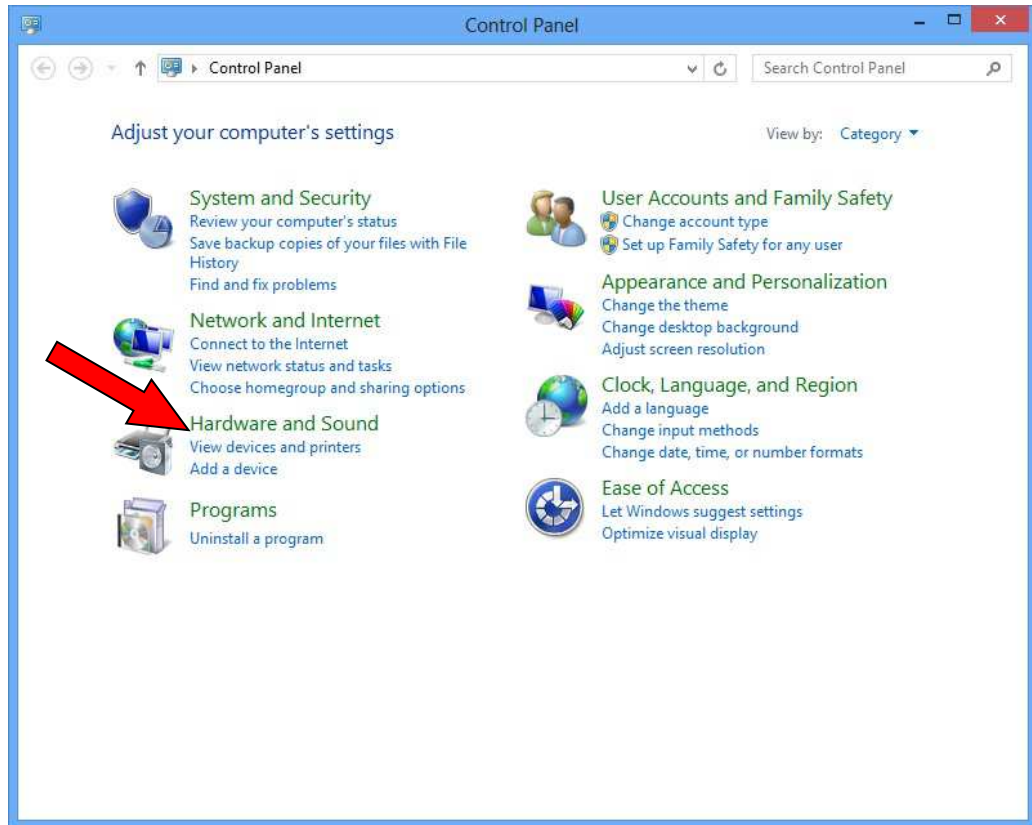

(4) Click **Device Manager**.

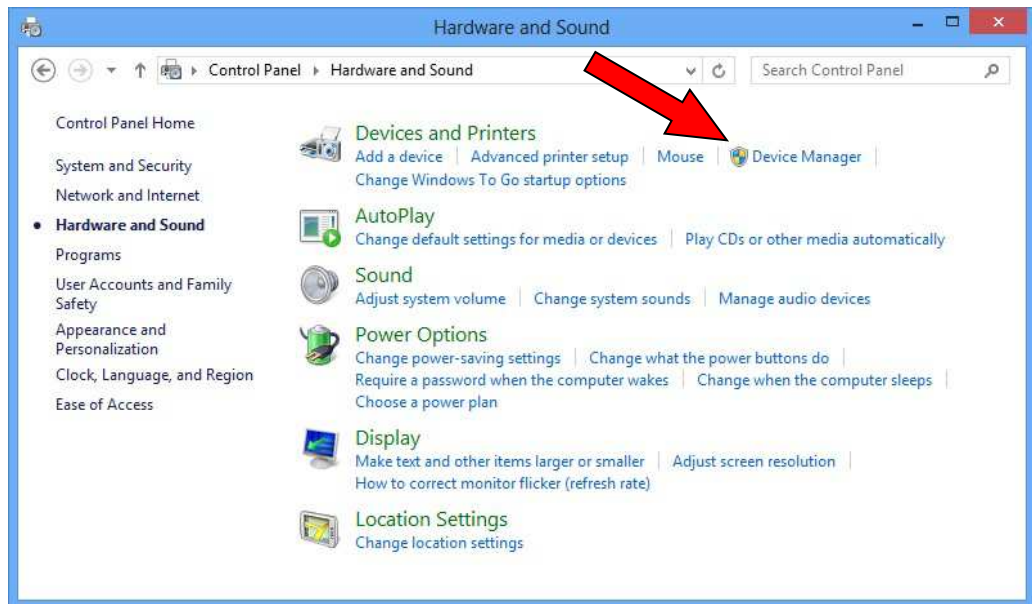

(5) Device Manager is opened.

In this case, COM port number of USB001Z is “COM3”.

\* When USB001Z is not connected to PC, it does not appear.

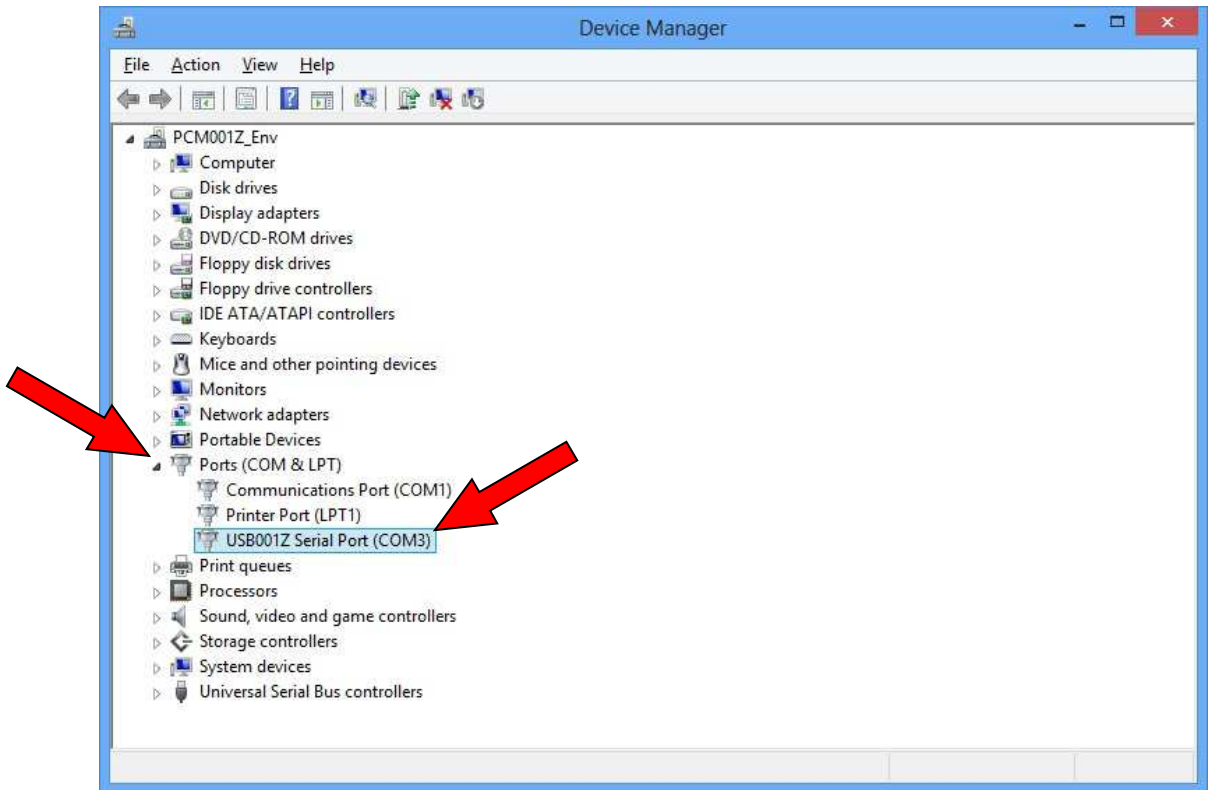



## 4.4. Windows 10

- (1) Right click on the Microsoft logo at the bottom left corner of the screen and select Device Manager.

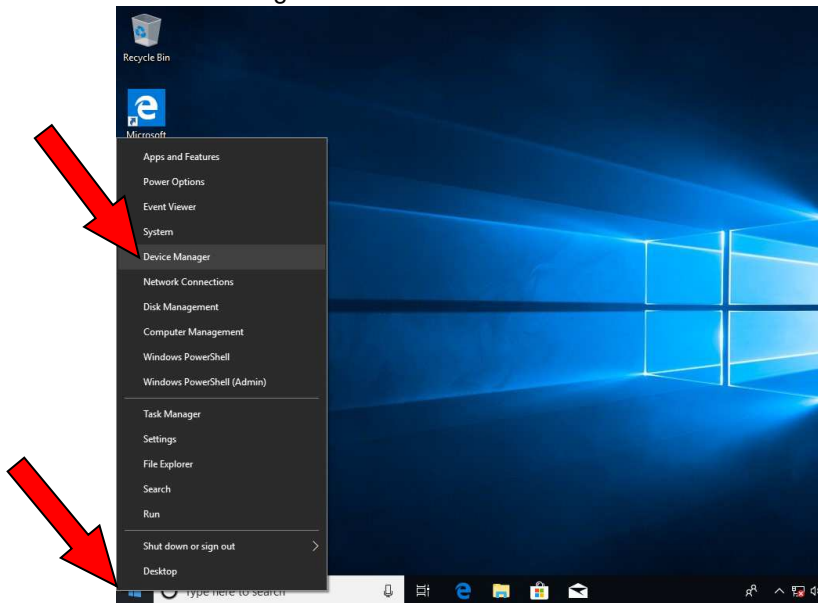

- (2) Click the "▷" sign on the left side of "Port (COM&LPT)."

The number in parentheses next to "USB001Z Serial Port" refers to the COM port number. (In the example shown below, the COM port number is "COM3". If the USB001Z unit is not connected, no COM port number is shown.)

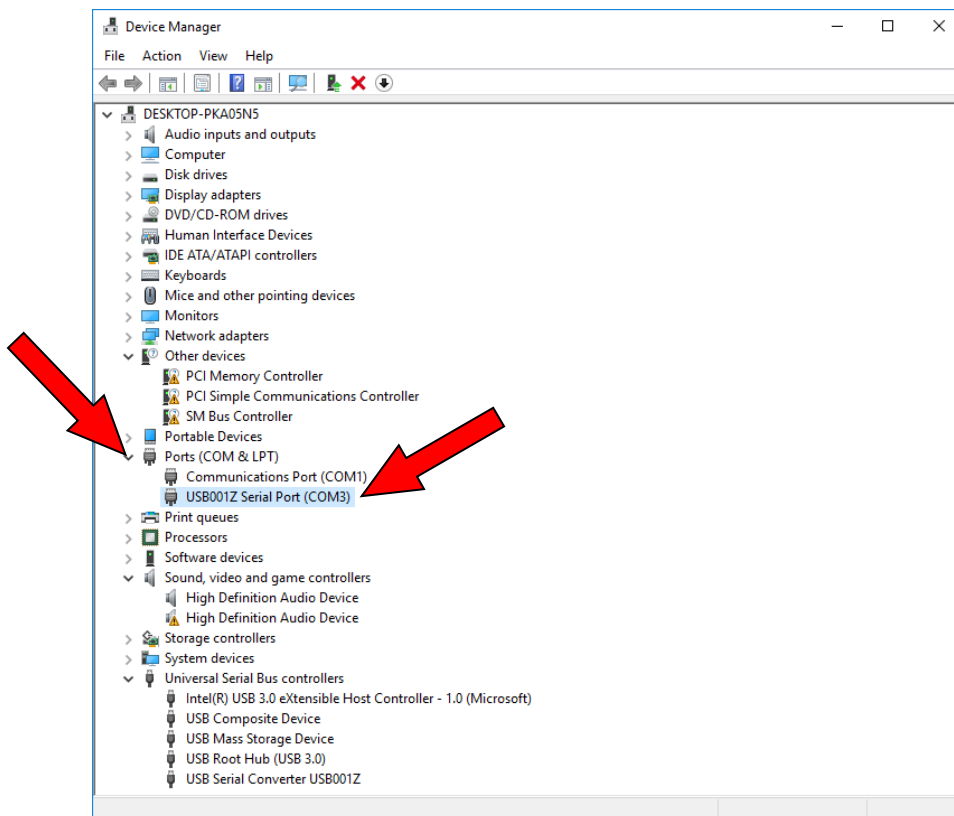

## 5. Uninstalling the device driver

Not to be able to install normally and to return the personal computer to the state before the device driver is installed, it's uninstalled.

Since the steps to be followed to uninstall the driver vary depending on the operation system used, refer to the section that corresponds to the operating system used.

### 5.1. Windows XP

The uninstall application is used. The un-installation can start even when the conversion unit is connected to the computer. The following is a step by step for using uninstaller on the CD-ROM or in the downloaded files.

The method of using the CD-ROM of accessories	The method of using the latest installation file from your distributor
Insert the CD-ROM delivered with USB001Z into the CD-ROM drive. Click "My Computer", and then click your CD-ROM drive. Open the folder named "USB001Z_V208".	Extract the files from the .zip folder and place it in an appropriate location on your system.

- (1) To run the CDM Uninstaller, simply double click on the file "CDMUninstallerGUI.exe" in the folder "CDMUninstaller\_v1.4" on your system. (when uncompressed)

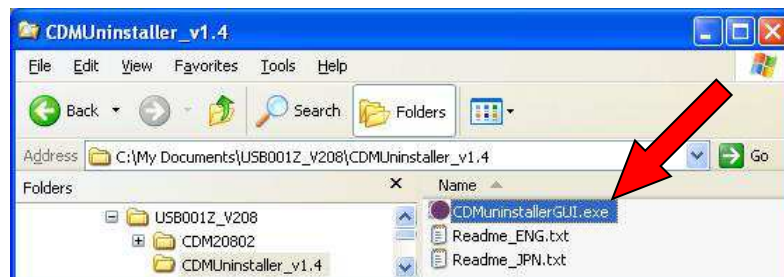

- (2) To remove a device driver for USB001Z, confirm Vendor ID is "0403" and input "E040" into Product ID text box. And then click [Add] button.

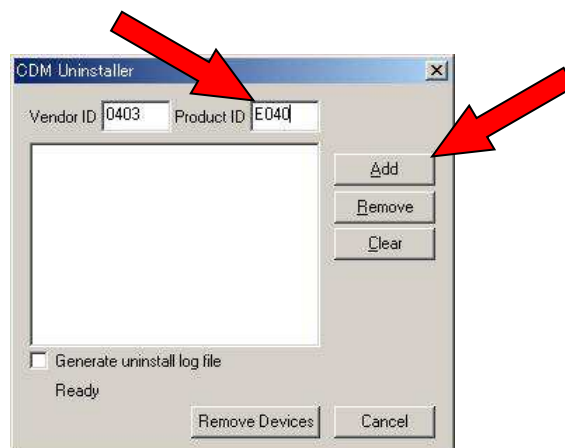

(3) To remove the device, click on the [Remove Devices] button.

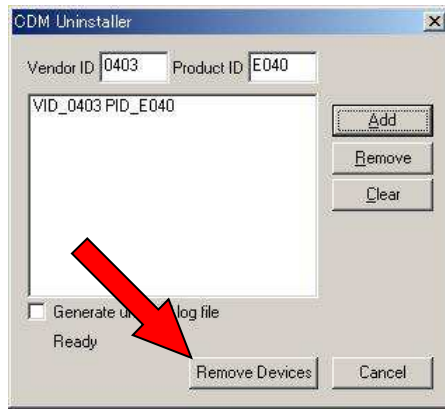

(4) A message box will confirm successful removal from the system and the device will be removed from the device window. Click [OK].



(5) Click [Cancel] to complete the un-installation.



## 5.2. Windows Vista, 7

Two drivers can be removed using the *Device Manager*. Do not reverse following (3) (5) in the order by which the driver software are deleted.

**(1) Connect the USB001Z unit to the computer with a USB cable.**

\* At this time, do not connect the USB001Z unit to the inverter.

**(2) Open the Device Manager.**

Click "Start" button on Windows, RIGHT-click "Computer," and select *Properties* from the menu that appears. And then click the *Device Manager* of the "System" dialog box. For details, refer to section 4.2.

**(3) Click the "▷" sign on the left side of "Port (COM&LPT)".**

Select "USB001Z Serial Port", right-click on the mouse and select *Uninstall*.

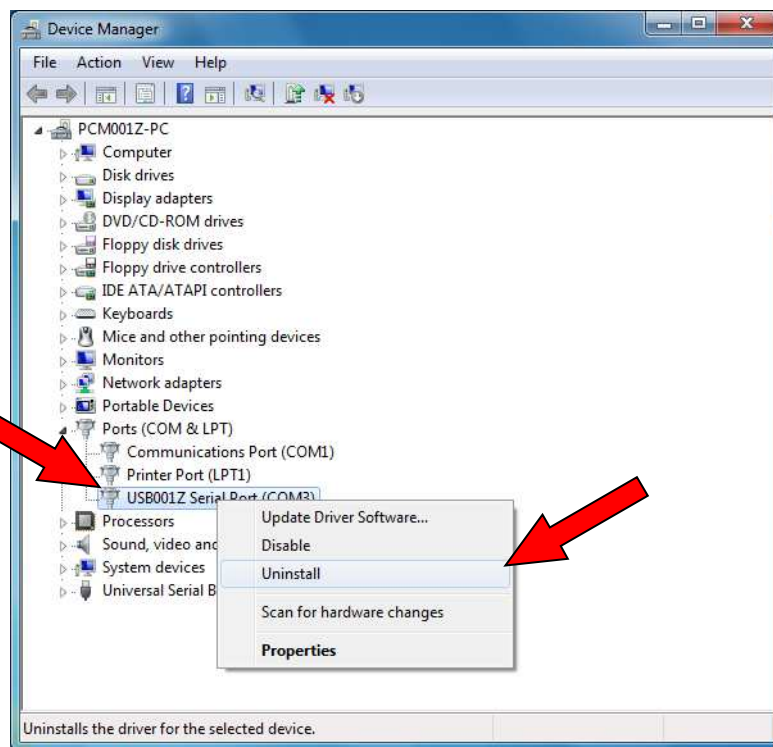

**(4) Click the checkbox for "Delete the driver software for this device" on the uninstall dialog box and then click [OK].**



(5) Click the "▷" sign on the left side of "Universal Serial Bus Controllers".

Select "USB001Z Serial Converter USB001Z", right-click on the mouse and select *Uninstall*.

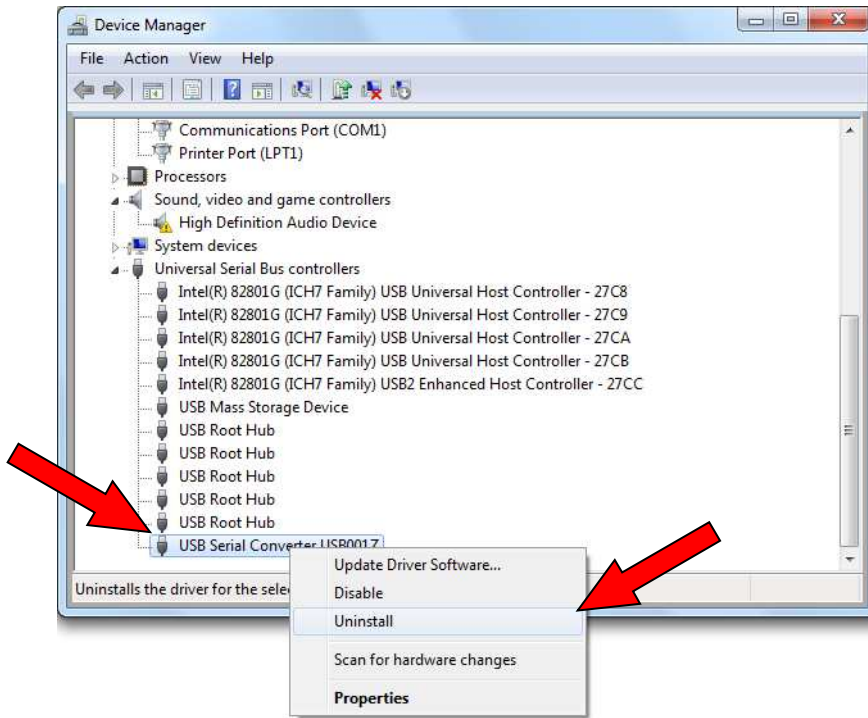

(6) Click the checkbox for "Delete the driver software for this device" on the uninstall dialog box and then click [OK].



(7) Disconnect the USB001Z unit from the computer.

### 5.3. Windows 8

Two drivers can be removed using the *Device Manager*. Do not reverse following (3) (5) in the order by which the driver software are deleted.

**(1) Connect the USB001Z unit to the computer with a USB cable.**

\* At this time, do not connect the USB001Z unit to the inverter.

**(2) Open the Device Manager.**

Refer to section 3.4 (3).

**(3) Click the ">" sign on the left side of "Port (COM&LPT)".**

Select "USB001Z Serial Port", right-click on the mouse and select *Uninstall*.

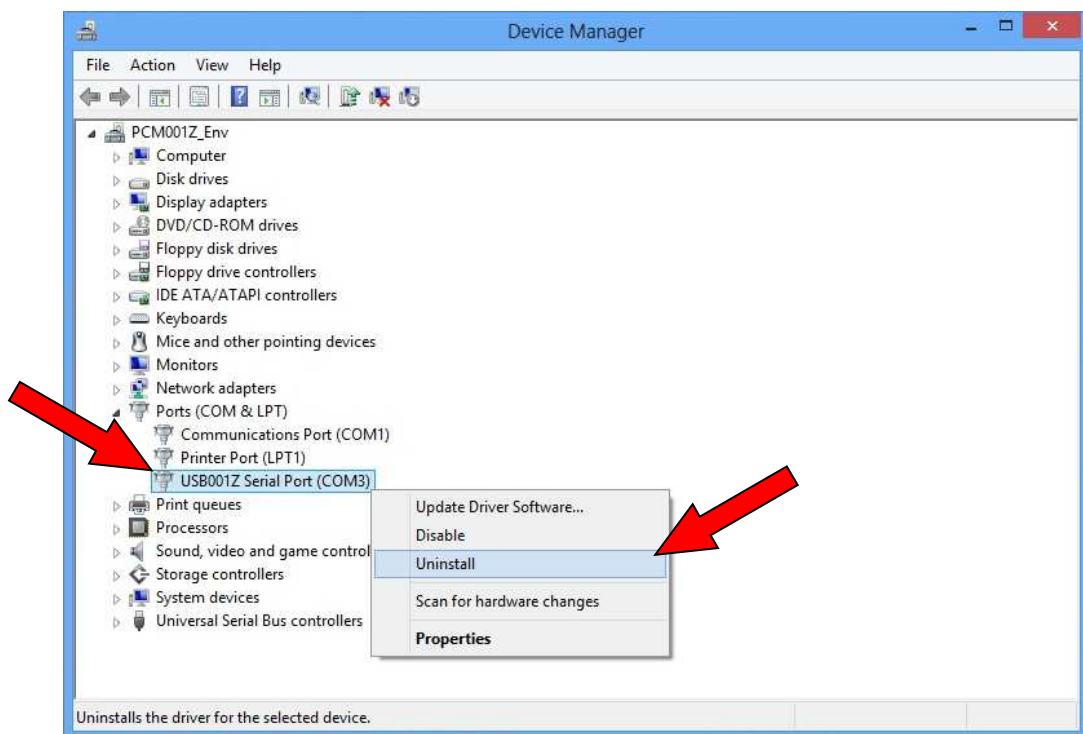

**(4) Click the checkbox for "Delete the driver software for this device" on the uninstall dialog box and then click [OK].**



(5) Click the ">" sign on the left side of "Universal Serial Bus Controllers".

Select "USB001Z Serial Converter USB001Z", right-click on the mouse and select Uninstall.

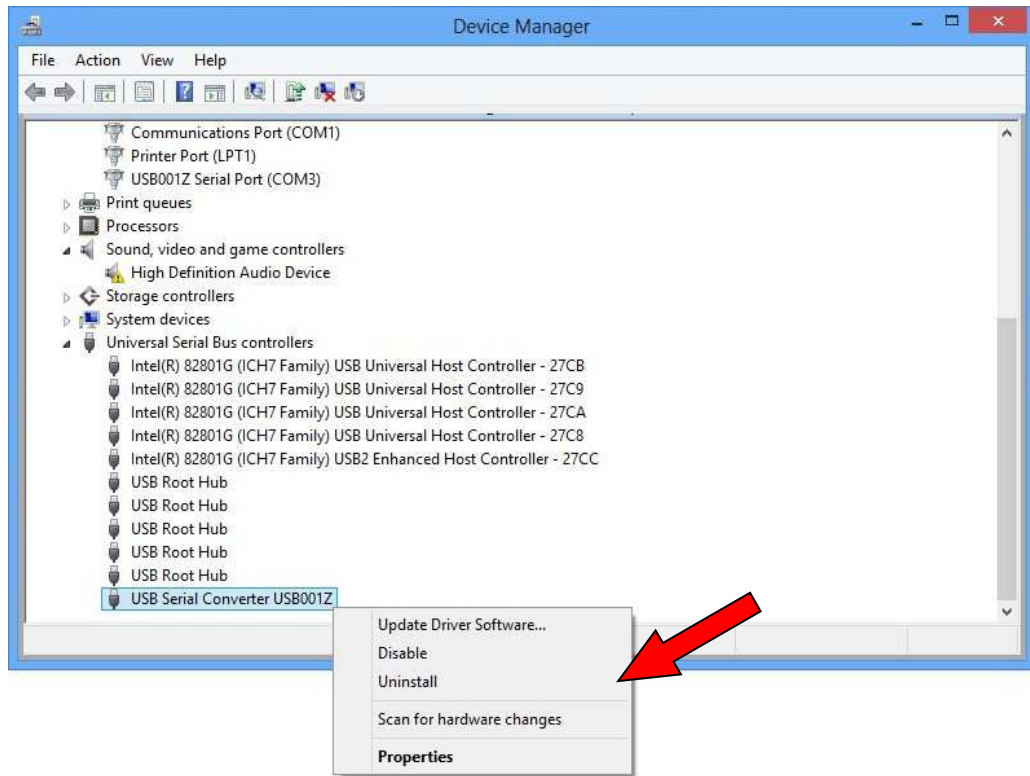

(6) Click the checkbox for "Delete the driver software for this device" on the uninstall dialog box and then click [OK].



(7) Disconnect the USB001Z unit from the computer.

## 5.4. Windows 10

Two drivers can be removed using the *Device Manager*. Do not reverse following (3) (5) in the order by which the driver software is deleted.

**(1) Connect the USB001Z unit to the computer with a USB cable.**

\* At this time, do not connect the USB001Z unit to the inverter.

**(2) Open the Device Manager.**

Refer to section 4.4 (1).

**(3) Click the ">" sign on the left side of "Port (COM&LPT)".**

Select "USB001Z Serial Port", right-click on the mouse and select *Uninstall device*.

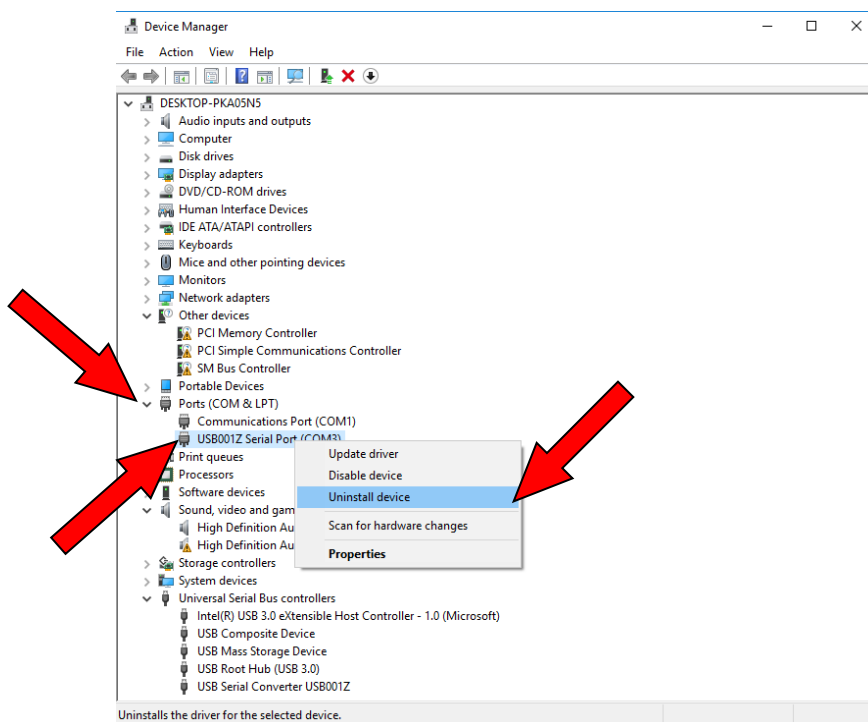

**(4) Click the checkbox for "Delete the driver software for this device" on the uninstall dialog box and then click [Uninstall].**

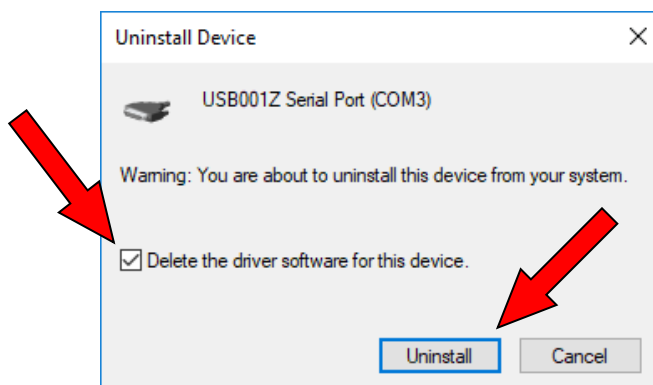



(5) Click the "▷" sign on the left side of "Universal Serial Bus Controllers".

Select "USB001Z Serial Converter USB001Z", right-click on the mouse and select *Uninstall device*.

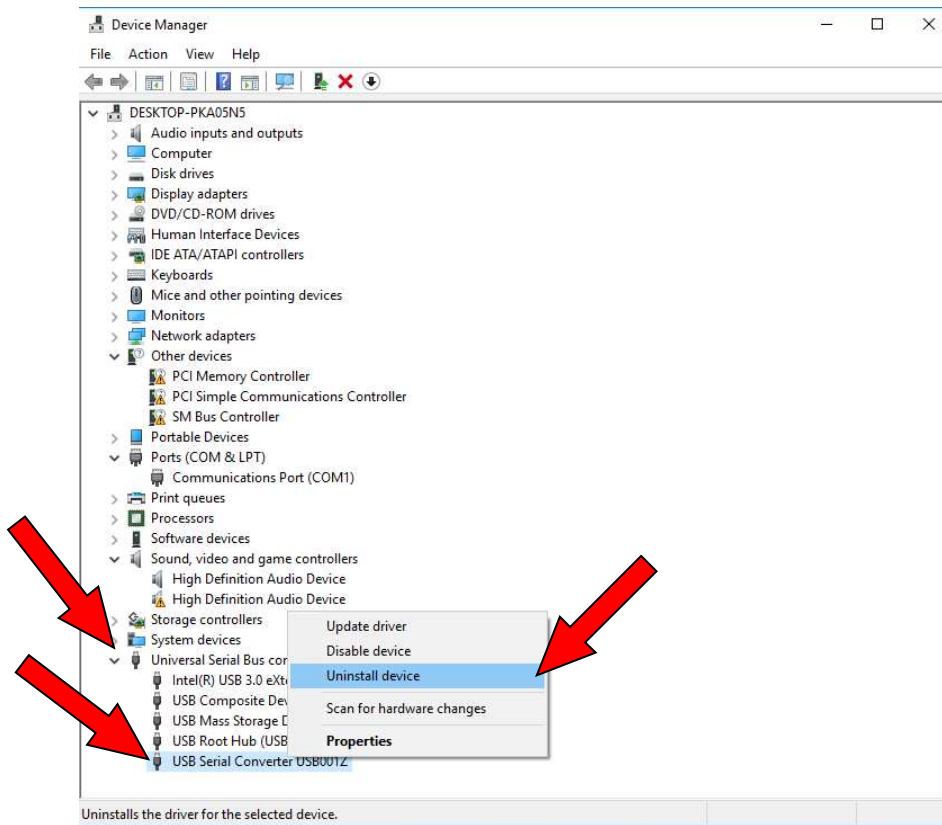

(6) Click the checkbox for "Delete the driver software for this device" on the uninstall dialog box and then click [Uninstall].

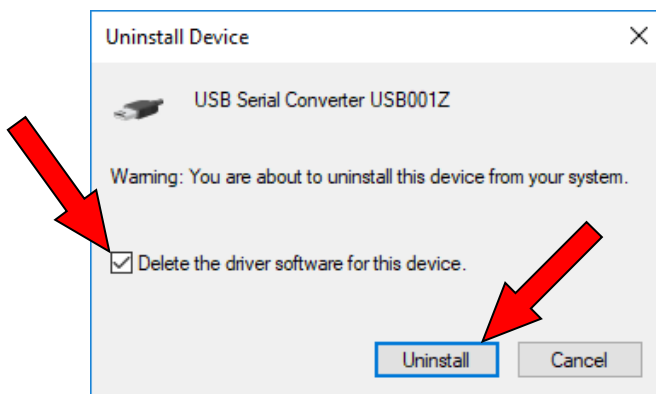

(7) Disconnect the USB001Z unit from the computer.

## 6. Connecting and starting the USB001Z unit

To connect the USB001Z unit to your computer, follow these steps:

- 1) Turn off the input power to the inverter, and after waiting for at least 15 minutes, make sure that the charge lamp on the inverter is no longer lit. (Your personal computer can remain powered on.)
- 2) Connect a USB cable to the USB port on the USB001Z unit and to a USB port on your computer.

When connecting the USB001Z unit to your computer for the first time, you have to install its driver. Refer to Chapter 3.

- 3) Connect an inverter-unit connection cable (optional) between the communication connector of the USB001Z and that of the inverter. Refer to the instruction manual of the inverter for connection to the connection port of the inverter, and choose either RS485 (2-wire type) side or LOGIC (common serial) side on the USB001Z. At this time, be careful not to apply force to the connectors.

RS 485 (2-wire type) side: Connectable to such an RS485 (2-wire type) interface port as that of the VF-nC3, S15, FS1, MB1, AS1, PS1, or AS3.  
 LOGIC side: Connectable to such a common serial interface port as that of the VF-nC1, S9, S11, A7, or P7.

\* Connect the cable only to either RS485 or LOGIC.

- 4) Turn on the power to the inverter, and set communication parameters.

\* Before disconnecting the USB communication unit, also perform above step 1) beforehand.

\* Avoid connecting the conversion unit to a USB hub or extended USB port (e.g., PCMCIA card). Or else the conversion unit may become unstable, depending on the environment in which it is used.

### CAUTION



Prohibited

- Do not disconnect the USB cable during communication with the inverter. Otherwise, damage or malfunction will result.

■ Example of connection (In the case of the VF-AS1)

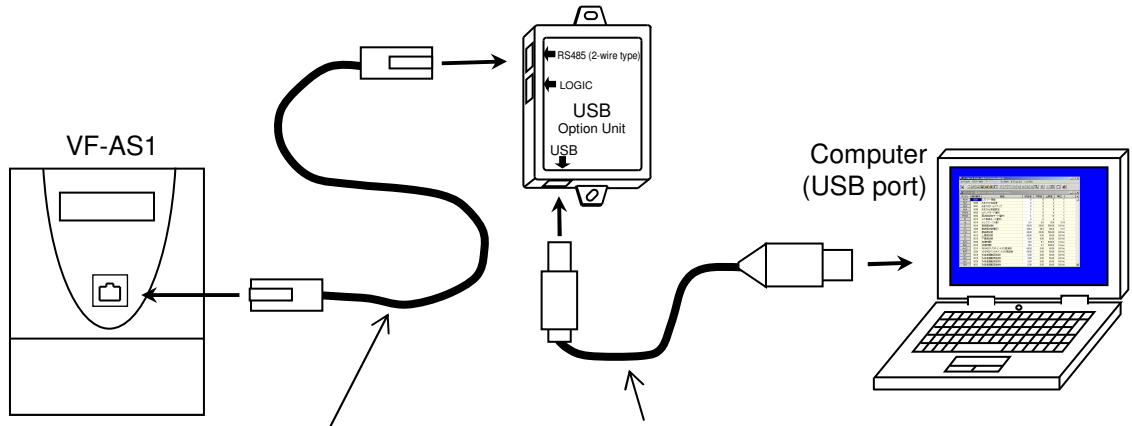

- Inverter-unit connection cable (Optional)

Model number	Cable length
CAB0011	1.2m
CAB0013	3.6m
CAB0015	4.8m

- USB cable (A-B connection type)  
 Use a commercially available USB cable.  
 (Compliant with USB 1.1/2.0)  
 Recommended cable length: 1m

# 7. Outline drawing

Here is an outline drawing of the USB001Z unit. (Unit: mm)

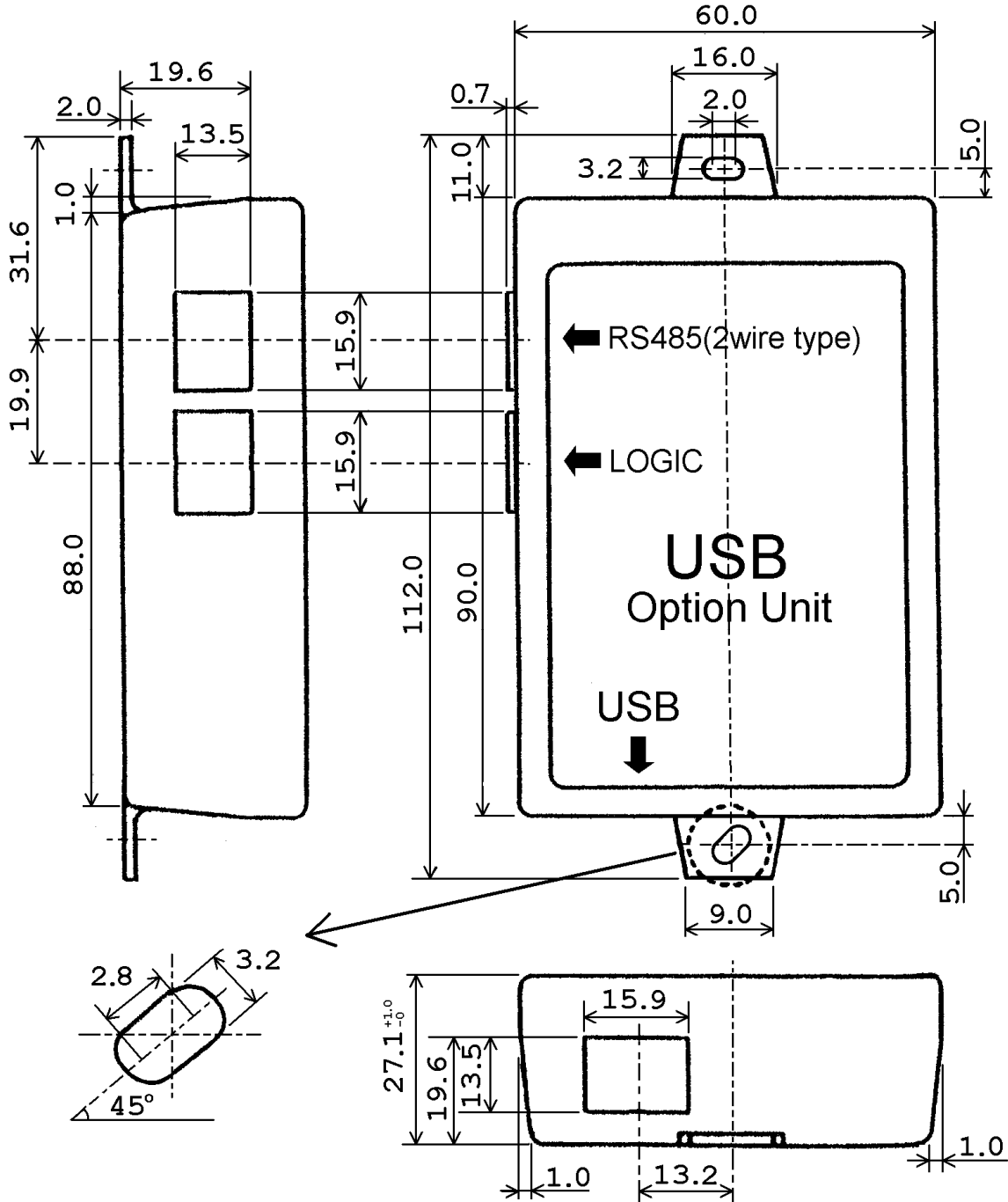

General tolerance : ±0.5

## 8. Specifications

Item	Specifications
Model number	USB001Z
Applicable model	Model with either an RS485 (2-wire type) connector or a common serial connector (optional). Usable applications: PCM001Z (V013 or successor), PCS001Z (V001 or successor), PCM002Z, and others (see instruction manuals of each tool)
Applicable OS <sup>*1</sup>	Windows XP SP3, Windows Vista SP1, SP2, Windows 7 (32bit, 64bit) , Windows 8 (32bit, 64bit) , Windows 10 (32bit, 64bit) <sup>*2</sup> However, the personal computer <sup>*3</sup> must have a USB port (series A).
Use environments	Indoor operation at an altitude of 1,000m or less and free from direct sunlight, potentially corrosive or explosive gases, steam, dust particles, dust/dirt, and machining fluids (grinding liquid, coolant, included)
Ambient temperature	0 to +50°C
Storage temperature	-25 to +65°C
Relative humidity	20 to 93% (free from condensation and vapor)
Vibration	5.9m/s <sup>2</sup> (0.6G) or less (10 to 55Hz) (Compliant with IEC 60068-2-6)
Cooling method	Self-cooling

\*1: Applicable OS in this document is subject to change without notice. Please confirm the latest applicable OS from your distributor.

\*2: Windows, Windows Vista are either registered trademarks or trademarks of Microsoft Corporation in the United States and/or other countries.

\*3: No warranty as to the suitability of this product for any computer and any peripheral equipment is either made or implied.

\*4: Do not connect two or more USB001Z to PC.

---

## 9. Warranty

---

### Warranty period

This product's warranty period is 12 months after the purchase, or 18 months from the date of manufacture printed on the rating plate, whichever precedes the other.

The warranty period of repaired products will not exceed the warranty period before the repair takes place.

### Scope of warranty

If a product failure is found during the warranty period due to our negligence, please return the product to Toshiba distributor of purchase, for a replacement or repair of the defective component.

The warranty shall only cover the purchased or delivered product itself.

The following circumstances will incur paid service even before the warranty period expires.

- Product replacement or repair when the product is not returned.
- Product failure or damage due to misuse, inappropriate repair or modification of the product.
- Product failure or damage for reasons such as but not limited to a fall after purchase, an accident during transport, or handling (e.g. smoking) during transport.
- Product failure or damage by natural disasters or unforeseeable external causes such as but not limited to fire, salt exposure, gas exposure, earthquakes, storms, floods, lightning and abnormal voltage.
- Product failure or damage by use under inappropriate circumstances, environments or use not suggested in the product catalog or instruction manual, or use not complying with the original use intended for the product.
- Product failure or damage by the lack of proper maintenance or replacement of expiring parts suggested in the instruction manual.
- In case the product is embedded in your equipment, product failure or damage by causes irrelevant to the product, such as the design of your equipment and software.
- In case the product is embedded in your equipment, product failure that could have been avoided if your equipment had featured a safety device in compliance with the law that governs your equipment, or any feature or structure that is considered the norm by the industry standard.
- Any product failure or damage by accidents that were unforeseeable with the technological standard at shipment.

### Warranty exemptions

Irrespective of the warranty period, the warranty shall not cover the following conditions.

- Compensation for any damage not attributed to our negligence.
- Compensation for any loss of business opportunity or income caused by failure of the product.
- All liabilities and compensations for any damage, secondary damage, accidents, damage to any entity that is not the product and damage to any other operations that arise from special circumstances, that we may or may not foresee.
- Any compensations for the results of your product replacement, readjustment of the local equipment after replacement, launch test, inspections, or any other operations.

### Service after the stop production

Please ask Toshiba distributor of purchase about the stop of production and repair work for each product.