

PROVEN PERFORMANCE

Customers in over 60 countries and in diverse markets and sectors.

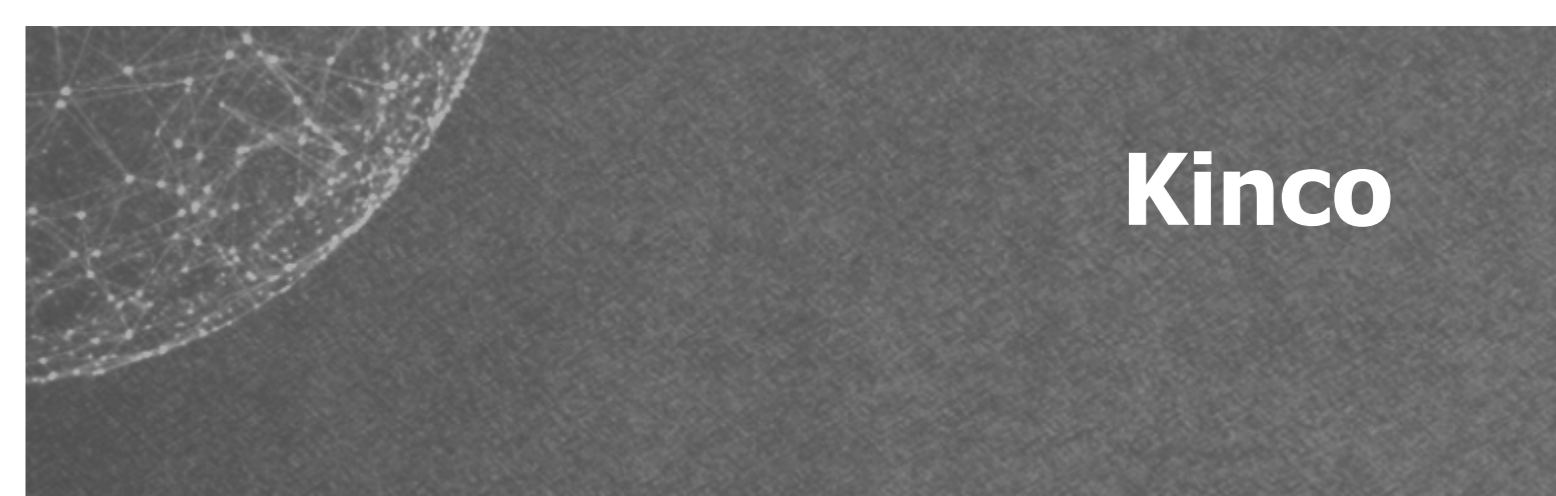

Motion
Control
Servo System

➔ **Servo System Catalog**

- FD5 Series Servo Drive
- Servo Motor



Kinco® Automation
www.kinco.cn Email: sales@kinco.cn

(All trademarks and logos in this brochure are property of and registered by their respective owners.)

K1E56-2211

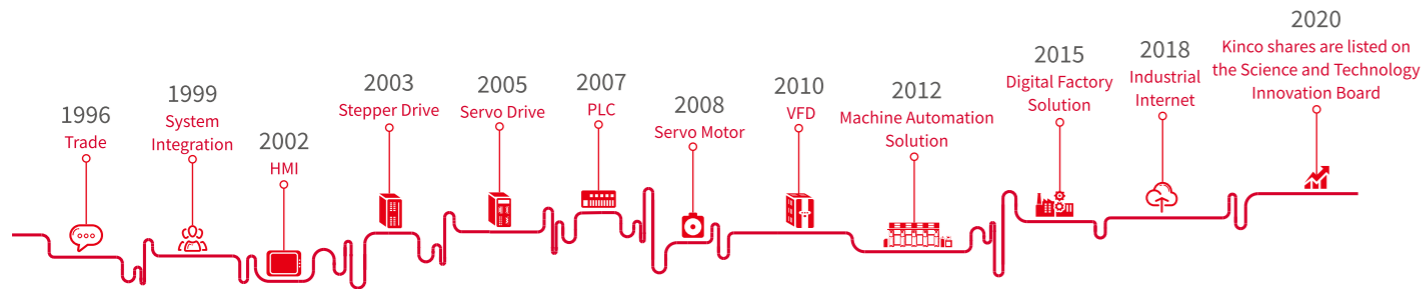

Shanghai Kinco Automation Co., Ltd. focuses on R&D, production, sales and technical services of automation standard products and intelligent hardware products, which is a leading supplier of machine automation and intelligent solutions for factories in China.

In 1996, Kinco has been providing total automation solutions for global industrial automation equipment manufacturers by relying on standard automation products such as HMI, servo system, stepping system, PLC, low-voltage inverter, etc. to penetrate into the industry, making China's automation solutions prevail all over the world. The company's HMI products have led the wave of HMI popularization in China, and its market share has maintained a leading position among local brand manufacturers for many years.

With the mission of "Making China's manufacturing become the top manufacturing in the world", Kinco company insists on investing a large amount of resources in the research and development of automated technology platforms, and sets up R&D facilities in Shanghai, Shenzhen and Changzhou. Kinco company has an automated technology platform that covers all aspects of control, drive, human-machine interaction, communication and electromechanical integration design. In the field of machine automation, Kinco focuses on the industry and has developed special solutions for logistics automation, service robots, medical instruments, professional drones, 3C machine tools, ozone and other industries.

In the field of smart factory, Kinco provides customers with the most easy-to-implement smart factory solutions for manufacturing companies at the field implementation level, PLC control and communication level, Scada and system integration level, and MES management level through its comprehensive automation technology platform and software system developed for smart factory.

With the vision of "creating a better life intelligently" and adhering to the values of "maintain conscience in growth and hold ingenuity in innovation", Kinco is a platform to help employees maximize their creative potential and a partner to help customers succeed in innovative management. We develop products and operate businesses with innovative thinking and practical spirit, adhere to ideals, and expect human creativity to make the world more wonderful.

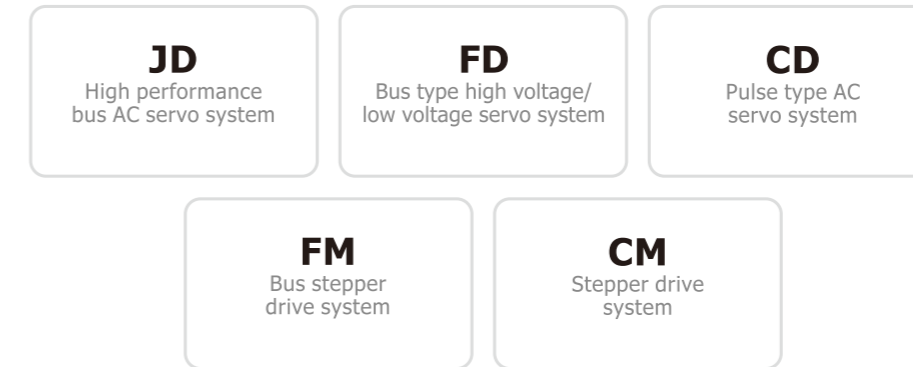

- Our design concept originated in Germany; support a variety of communication options such as pulse and Modbus/CANopen/EtherCAT/Profinet bus. It can drive all kinds of servo motors and stepper motors, including rotary servo motors, cable motors, direct drive motors, etc.
- It is widely used in the logistics AGV, 3C, medical, new energy, and machine registry industries.
- The product meets international quality and design standards, which is the first choice for international brand servo ODM.

- 02 SUMMARIZE
 - Drive characteristics
 - Naming rules for drives and motors/cables
 - Drive and motor configuration table
 - Drive/motor model table
- 08 DRIVE INTRODUCTION
 - Technical specifications
 - Drive and motor configuration table
 - Description of external wiring and communication terminals
 - Mechanical dimension
- 21 MOTOR INTRODUCTION
 - Motor characteristics
 - Technical specifications
 - Mechanical dimension
 - Torque-velocity curve
- 31 MOTOR CABLE CONNECTION TABLE
 - Encoder cable
 - Motor power cable
 - Brake cable

FD5 high performance AC servo

New support for Profinet bus communication



FD5 feature



- The power range covers 200W~3KW with compact structure design.
- Significantly improved control performance and response ability to provide customers with more solutions.
- Strong compatibility: 5 generations of products are compatible with 3 generations of product parameters, which can directly update the parameters to replace.

FD5 series servo drive with five advantages

Notch filter

For vibration suppression. Up to 4 notch filters can be used simultaneously. The mechanical resonance frequency of the load is automatically measured and the notch frequency is automatically set based on the measurement results.

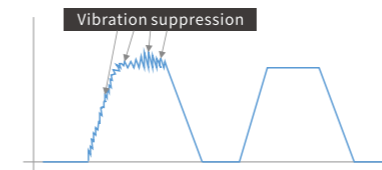

Suitable for high-precision encoder

Higher sampling frequency with high precision encoder helps to improve overall servo responsiveness and positioning accuracy.

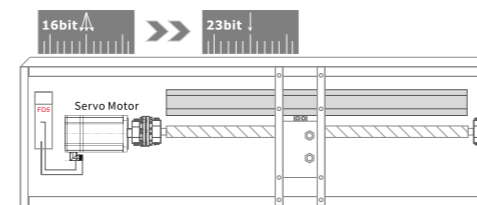

Real-time synchronization control

- Supports 125us synchronization cycles;
- EtherCAT communication rate can reach 100Mbit/S;
- Adopt distributed clock synchronization;
- It can effectively improve production efficiency and improve the accuracy of multi-axis synchronous control.

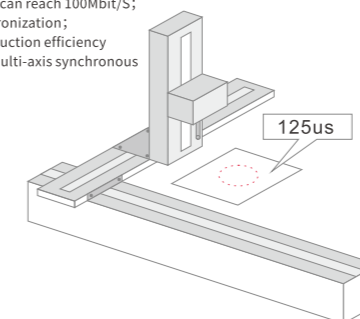

Easy tune optimized upgrade and online self-tuning

The self-tuning module calculates the load amount by changing the state of the load under acceleration and deceleration. By adding monitoring signals to the PWM for measurement during motor operation, the load inertia is obtained and then the PID controller is dynamically adjusted according to the set rigidity and application type.

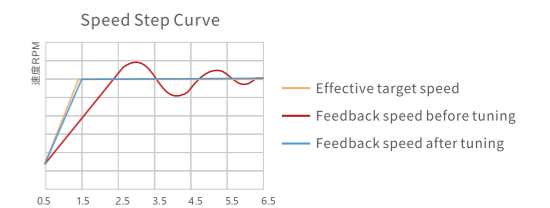

S-curve control

S-type curve control opens with one key; no command delay; suitable for long distance positioning control. The speed step of trapezoidal speed curve is large. For mechanical equipment with large inertia or flexible connection equipment, vibration may be caused by sudden change of trapezoidal speed. S-type speed curve is more flexible, smooth acceleration and deceleration, which can effectively overcome the mechanical vibration caused by sudden change of speed.



Support for multiple bus communication



Note: These trademarks are owned by their respective companies.

Drive and motor/cable naming rules

Drive: **FD425-PA-000**

① ② ③ ④ ⑤ ⑥



①-Series name	FD: FD series	④-Drive version	5: Fifth generation drive
②-Supply voltage	4: Input Voltage AC220V 6: Input Voltage AC380V	⑤-Controlled type	EA: RS232, EtherCAT, Pulse CA: RS232, CAN, Pulse LA: RS232, RS485, Pulse PA: RS232, Profinet
③-Drive current	1: AC220V 2A 2: AC220V 3.9A or AC380V 7A 3: AC220V 10A	⑥-Software version	000: Software version number

Motor: **SMC60S-0020-30MAK-5LSU**

① ② ③ ④ ⑤ ⑥ ⑦ ⑧ ⑨ ⑩ ⑪ ⑫



①-Series name	SMC: SMC series SMG: SMG series	⑦-Brake holder	A: Without brake B: With brake
②-Flange	60: 60x60(mm) 80: 80x80(mm) 130: 130x130(mm)	⑧-Output shaft style	A: Light shaft K: With key
③-Inertia type	S: Small inertia D: Medium inertia	⑨-Number of polar pairs	4: 4 polar pairs 5: 5 polar pairs
④-Rated power:	0020: 20x10(W) 0040: 10x40(W)	⑩-Supply voltage:	L: AC220V H: AC380V
⑤-Rated speed:	10: 10x100(rpm) 20: 20x100(rpm) 30: 30x100(rpm)	⑪-Motor version number	S: S version K: K version
⑥-Encoder type:	M: Singleturn communication type magnetoelectric encoder Q: Multiturn communication type magnetoelectric absolute value encoder V: Singleturn communication type optical encoder Y: Multiturn communication type optical absolute value encoder	⑫- Motor outlet type:	U: Communication encoder socket Q: AMP17 series sockets P: HFO21+HFO18 series general aviation socket Note: Kinetic aerial plug HFO21, encoder aerial plug HFO18

Drive and motor/cable naming rules

Power cable: **MOTF-005-LL-KL-NS**

① ② ③ ④ ⑤ ⑥

①-Cable function type	MOT: Motor power cable	④-Cable length	03:3m/05:5m/ 10:10m/15:15m/20:20m
②-Cable type	F: Flexible cable Empty: Common Cable	⑤-Motor outlet type	KL: 4PIN power plug KC4: HFO21 series of general aviation plug KQ: 4PIN AMP17 series power plug
③-Rated current	005: 5A 008: 8A 015: 15A	⑥-Cable note	NS: General Cable Empty: Highly shielded cable B: The power cable includes the holding brake cable(Suitable for KC4 aviation socket brake motor)

Encoder cable: **ENC DGF-LL-GU-BT5**

① ② ③ ④ ⑤ ⑥ ⑦ ⑧

①-Cable function type	ENC: Motor encoder cable	⑤-Cable length	03:3m/05:5m/ 10:10m 15:15m/20:20m
②-Drive encoder connector type	D: 1394 connector	⑥-Core cable type	G: 6 core cable
③-Drive connection definition	G: Communication type connector	⑦-Type of encoder connector to the motor end	U: Communication type encoder connector C0: HFO series of general aviation plugs Q: 9PIN AMP17 series encoder plugs
④-Cable type	F: Flexible cable Empty: Common Cable	⑧-Cable accessories	BT5: Encoder cable for battery connection Empty: No battery

Brake cable: **BRAF-LL-KL**

① ② ③ ④

①-Cable function type	BRA: Motor holding brake cable	③-Cable length	03:3m/05:5m/ 10:10m 15:15m/20:20m
②-Cable type	F: Flexible cable Empty: Common Cable	④-Connector type	KL: 2PIN brake plug KQ: 2PIN AMP17 series brake plug

Drive model list

Series	Specification model	Wattage (W)	Supply voltage	MAX continuous output current (rms) (A)	Peak current (A)	Control model	Weight (Kg)	Dimension L*W*H (mm)
FD5 series	FD425-LA-000	200/400	AC220V	3.9	18	RS485	0.881	160*153*40
	FD425-CA-000					CANopen		
	FD425-EA-000					EtherCAT		
	FD425-PA-000					Profinet		
	FD425-LF-000					RS485		
	FD425-CF-000	CANopen		1.5	160*153*55			
	FD425-EF-000	EtherCAT						
	FD425-PF-000	Profinet						
	FD435-LA-000	RS485						
	FD435-CA-000	CANopen						
	FD435-EA-000	EtherCAT		1.5	219*187*56			
	FD435-PA-000	Profinet						
	FD625-LA-000	RS485						
	FD625-CA-000	CANopen						
	FD625-EA-000	EtherCAT						
FD625-PA-000	Profinet							

Motor mode list

SMG series	Specification model	Rated wattage Pn(W)	Rated torque Tn(Nm)	Rated speed nN(rpm)	Rated current In(A)	Shaft diameter (mm)	Fuselage length (mm)	
							□=A	□=B (Brake motor)
60 Flange	SMG60S-0020-30M□K-5LSQ	200	0.64	3000	1.6	14	67.5±1.5	98±1.5
	SMG60S-0020-30Q□K-5LSQ							
	SMG60S-0040-30M□K-5LSQ	400	1.27		85.5±1.5		116±1.5	
	SMG60S-0040-30Q□K-5LSQ							
80 Flange	SMG80S-0075-30M□K-5LSQ	750	2.39	4.6	19	92.5±1.5	127±1.5	
	SMG80S-0075-30Q□K-5LSQ							

Note: □=A : Motor without brake
□=B : Motor with brake

SMC series	Specification model	Rated wattage Pn(W)	Rated torque Tn(Nm)	Rated speed nN(rpm)	Rated current In(A)	Shaft diameter (mm)	Fuselage length (mm)	
							□=A	□=B (Brake motor)
60 Flange	SMC60S-0020-30M□K-5LSU	200	0.64	3000	1.5	14	75±1.5	112.5±1.5
	SMC60S-0020-30Q□K-5LSU							
	SMC60S-0020-30□K-5LSU	400	1.27		86.5±1.5		122±1.5	
	SMC60S-0040-30M□K-5LSU							
	SMC60S-0040-30Q□K-5LSU	400	1.27		97±1.5		134.5±1.5	
SMC60S-0040-30□K-5LSU								
80 Flange	SMC80S-0075-30M□K-5LSU	750	2.39	4	19	106.7±1.5	141±1.5	
	SMC80S-0075-30Q□K-5LSU							
	SMC80S-0075-30□K-5LSU							
130 Flange	SMC130D-0100-20□K-5LSP	1KW	4.78	2000	4.5 (ref.)	22	143.5±1.5	203.5±1.5
	SMC130D-0100-10MAK-5LSP							
	SMC130D-0150-20□K-5LSP	1.5KW	7.16	2000	7.7 (ref.)		171±1.5	-
	SMC130D-0150-20□K-5LSP							
	SMC130D-0200-20□K-5LSP	2KW	9.55	2000	9.5 (ref.)		163.5±1.5	223.5±1.5
	SMC130D-0200-20□K-5LSP							
	SMC130D-0150-20□K-5HSP	1.5KW	7.16	1000	3.85 (ref.)		179.5±1.5	239.5±1.5
	SMC130D-0150-10MAK-5HSP							
	SMC130D-0200-20□K-5HSP	2KW	9.55	2000	4.75 (ref.)		163.5±1.5	223.5±1.5
SMC130D-0200-20□K-5HSP								
SMC130D-0300-20□K-5HSP	3KW	14.33	2000	7 (ref.)	179.5±1.5	239.5±1.5		
					213.5±1.5	273.5±1.5		

Note: □=V : Singleturn communication type optical encoder
Y : Multiturn communication type optical absolute value encoder
M : Singleturn communication type magnetoelectric encoder
Q : Multiturn communication type magnetoelectric absolute encoder

□=A : Motor without brake
□=B : Motor with brake

Technical specifications of FD5 servo drive



Model parameter		FD5 series			
		FD425-□A-000	FD425-□F-000	FD435-□A-000	FD625-□A-000
Power supply	Power supply	1PH 200-240VAC±10% 50/60Hz±3HZ		1PH,3PH, 200-240VAC±10% 50/60Hz±3HZ	3PH, 380-415VAC±10% 50/60Hz±3HZ
	Logic power supply	None			
Current	Maximum continuous output current (rms)	3.9A	5A	10A	7A
	Peak current (PEAK)	18Ap	18Ap	27.5Ap	25Ap
Feedback signal		Singleturn communication type magnetoelectric encoder;Optoelectronic singleturn encoder motor;Photoelectric multiturn absolute value encoder			
Energy consumption brake		Fd425 drive has no built-in braking resistor, FD435 has built-in 100Ω, limited power of 20W; FD625 built-in 300Ω, limited power 20W;The actual power exceeds the limit power and requires an external braking resistor (depending on the operating conditions, mainly used in the case of rapid start and stop).			
Energy consumption braking voltage absorption point		DC380V±5V		DC680V±5V	
Overvoltage alarm voltage		DC400V±5V		DC710V±5V	
Undervoltage alarm voltage		DC200V±5V		DC400V±5V	
Cooling method		Natural cooling	Forced air cooling	Forced air cooling	Forced air cooling
Weight (KG)		0.881		1.5	
Location control mode	Command control mode	External pulse input control;Control of 8-segment position using DIN signal;Communication setting internal object parameter control			
	Command smoothing mode	Low-pass filtering (set by internal parameters), S-curve smoothing filtering (set by internal parameters in 1 mode)			
	Pulse command mode	Pulse+direction, CCW+CW, A-phase+B-phase (3.0V~30V, max. 500KHz)			
	Maximum input pulse frequency	Differential transmission mode: up to 4MHZ, open collector transmission mode: 500KHz			
	Electronic gear ratios	Setting range Gear factor: ~32768~32767, Gear divider: 1~32767, 1/50≤ Gear factor/Gear divider ≤50			
	Torque limit	Internal parameter setting			
	Feedforward gain	0~100.0% (Internal parameter setting)			
Position loop sampling frequency		2KHz			
Speed control mode	Command control mode	8-segment speed control using DIN signals;Communication settings internal object parameter control			
	Command smoothing mode	Low-pass filtering (Internal parameter setting)			
	Speed limit	Internal parameter setting			
	Torque limit	Internal parameter setting			
	Speed loop sampling frequency	8KHz			
Torque control mode	Command control mode	Communication setting internal object parameter control			
	Command smoothing mode	Low-pass filtering (Internal parameter setting)			
	Speed limit	Internal parameter setting			
	Current loop sampling frequency	16KHz			
Digital input	Input specification	7 digital inputs, through the connection of COM1 terminal, it can be valid at high level (12.5~30V) or valid at low level (0~5V).			
	Input function	The following functions can be defined according to your needs: drive enable, drive error reset, drive working mode control, speed loop proportional control, positive limit, negative limit, origin signal, command reverse, internal speed segment control, internal position segment control, emergency stop, pause, start to find the origin, command activation, wheel ratio switching, gain switching, position table function, clear pulse function, etc			
Digital output	Output specification	5-channel digital output, maximum voltage DC30V, OUT1 and OUT2 differential output, maximum output current 100mA, OUT3~OUT5 single-ended output, maximum output current 20mA, control motor OUT2 brake output through relay.			
	Output function	The following functions can be defined according to your needs:drive ready, drive error, motor position arrives, motor zero speed, motor holding brake, motor speed arrives, index Z signal appears, speed reaches limit, torque reaches setting, motor lock Axis, motor limit, origin found, multi-segment position, etc.			
Encoder signal output function		Output 5V motor A, B, Z signals, frequency division output range 0 ~ 65536; used for multi-axis synchronization, maximum output frequency 5MHz			
Protection function		Over-voltage protection, under-voltage protection, motor overheating (I2T) protection, short-circuit protection, drive overheating protection, etc.			
Standard		CE, IEC61800-5-1			
RS232		RS232 (connection with PC: RS-232 serial port to Mini_USB)			
RS485		Maximum support 115.2KHz baud rate, can use Modbus RTU protocol to communicate with the controller			
CANopen		Maximum support 1MHz baud rate, can use CANopen protocol to communicate with the controller			
EtherCAT		Support CoE (CIA402 protocol) and CSP/CSV/PP/PV/PT/HM mode, communication rate 100M			
Profinet		Support message 1, message 3, message 111, process objects, acyclic data read/write, etc.			
Use environment	Operation temperature	0~40°C			
	Storage temperature	-10°C~70°C			
	Humidity (no condensation)	5~95%			
	Protection level	IP20			
	Installation site	Dust-free, dry, lockable (e.g. electrical cabinets)			
	Installation method	vertical installation			
	Installation altitude	The rated working altitude is below 1000m.When the working altitude is above 1000m, every 100 meters of ascent is required, and the maximum working altitude is 4000 meters above sea level			
Atmosphere pressure		86kpa~106kpa			

Note: □=L: RS232, RS485, Pulse □=C: RS232, CAN, Pulse
□=P: RS232, Profinet □=E: RS232, EtherCAT, Pulse

FD5 servo drive and motor configuration table (1)

Series	Rated power/Rated speed/ Rated torque	Servo motor	Description	Power cable Brake cable	Encoder cable	Servo drive				
						Profinet	Pulse EtherCAT	Pulse CANopen	Pulse Modbus 485	
SMC series	200W/3000rpm/0.64Nm	SMC60S-0020-30VAK-5LSU	Singleturn communication type optical encoder motor	MOT-005-LL-KL-NS	ENCDG-LL-GU	FD425-PA-000	FD425-EA-000	FD425-CA-000	FD425-LA-000	
		SMC60S-0020-30VBK-5LSU*	Singleturn communication type optical encoder brake motor	MOT-005-LL-KL-NS/BRA-LL-KL						
	400W/3000rpm/1.27Nm	SMC60S-0040-30VAK-5LSU	Singleturn communication type optical encoder motor	MOT-005-LL-KL-NS						
		SMC60S-0040-30VBK-5LSU*	Singleturn communication type optical encoder brake motor	MOT-005-LL-KL-NS/BRA-LL-KL						
	750W/3000rpm/2.39Nm	SMC80S-0075-30VAK-5LSU	Singleturn communication type optical encoder motor	MOT-005-LL-KL-NS	ENCDG-LL-GU ENCDG-(4)-GU-BT5 BAT-FD5	FD425-PA-000	FD425-EA-000	FD425-CA-000	FD425-LA-000	
		SMC80S-0075-30VBK-5LSU*	Singleturn communication type optical encoder brake motor	MOT-005-LL-KL-NS/BRA-LL-KL						
	200W/3000rpm/0.64Nm	SMC60S-0020-30YAK-5LSU	Multiturn communication type photoelectric absolute value encoder motor	MOT-005-LL-KL-NS	ENCDG-LL-GC0	FD425-PA-000	FD425-EA-000	FD425-CA-000	FD425-LA-000	
		SMC60S-0020-30YBK-5LSU*	Multiturn communication type photoelectric absolute value encoder brake motor	MOT-005-LL-KL-NS/BRA-LL-KL						
	400W/3000rpm/1.27Nm	SMC60S-0040-30YAK-5LSU	Multiturn communication type photoelectric absolute value encoder motor	MOT-005-LL-KL-NS						
		SMC60S-0040-30YBK-5LSU*	Multiturn communication type photoelectric absolute value encoder brake motor	MOT-005-LL-KL-NS/BRA-LL-KL						
	750W/3000rpm/2.39Nm	SMC80S-0075-30YAK-5LSU	Multiturn communication type photoelectric absolute value encoder motor	MOT-005-LL-KL-NS	ENCDG-LL-GC0	FD425-PA-000	FD425-EA-000	FD425-CA-000	FD425-LA-000	
		SMC80S-0075-30YBK-5LSU*	Multiturn communication type photoelectric absolute value encoder brake motor	MOT-005-LL-KL-NS/BRA-LL-KL						
	1kW/2000rpm/4.78Nm	SMC130D-0100-20VAK-5LSP	Multiturn communication type photoelectric absolute value encoder motor	MOT-005-LL-KC4		ENCDG-LL-GC0	FD425-PF-000	FD425-EF-000	FD425-CF-000	FD425-LF-000
		SMC130D-0100-20VBK-5LSP*	Multiturn communication type photoelectric absolute value encoder brake motor	MOT-005-LL-KC4-B						
	1.5kW/2000rpm/7.16Nm	SMC130D-0150-20VAK-5LSP	Singleturn communication type photoelectric encoder aviation socket motor	MOT-008-LL-KC4	ENCDG-LL-GC0		FD435-PA-000	FD435-EA-000	FD435-CA-000	FD435-LA-000
		SMC130D-0150-20VBK-5LSP*	Singleturn communication type photoelectric encoder aviation socket brake motor	MOT-008-LL-KC4-B						
	2kW/2000rpm/9.55Nm	SMC130D-0200-20VAK-5LSP	Singleturn communication type photoelectric encoder aviation socket motor	MOT-008-LL-KC4		ENCDG-LL-GC0	FD425-PF-000	FD425-EF-000	FD425-CF-000	FD425-LF-000
		SMC130D-0200-20VBK-5LSP*	Singleturn communication type photoelectric encoder aviation socket brake motor	MOT-008-LL-KC4-B						
	1.5kW/2000rpm/7.16Nm	SMC130D-0150-20VAK-5HSP	Singleturn communication type photoelectric encoder aviation socket motor	MOT-005-LL-KC4	ENCDG-LL-GC0 ENCDG-(4)-GU-BT5 BAT-FD5		FD625-PA-000	FD625-EA-000	FD625-CA-000	FD625-LA-000
		SMC130D-0150-20VBK-5HSP*	Singleturn communication type photoelectric encoder aviation socket brake motor	MOT-005-LL-KC4-B						
	2kW/2000rpm/9.55Nm	SMC130D-0200-20VAK-5HSP	Singleturn communication type photoelectric encoder aviation socket motor	MOT-005-LL-KC4		ENCDG-LL-GC0 ENCDG-(4)-GU-BT5 BAT-FD5	FD425-PF-000	FD425-EF-000	FD425-CF-000	FD425-LF-000
		SMC130D-0200-20VBK-5HSP*	Singleturn communication type photoelectric encoder aviation socket brake motor	MOT-005-LL-KC4-B						
	3kW/2000rpm/14.33Nm	SMC130D-0300-20VAK-5HSP	Singleturn communication type photoelectric encoder aviation socket motor	MOT-008-LL-KC4	ENCDG-LL-GC0 ENCDG-(4)-GU-BT5 BAT-FD5		FD435-PA-000	FD435-EA-000	FD435-CA-000	FD435-LA-000
		SMC130D-0300-20VBK-5HSP*	Singleturn communication type photoelectric encoder aviation socket brake motor	MOT-008-LL-KC4-B						
	1kW/2000rpm/4.78Nm	SMC130D-0100-20YAK-5LSP	Singleturn communication type photoelectric encoder aviation socket motor	MOT-005-LL-KC4		ENCDG-LL-GC0 ENCDG-(4)-GU-BT5 BAT-FD5	FD625-PA-000	FD625-EA-000	FD625-CA-000	FD625-LA-000
		SMC130D-0100-20YBK-5LSP*	Singleturn communication type photoelectric encoder aviation socket brake motor	MOT-005-LL-KC4-B						
	1.5kW/2000rpm/7.16Nm	SMC130D-0150-20YAK-5LSP	Multiturn communication type photoelectric absolute value encoder aviation socket motor	MOT-008-LL-KC4	ENCDG-LL-GC0 ENCDG-(4)-GU-BT5 BAT-FD5		FD425-PA-000	FD425-EA-000	FD425-CA-000	FD425-LA-000
		SMC130D-0150-20YBK-5LSP*	Multiturn communication type photoelectric absolute value encoder aviation socket brake motor	MOT-008-LL-KC4-B						
	2kW/2000rpm/9.55Nm	SMC130D-0200-20YAK-5LSP	Multiturn communication type photoelectric absolute value encoder aviation socket motor	MOT-008-LL-KC4		ENCDG-LL-GC0 ENCDG-(4)-GU-BT5 BAT-FD5	FD425-PF-000	FD425-EF-000	FD425-CF-000	FD425-LF-000
		SMC130D-0200-20YBK-5LSP*	Multiturn communication type photoelectric absolute value encoder aviation socket brake motor	MOT-008-LL-KC4-B						
	1.5kW/2000rpm/7.16Nm	SMC130D-0150-20YAK-5HSP	Multiturn communication type photoelectric absolute value encoder aviation socket motor	MOT-005-LL-KC4	ENCDG-LL-GC0 ENCDG-(4)-GU-BT5 BAT-FD5		FD435-PA-000	FD435-EA-000	FD435-CA-000	FD435-LA-000
		SMC130D-0150-20YBK-5HSP*	Multiturn communication type photoelectric absolute value encoder aviation socket brake motor	MOT-005-LL-KC4-B						
	2kW/2000rpm/9.55Nm	SMC130D-0200-20YAK-5HSP	Multiturn communication type photoelectric absolute value encoder aviation socket motor	MOT-005-LL-KC4		ENCDG-LL-GC0 ENCDG-(4)-GU-BT5 BAT-FD5	FD625-PA-000	FD625-EA-000	FD625-CA-000	FD625-LA-000
		SMC130D-0200-20YBK-5HSP*	Multiturn communication type photoelectric absolute value encoder aviation socket brake motor	MOT-005-LL-KC4-B						
	3kW/2000rpm/14.33Nm	SMC130D-0300-20YAK-5HSP	Multiturn communication type photoelectric absolute value encoder aviation socket motor	MOT-008-LL-KC4	ENCDG-LL-GC0 ENCDG-(4)-GU-BT5 BAT-FD5		FD625-PA-000	FD625-EA-000	FD625-CA-000	FD625-LA-000
		SMC130D-0300-20YBK-5HSP*	Multiturn communication type photoelectric absolute value encoder aviation socket brake motor	MOT-008-LL-KC4-B						
	200W/3000rpm/0.64Nm	SMC60S-0020-30MAK-5LSU	Multiturn communication type photoelectric absolute value encoder aviation socket motor	MOT-005-LL-KL-NS		ENCDG-LL-GU	FD425-PA-000	FD425-EA-000	FD425-CA-000	FD425-LA-000
		SMC60S-0020-30MBK-5LSU*	Multiturn communication type photoelectric absolute value encoder aviation socket brake motor	MOT-005-LL-KL-NS/BRA-LL-KL						
	400W/3000rpm/1.27Nm	SMC60S-0040-30MAK-5LSU	Singleturn communication type magnetoelectric encoder motor	MOT-005-LL-KL-NS	ENCDG-LL-GU		FD425-PF-000	FD425-EF-000	FD425-CF-000	FD425-LF-000
		SMC60S-0040-30MBK-5LSU*	Singleturn communication type magnetoelectric encoder brake motor	MOT-005-LL-KL-NS/BRA-LL-KL						
750W/3000rpm/2.39Nm	SMC80S-0075-30MAK-5LSU	Singleturn communication type magnetoelectric encoder motor	MOT-005-LL-KL-NS	ENCDG-LL-GU ENCDG-(4)-GU-BT5 BAT-FD5		FD425-PA-000	FD425-EA-000	FD425-CA-000	FD425-LA-000	
	SMC80S-0075-30MBK-5LSU*	Singleturn communication type magnetoelectric encoder brake motor	MOT-005-LL-KL-NS/BRA-LL-KL							
200W/3000rpm/0.64Nm	SMC60S-0020-30QAK-5LSU	Singleturn communication type magnetoelectric encoder motor	MOT-005-LL-KL-NS		ENCDG-LL-GU ENCDG-(4)-GU-BT5 BAT-FD5	FD425-PA-000	FD425-EA-000	FD425-CA-000	FD425-LA-000	
	SMC60S-0020-30QBK-5LSU*	Singleturn communication type magnetoelectric encoder brake motor	MOT-005-LL-KL-NS/BRA-LL-KL							
400W/3000rpm/1.27Nm	SMC60S-0040-30QAK-5LSU	Multiturn communication type magnetoelectric absolute value encoder motor	MOT-005-LL-KL-NS	ENCDG-LL-GU ENCDG-(4)-GU-BT5 BAT-FD5		FD425-PF-000	FD425-EF-000	D425-CF-000	FD425-LF-000	
	SMC60S-0040-30QBK-5LSU*	Multiturn communication type magnetoelectric absolute value encoder holding motor	MOT-005-LL-KL-NS/BRA-LL-KL							
750W/3000rpm/2.39Nm	SMC80S-0075-30QAK-5LSU	Multiturn communication type magnetoelectric absolute value encoder motor	MOT-005-LL-KL-NS		ENCDG-LL-GU ENCDG-(4)-GU-BT5 BAT-FD5	FD425-PA-000	FD425-EA-000	D425-CF-000	FD425-LF-000	
	SMC80S-0075-30QBK-5LSU*	Multiturn communication type magnetoelectric absolute value encoder holding motor	MOT-005-LL-KL-NS/BRA-LL-KL							

Note: 1. When the drive drives the brake device, an external DC24V/2A relay is required;
2. ENCDG-(4)-GU-BT5 and BAT-FD5 can be replaced by ENCDG-(4)-GU-BT (battery-powered cable for multi-turn communication absolute encoder motor, cable length 40CM).

FD5 servo drive and motor configuration table (2)

Series	Rated power/Rated speed/ Rated torque	Servo motor	Description	Power cable Brake cable	Encoder cable	Servo drive			
						Profinet	Pulse EtherCAT	Pulse CANopen	Pulse Modbus 485
SMC series	1KW/1000rpm/9.55Nm	SMC130D-0100-10MAK-5LSP	Singleturn communication type magnetolectric encoder aviation socket motor	MOT-005-LL-KC4	ENCDG-LL-GC0	FD425-PF-000	FD425-EF-000	FD425-CF-000	FD425-LF-000
	1KW/2000rpm/4.78Nm	SMC130D-0100-20MAK-5LSP	Singleturn communication type magnetolectric encoder aviation socket motor	MOT-005-LL-KC4					
		SMC130D-0100-20MBK-5LSP*	Singleturn communication type magnetolectric encoder aviation socket holding brake motor	MOT-005-LL-KC4-B					
	1.5KW/2000rpm/7.16Nm	SMC130D-0150-20MAK-5LSP	Singleturn communication type magnetolectric encoder aviation socket moto	MOT-008-LL-KC4					
		SMC130D-0150-20MBK-5LSP*	Singleturn communication type magnetolectric encoder aviation socket holding brake motor	MOT-008-LL-KC4-B					
	2KW/2000rpm/9.55Nm	SMC130D-0200-20MAK-5LSP	Singleturn communication type magnetolectric encoder aviation socket motor	MOT-008-LL-KC4					
		SMC130D-0200-20MBK-5LSP*	Singleturn communication type magnetolectric encoder aviation socket holding brake motor	MOT-008-LL-KC4-B					
	1.5KW/1000rpm/14.33Nm	SMC130D-0150-10MAK-5HSP	Singleturn communication type magnetolectric encoder aviation socket motor	MOT-005-LL-KC4					
	1.5KW/2000rpm/7.16Nm	SMC130D-0150-20MAK-5HSP	Singleturn communication type magnetolectric encoder aviation socket motor	MOT-005-LL-KC4					
		SMC130D-0150-20MBK-5HSP*	Singleturn communication type magnetolectric encoder aviation socket holding brake motor	MOT-005-LL-KC4-B					
	2KW/2000rpm/9.55Nm	SMC130D-0200-20MAK-5HSP	Singleturn communication type magnetolectric encoder aviation socket motor	MOT-005-LL-KC4					
		SMC130D-0200-20MBK-5HSP*	Singleturn communication type magnetolectric encoder aviation socket holding brake motor	MOT-005-LL-KC4-B					
	3KW/2000rpm/14.33Nm	SMC130D-0300-20MAK-5HSP	Singleturn communication type magnetolectric encoder aviation socket motor	MOT-008-LL-KC4					
		SMC130D-0300-20MBK-5HSP*	Singleturn communication type magnetolectric encoder aviation socket holding brake motor	MOT-008-LL-KC4-B					
	1KW/2000rpm/4.78Nm	SMC130D-0100-20QAK-5LSP	Multiturn communication type magnetolectric absolute value encoder aviation socket motor	MOT-005-LL-KC4	ENCDG-LL-GC0 ENCDG-(4)-GU-BT5 BAT-FD5	FD425-PF-000	FD425-EF-000	FD425-CF-000	FD425-LF-000
		SMC130D-0100-20QBK-5LSP*	Multiturn communication type magnetolectric absolute value encoder aviation socket brake motor	MOT-005-LL-KC4-B					
	1.5KW/2000rpm/7.16Nm	SMC130D-0150-20QAK-5LSP	Multiturn communication type magnetolectric absolute value encoder aviation socket motor	MOT-008-LL-KC4					
		SMC130D-0150-20QBK-5LSP*	Multiturn communication type magnetolectric absolute value encoder aviation socket brake motor	MOT-008-LL-KC4-B					
	2KW/2000rpm/9.55Nm	SMC130D-0200-20QAK-5LSP	Multiturn communication type magnetolectric absolute value encoder aviation socket motor	MOT-008-LL-KC4					
		SMC130D-0200-20QBK-5LSP*	Multiturn communication type magnetolectric absolute value encoder aviation socket brake motor	MOT-008-LL-KC4-B					
1.5KW/2000rpm/7.16Nm	SMC130D-0150-20QAK-5HSP	Multiturn communication type magnetolectric absolute value encoder aviation socket motor	MOT-005-LL-KC4						
	SMC130D-0150-20QBK-5HSP*	Multiturn communication type magnetolectric absolute value encoder aviation socket brake motor	MOT-005-LL-KC4-B						
2KW/2000rpm/9.55Nm	SMC130D-0200-20QAK-5HSP	Multiturn communication type magnetolectric absolute value encoder aviation socket motor	MOT-005-LL-KC4						
	SMC130D-0200-20QBK-5HSP*	Multiturn communication type magnetolectric absolute value encoder aviation socket brake motor	MOT-005-LL-KC4-B						
3KW/2000rpm/14.33Nm	SMC130D-0300-20QAK-5HSP	Multiturn communication type magnetolectric absolute value encoder aviation socket motor	MOT-008-LL-KC4						
	SMC130D-0300-20QBK-5HSP*	Multiturn communication type magnetolectric absolute value encoder aviation socket brake motor	MOT-008-LL-KC4-B						
SMG series	200W/3000rpm/0.64Nm	SMG60S-0020-30MAK-5LSQ	Singleturn communication type magnetolectric encoder motor	MOT-005-LL-KQ-NS	ENCDG-LL-GQ	FD425-PA-000	FD425-EA-000	FD425-CA-000	FD425-LA-000
		SMG60S-0020-30MBK-5LSQ*	Singleturn communication type magnetolectric encoder brake motor	MOT-005-LL-KQ-NS/BRA-LL-KQ					
	400W/3000rpm/1.27Nm	SMG60S-0040-30MAK-5LSQ	Singleturn communication type magnetolectric encoder motor	MOT-005-LL-KQ-NS					
		SMG60S-0040-30MBK-5LSQ*	Singleturn communication type magnetolectric encoder brake motor	MOT-005-LL-KQ-NS/BRA-LL-KQ					
	750W/3000rpm/2.39Nm	SMG80S-0075-30MAK-5LSQ	Singleturn communication type magnetolectric encoder motor	MOT-005-LL-KQ-NS					
		SMG80S-0075-30MBK-5LSQ*	Singleturn communication type magnetolectric encoder brake motor	MOT-005-LL-KQ-NS/BRA-LL-KQ					
	200W/3000rpm/0.64Nm	SMG60S-0020-30QAK-5LSQ	Multiturn communication type magnetolectric absolute value encoder motor	MOT-005-LL-KQ-NS	ENCDG-LL-GQ ENCDG-(4)-GU-BT5 BAT-FD5	FD425-PA-000	FD425-EA-000	FD425-CA-000	FD425-LA-000
		SMG60S-0020-30QBK-5LSQ*	Multiturn communication type magnetolectric absolute value encoder holding motor	MOT-005-LL-KQ-NS/BRA-LL-KQ					
	400W/3000rpm/1.27Nm	SMG60S-0040-30QAK-5LSQ	Multiturn communication type magnetolectric absolute value encoder motor	MOT-005-LL-KQ-NS					
		SMG60S-0040-30QBK-5LSQ*	Multiturn communication type magnetolectric absolute value encoder holding motor	MOT-005-LL-KQ-NS/BRA-LL-KQ					
750W/3000rpm/2.39Nm	SMG80S-0075-30QAK-5LSQ	Multiturn communication type magnetolectric absolute value encoder motor	MOT-005-LL-KQ-NS						
	SMG80S-0075-30QBK-5LSQ*	Multiturn communication type magnetolectric absolute value encoder holding motor	MOT-005-LL-KQ-NS/BRA-LL-KQ						

Note: 1. When the drive drives the brake device, an external DC24V/2A relay is required;
2. ENCDG-(4)-GU-BT5 and BAT-FD5 can be replaced by ENCDG-(4)-GU-BT (battery-powered cable for multi-turn communication absolute encoder motor, cable length 40CM).

Drive external wiring diagram

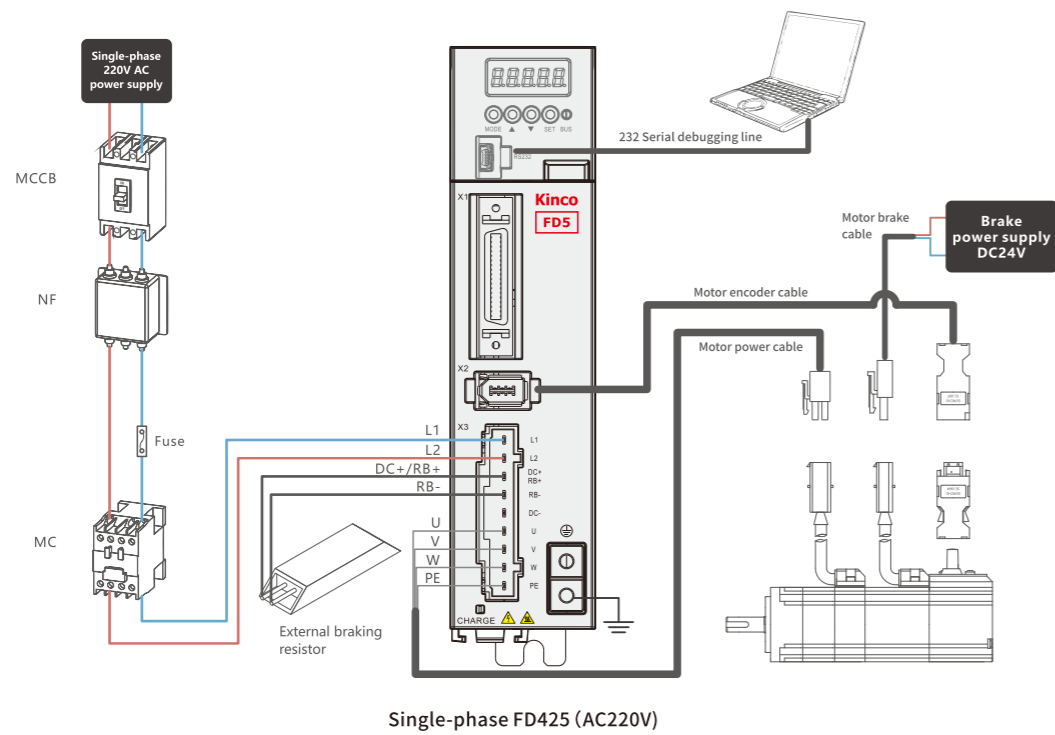

Drive external wiring diagram

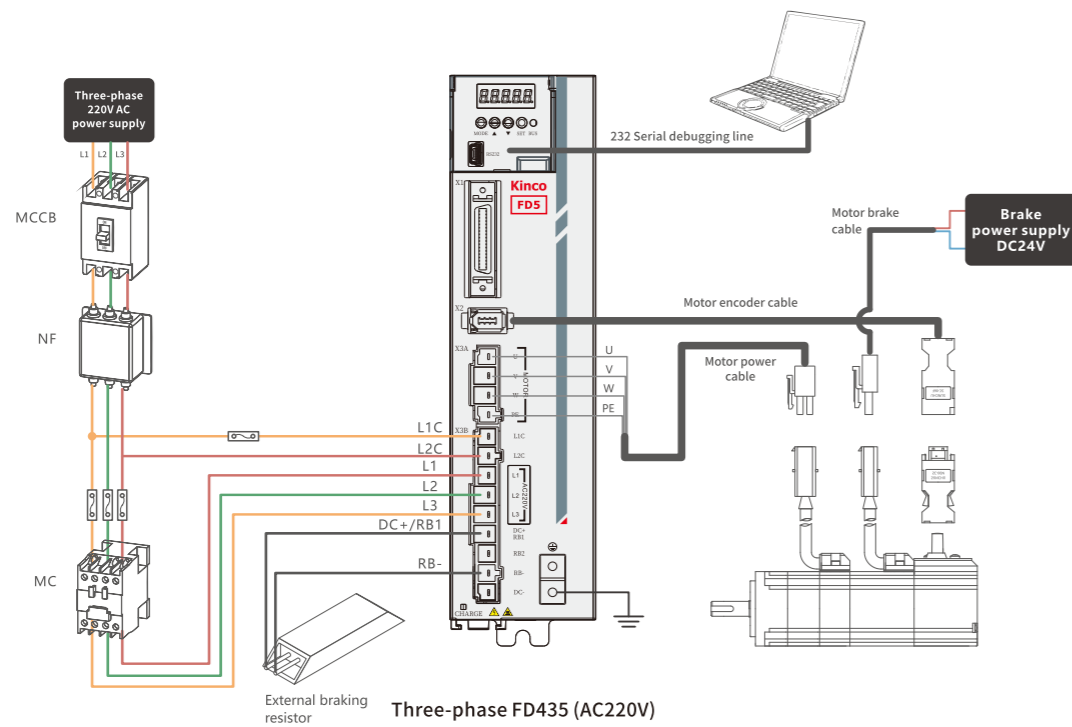
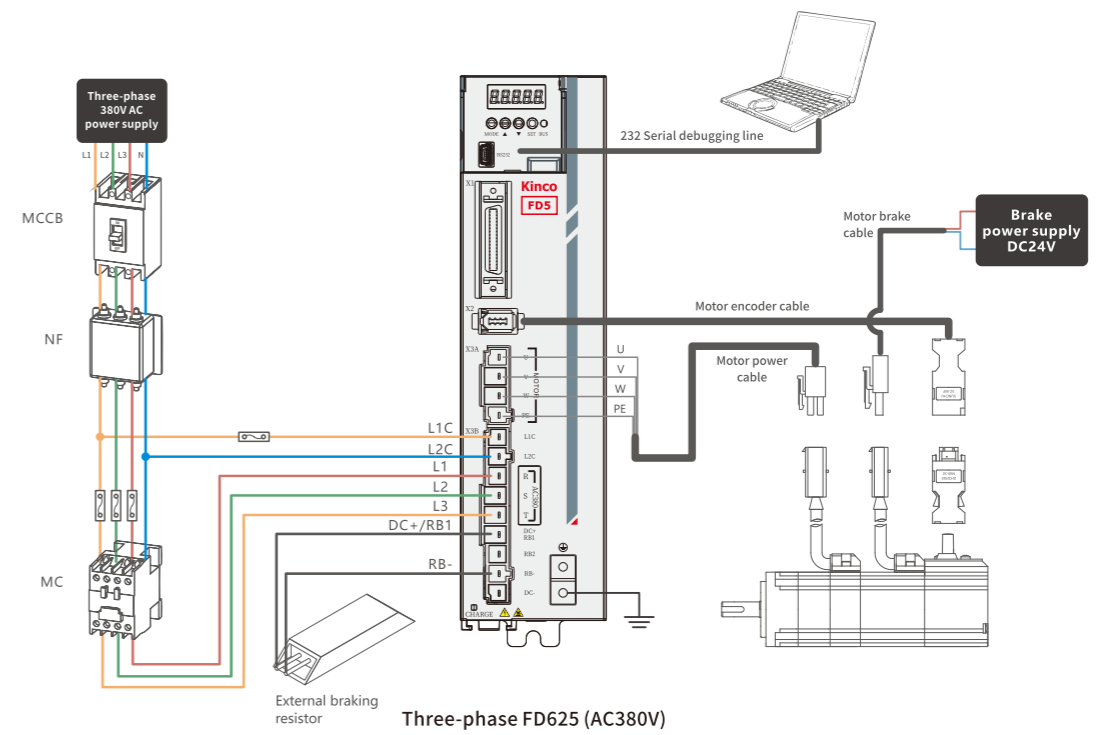

Note: When using the internal braking resistor, please short DC+/RB1 to RB2 (internal braking resistance value: FD435 built-in 100Ω/20W; FD625 built-in 300Ω/20W; When the braking power exceeds the tolerable range of the internal braking resistance, the drive will be alarmed for abnormal braking resistor and "0100" will be displayed. When the actual braking power demand exceeds the limit power, please choose the external braking resistor to be connected between DC+/RB1 and RB-, and be sure to disconnect the DC+/RB1 and RB2 short cables. Please refer to the user manual for the selection of external braking resistors.

Note: When using the internal braking resistor, please short DC+/RB1 to RB2 (internal braking resistance value: FD435 built-in 100Ω/20W; FD625 built-in 300Ω/20W; When the braking power exceeds the tolerable range of the internal braking resistance, the drive will be alarmed for abnormal braking resistor and "0100" will be displayed. When the actual braking power demand exceeds the limit power, please choose the external braking resistor to be connected between DC+/RB1 and RB-, and be sure to disconnect the DC+/RB1 and RB2 short cables. Please refer to the user manual for the selection of external braking resistors.

Communication port description of the drive

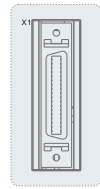

Interface number	Interface name	Interface type	Pin number	Signal marking	Signal name	Specification description
X1	I/O Interface	SCSI-36P-F	1	OUT1+	Digital output port 1 positive	Open collector output, maximum voltage DC30V, maximum current 100mA
			3	OUT1-	Digital output port 1 negative	
			5	OUT2+	Digital output port 2 positive	
			7	OUT2-	Digital output port 2 negative	
			9	OUT3	Digital output port 3	
			11	OUT4	Digital output port 4	The maximum voltage is DC30V, and the maximum current is 30mA
			20	OUT5	Digital output port 5	
			13	COMO	Digital output port 3, 4, 5 common site	
			15	VDD	External output power supply positive	Internal 24V power output, voltage range +/-20%, maximum current DC200mA
			17	VEE	External output power supply negative	
			2	COMI	Digital input common	The common positive terminal of the digital input port can be connected to the power supply range of 18-30VDC
			4	DIN1	Digital input port 1	When the COMI-DINx signal difference is greater than 12.5V, the signal is valid, and if it is less than 5V, the signal is invalid. It can receive relay output signal or NPN signal, and the maximum input frequency: 1KHz
			6	DIN2	Digital input port 2	
			8	DIN3	Digital input port 3	
			10	DIN4	Digital input port 4	
			12	DIN5	Digital input port 5	
			14	DIN6	Digital input port 6	
			16	DIN7	Digital input port 7	
			19	MA/	TTL signal: MA+,MA-MB+,MB-,MZ+,MZ-, Support the highest frequency 500KHz, voltage range DC3.3-30V Differential signal: MA,MA,MB,MB,MZ,MZ, Support maximum frequency 4MHz, voltage range DC 3.3-5V	MA, MB, MZ, MA/, MB/, MZ/ support 5V RS422 differential signal input, maximum pulse frequency 4MHz, optional signal type: ① Pulse+Direction (PLS+DIR) ② Forward and reverse pulses (CW/CCW) ③ A+B phase
			21	MB/		
			23	MZ/		
			25	NC		
			27	MA+ / MA		
			29	MA-		
			31	MB+ / MB		
			33	MB-		
			35	MZ+ / MZ		
			18	MZ-		
			22	+5V	Internal 5V power output	
			24	GND		
			26	ENCO_N	Encoder signal output	Output 5V motor A, B, Z signals, frequency division output range 0-65536; For multi-axis synchronization, the maximum output frequency is 5MHz
			28	ENCO_/N		
			30	ENCO_B		
			32	ENCO_/B		
			34	ENCO_A		
			36	ENCO_/A		

Note: FDXX5-PA-000 supports 5 channels of input and 3 channels of output (ie: DIN5, DIN6, OUT4, OUT5 are empty)

Suitable for FD425 drive

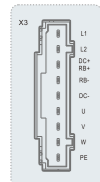

Interface number	Interface name	Interface type	Pin number	Signal marking	Signal name	Specification description
X3	Power terminals	9P/5mm Plug-in terminals	1	L1	Power supply input	1PH 200-240VAC 50/60Hz
			2	L2		
			3	DC+/RB1	DC bus,Braking resistance interface	1. The factory default does not connect the internal brake resistance. When braking exceeds the power drive, the brake resistance overpower alarm will be reported, and 0100 will be displayed. 2. When the motor needs an external braking resistor, connect it between DC+/RB+ and RB- 3. DC+/RB+, DC- are the positive and negative terminals of the DC bus
			4	RB-		
			5	DC-		
			6	U	Motor cable interface	Connect to motor cable U, V, W, PE
			7	V		
			8	W		
			9	PE		

Suitable for FD435, FD625 drive

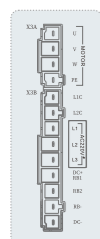

Note: *FD435: AC230V
*FD625: AC380V

Interface number	Interface name	Interface type	Pin number	Signal marking	Signal Name	Specification description
X3A	Power terminals	DEGSON 9EDGRC -7.5-04P-13-1000A(H)	1	U	Motor cable interface	Connect the motor cable U,V,W,PE
			2	V		
			3	W		
			4	PE		
X3B	Power terminals	DEGSON 9EDGRC -7.5-09P-13-1000A(H)	1	L1C	Logic power supply input	1PH 200-240VAC ±10% 50/60Hz ±3Hz
			2	L2C		
			3	L1	Power supply input	1PH,3PH, 200-240VAC 50/60Hz (FD435 14A) 3PH, 380-415VAC ±10% 50/60Hz ±3Hz (FD625 12A)
			4	L2		
			5	L3		
			6	DC+/RB1	DC bus braking resistor interface	DC+/RB1, DC- are the positive and negative terminals of the DC bus
			7	RB2		
			8	RB-		
			9	DC-		

Note: When using the internal braking resistor, please short DC+/RB1 to RB2 (internal braking resistance value: FD435 built-in 100Ω/20W; FD625 built-in 300Ω/20W; When the braking power exceeds the tolerable range of the internal braking resistance, the braking resistance of the alarm drive is abnormal and "0100" is displayed. When the actual braking power demand exceeds the limit power, choose to use an external braking resistor, connect between DC+/RB1 and RB-, and be sure to disconnect the short wiring between DC+/RB1 and RB2. Please refer to the user manual for the selection of external braking resistors.

Drive communication interface description



Interface number	Interface name	Interface type	Pin number	Signal marking	Signal name	Specification description
RS232	RS232 communication interface	Mini_USB 5pin terminal	1	NC		It can be connected to the host computer software of the PC side to set parameters and monitor the status
			2	RX	Drive data reception	
			3	TX	Drive data sending	
			4	NC		
			5	GND	Signal site	

Note: Customers can choose the stepco servo debugging cable-MINIUSB, model PDC-USBM-1 (5)



Interface number	Interface name	Interface type	Pin number	Signal marking	Signal name	Specification description
X2	Motor encoder interface F	1394 Master saet	1	+5V	5V positive power supply output	Encoder signal input
			2	GND	5V negative power supply output	
			3	CLOCK+	Positive end of the clock signal	
			4	CLOCK-	Negative end of the clock signal	
			5	SD	Data signal	
			6	/SD	Data signal	

RS485

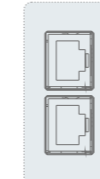

Interface number	Interface name	Interface type	Pin number	Signal marking	Signal name	Interface number	Interface name	Interface type	Pin number	Signal marking	Signal name
X4A	RS485 communication interface input	RJ45 Master Network Port	L1	NC		X4B	RS485 communication interface input	RJ45 Master network port	R1	NC	
			L2	NC					R2	NC	
			L3	NC					R3	NC	
			L4	485-	Data acceptance negative end				R4	485-	Data acceptance negative end
			L5	485+	Data receiving positive end				R5	485+	Data receiving positive end
			L6	NC					R6	NC	
			L7	NC					R7	NC	
			L8	NC					R8	NC	

CAN

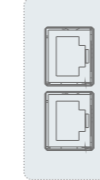

Interface number	Interface name	Interface type	Pin number	Signal marking	Signal name	Interface number	Interface name	Interface type	Pin number	Signal marking	Signal name
X4A	CAN communication interface input	RJ45 Master Network Port	L1	CAN_H	Positive end of the signal	X4B	CAN communication interface input	RJ45 Master network port	R1	CAN_H	Positive end of the signal
			L2	CAN_L	Negative end of the signal				R2	CAN_L	Negative end of the signal
			L3	GNDB	Signal site				R3	GNDB	Signal site
			L4	NC					R4	NC	
			L5	NC					R5	NC	
			L6	NC					R6	NC	
			L7	NC					R7	NC	
			L8	NC					R8	NC	

EtherCAT

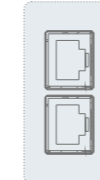

Interface number	Interface name	Interface type	Pin number	Signal marking	Signal name	Interface number	Interface name	Interface type	Pin number	Signal marking	Signal name
X4A	EtherCAT communication interface input	RJ45 Master network port	L1	TD+	Receive signal positive end	X4B	EtherCAT communication interface input	RJ45 Master network port	R1	TD+	Data receiving positive end
			L2	TD-	Receive signal negative end				R2	TD-	Data receiving Negative end
			L3	RD+	Sending signal positive end				R3	RD+	Send signal positive terminal
			L4	NC					R4	NC	
			L5	NC					R5	NC	
			L6	RD-	Sending signal negative end				R6	RD-	Send signal negative terminal
			L7	NC					R7	NC	
			L8	NC					R8	NC	

Profinet

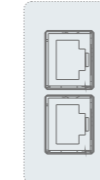

Interface number	Interface name	Interface type	Pin number	Signal marking	Signal name	Interface number	Interface name	Interface type	Pin number	Signal marking	Signal name
X4A	Profinet communication interface input	RJ45 Master network port	L1	TD+	Receive signal positive end	X4B	Profinet communication interface input	RJ45 Master network port	R1	TD+	Receive signal positive end
			L2	TD-	Receive signal negative end				R2	TD-	Receive signal negative end
			L3	RD+	Sending signal positive end				R3	RD+	Sending signal positive end
			L4	NC					R4	NC	
			L5	NC					R5	NC	
			L6	RD-	Sending signal negative end				R6	RD-	Sending signal negative end
			L7	NC					R7	NC	
			L8	NC					R8	NC	

Servo drive mechanical dimensional diagram

FD425-□A-000 mechanical dimensional diagram (unit:mm)

Note: Wiring space needs to be reserved around the drive (recommended > 70 mm)

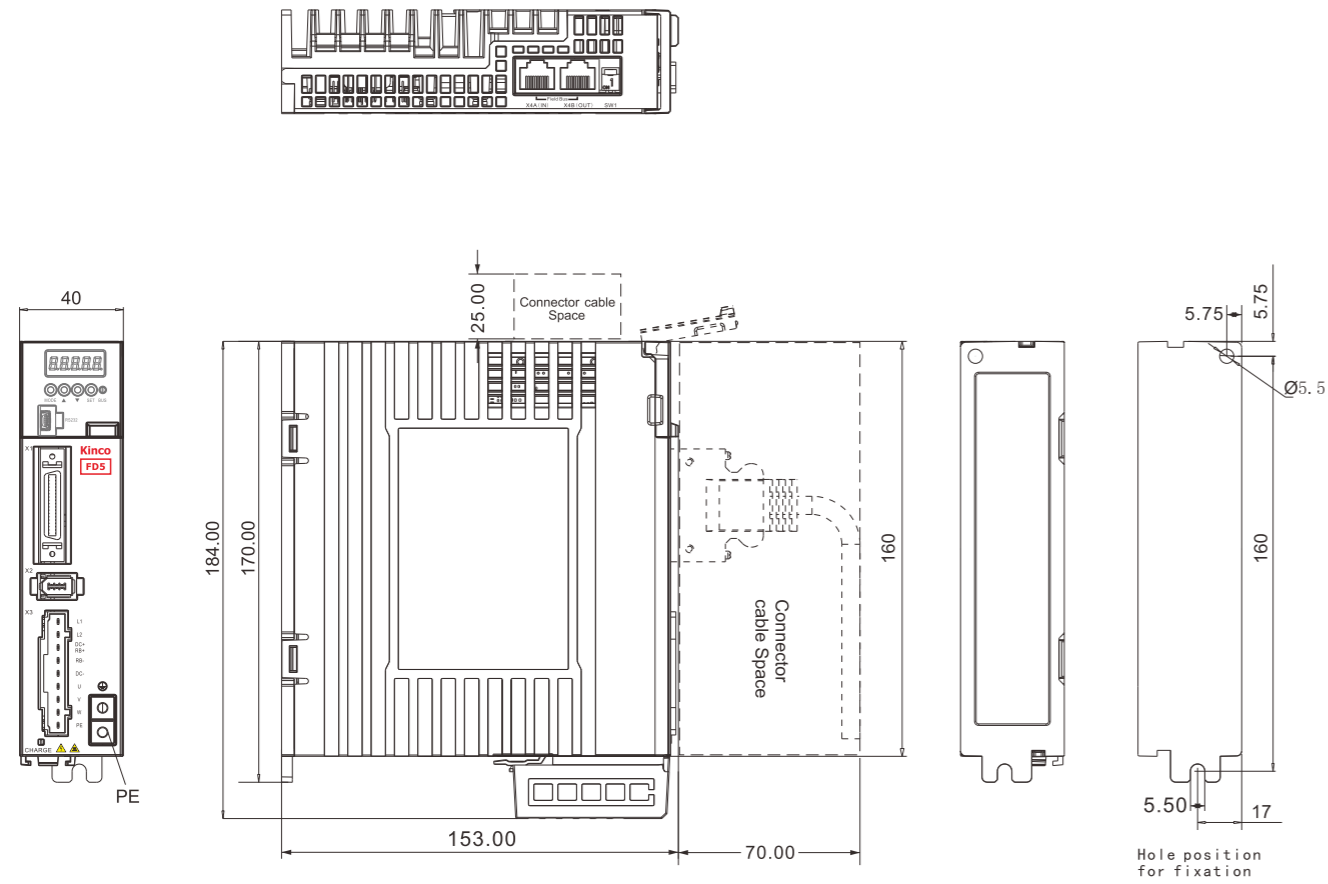

Servo drive mechanical dimensional diagram

FD425-□F-000 mechanical dimensional diagram (unit:mm)

Note: Wiring space needs to be reserved around the drive (recommended > 70 mm)

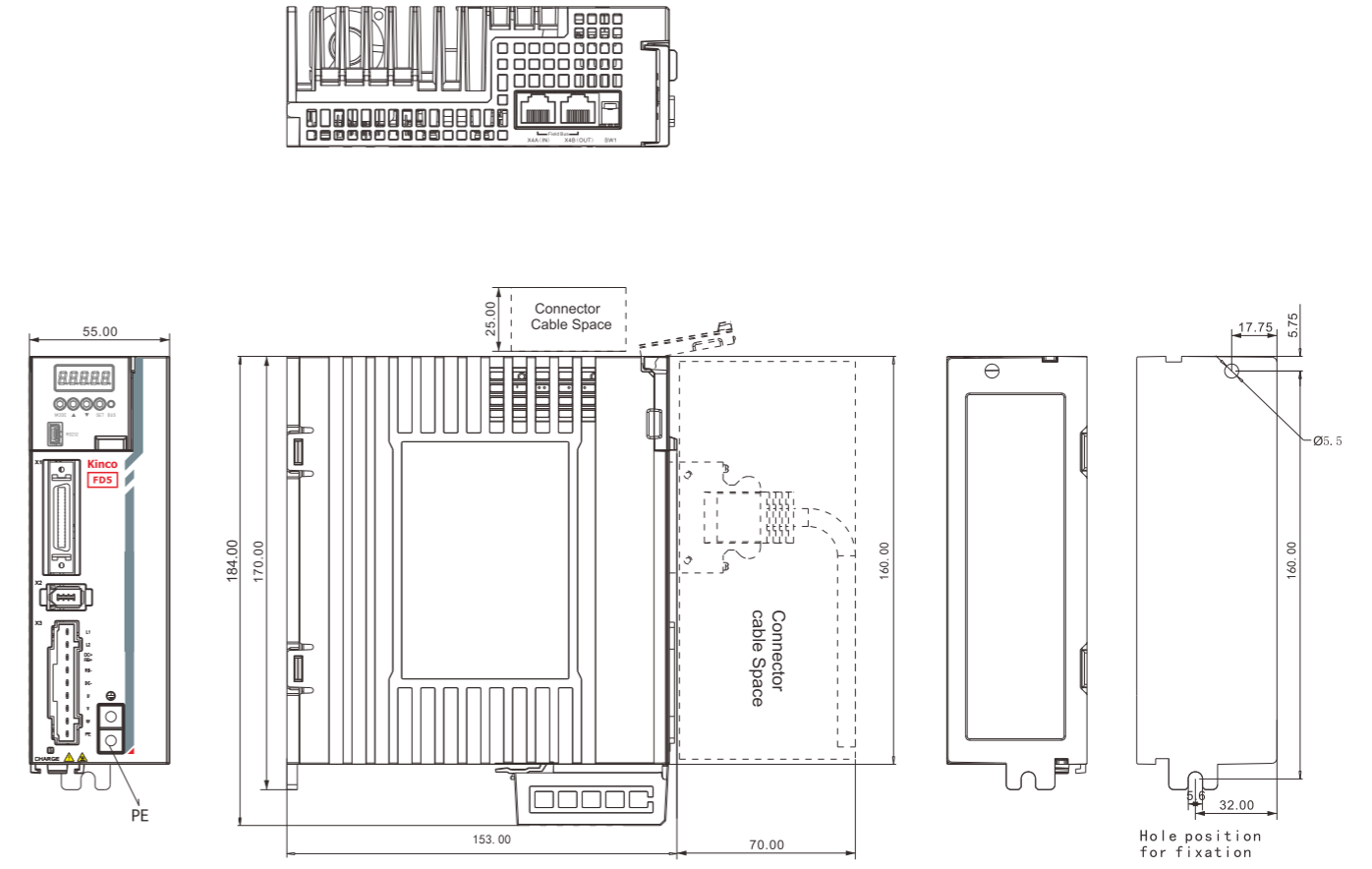

Servo drive mechanical dimensional diagram

FD435-□A-000mechanical dimensional drawing (unit: mm)

Note: Wiring space needs to be reserved around the drive (recommended > 70 mm)

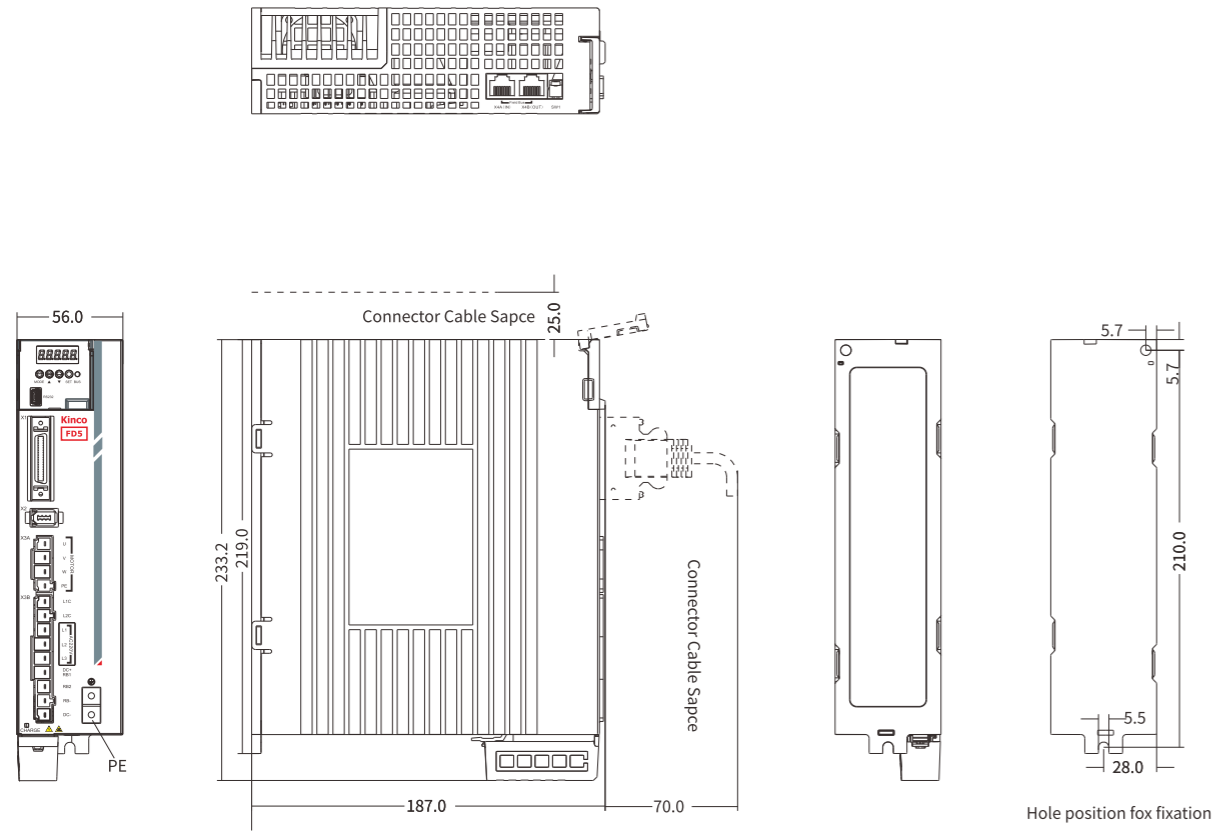

Servo drive mechanical dimensional diagram

FD625-□A-000mechanical dimensional diagram (unit: mm)

Note: Wiring space needs to be reserved around the drive (recommended > 70 mm)

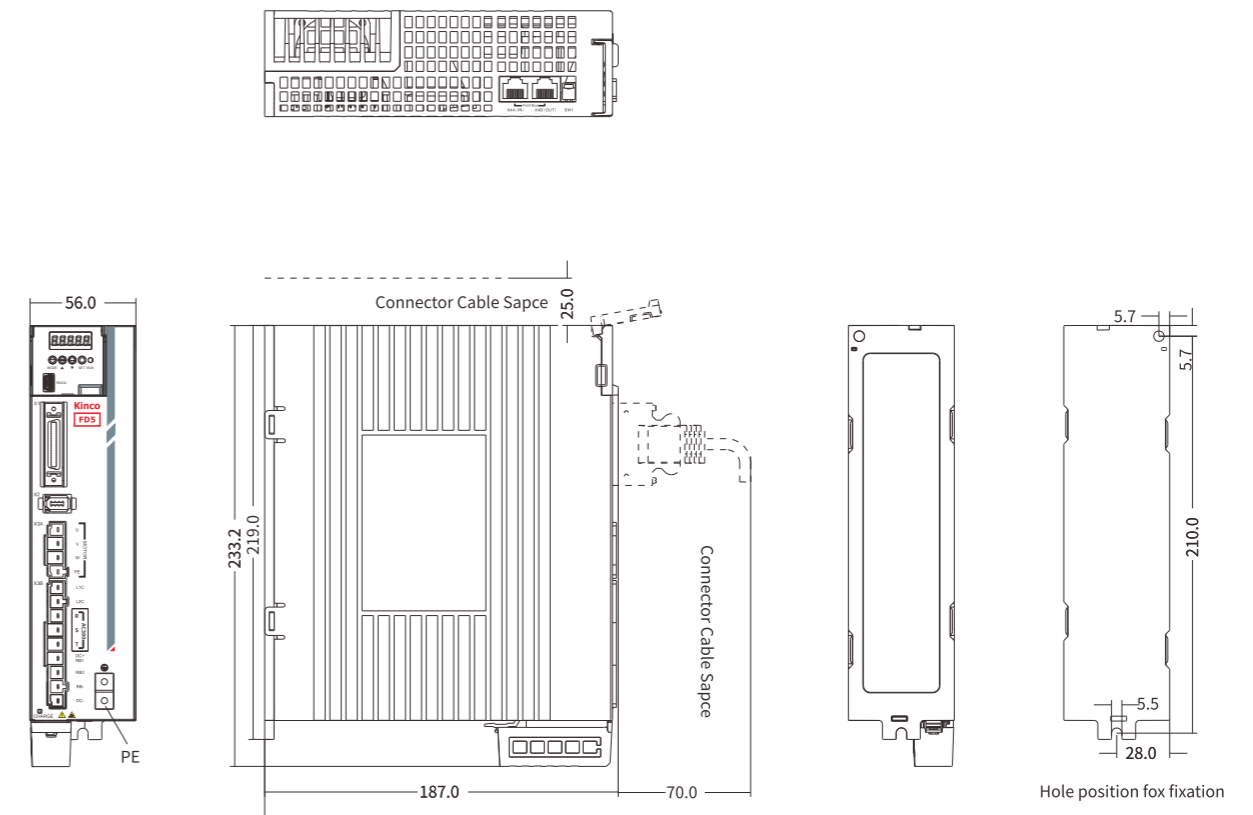

SMC-G2 series high performance servo motor

New electromagnetic design

Adopting 12-slot and 10-pole design, with small slot torque and low torque pulsation, which is conducive to reducing the vibration during the operation of the motor and making the torque output more smooth.

New structure and short fuselage

The redesign of the fuselage structure shortens the length of the fuselage, which can save more installation space and reduce the size of the equipment for customers' equipment.

Insulation class F

The motor in the industry is at the highest insulation level, which can maintain high reliability and stability in high temperature extreme environment.

Energy efficiency class: 2

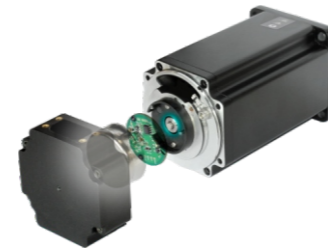

SMG series economical servo motor



SMC60 series servo motor dimensional diagram

60 flange

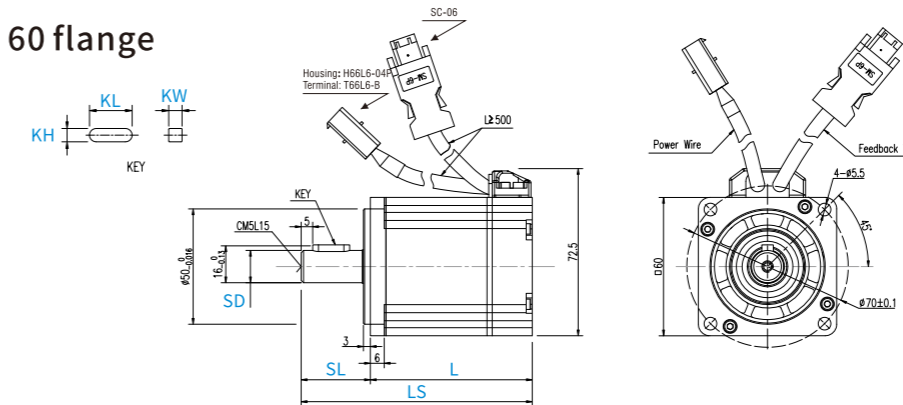

60 flange (with brake)

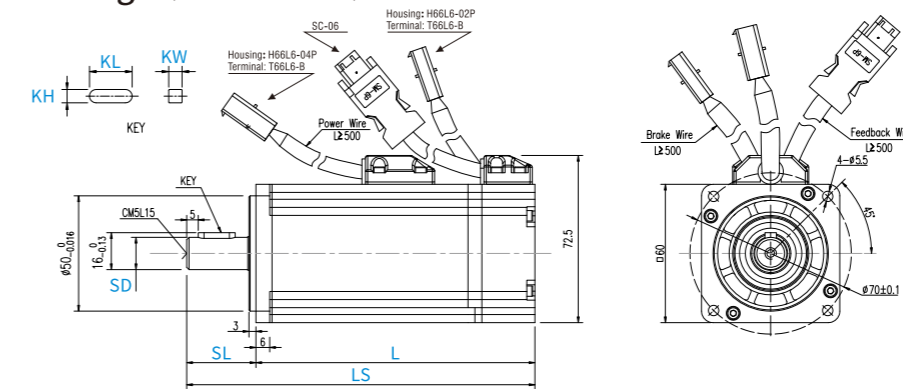

Flange dimension (mm)	Servo motor	With brake	Weight about (KG)	Overall dimension (mm)		Shaft dimension (mm)			Key dimension (mm)		
				LS	L	SL	SD	Screw hole x depth	KL	KW	KH
60x60	SMC60S-0020-30VAK-5LSU		0.9	116.5±1.5	86.5±1.5	30±1	14	M5x15	16	5	5
	SMC60S-0020-30YAK-5LSU			105±1.5	75±1.5						
	SMC60S-0020-30MAK-5LSU			152±1.5	122±1.5						
	SMC60S-0020-30QAK-5LSU			142.5±1.5	112.5±1.5						
	SMC60S-0020-30VBK-5LSU	✓	1.2	138.5±1.5	108.5±1.5						
	SMC60S-0020-30YBK-5LSU			127±1.5	97±1.5						
	SMC60S-0020-30MBK-5LSU			174.5±1.5	144.5±1.5						
	SMC60S-0020-30QBK-5LSU			164.5±1.5	134.5±1.5						
	SMC60S-0040-30VAK-5LSU		1.2	174.5±1.5	144.5±1.5						
	SMC60S-0040-30YAK-5LSU			127±1.5	97±1.5						
	SMC60S-0040-30MAK-5LSU			174.5±1.5	144.5±1.5						
	SMC60S-0040-30MQK-5LSU			164.5±1.5	134.5±1.5						
	SMC60S-0040-30VBK-5LSU	✓	1.6	174.5±1.5	144.5±1.5						
	SMC60S-0040-30YBK-5LSU			127±1.5	97±1.5						
	SMC60S-0040-30MBK-5LSU			174.5±1.5	144.5±1.5						
	SMC60S-0040-30QBK-5LSU			164.5±1.5	134.5±1.5						

SMC60S-0020-30□□K-5LSU

200W

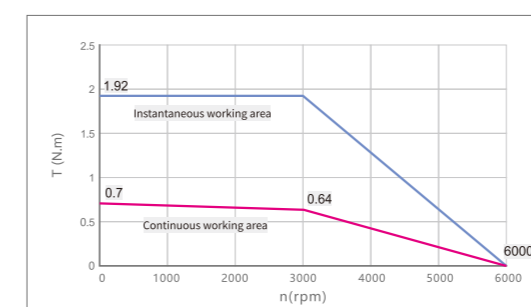

SMC60S-0040-30□□K-5LSU

400W

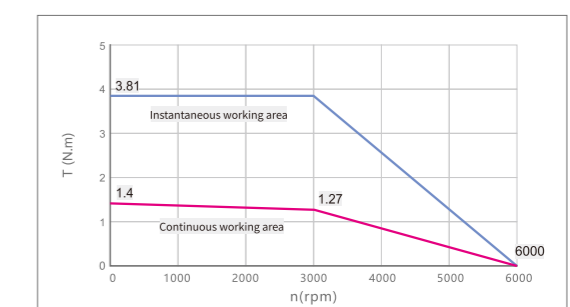

SMC80 series servo motor dimensional diagram

80 flange

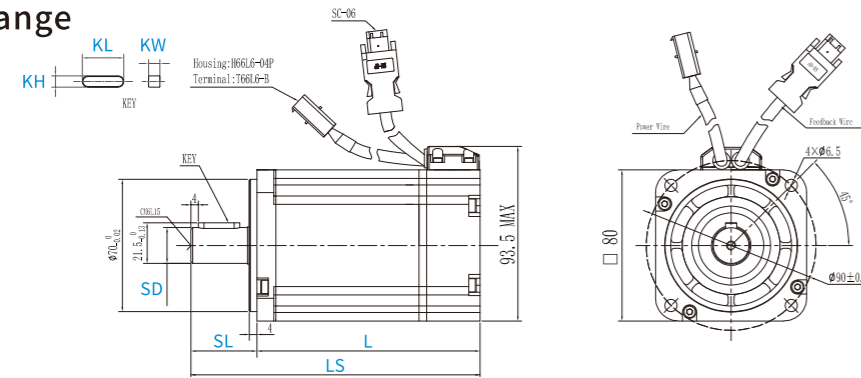

80 flange (with brake)

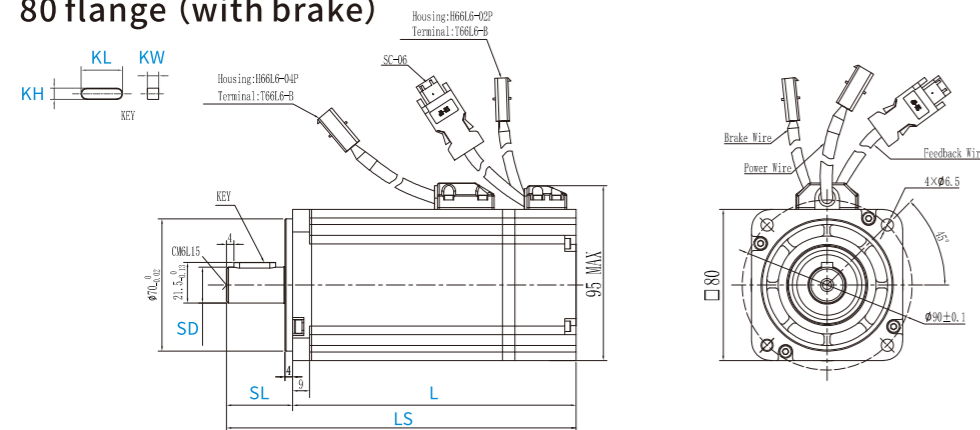

Flange dimension (mm)	Servo motor	With brake	Weight about (KG)	Overall dimension (mm)		Shaft dimension (mm)			Key dimension (mm)		
				LS	L	SL	SD	Screw hole x depth	KL	KW	KH
80x80	SMC80S-0075-30VAK-5LSU		2.3	153.2±1.5	118.2±1.5	35±1	19	M6x15	22	6	6
	SMC80S-0075-30YAK-5LSU										
	SMC80S-0075-30MAK-5LSU										
	SMC80S-0075-30QAK-5LSU										
	SMC80S-0075-30VBK-5LSU	✓	3	185±1.5	150±1.5						
	SMC80S-0075-30YBK-5LSU										
	SMC80S-0075-30MBK-5LSU										
	SMC80S-0075-30QBK-5LSU										

SMC80S-0075-30□□K-5LSU

750W

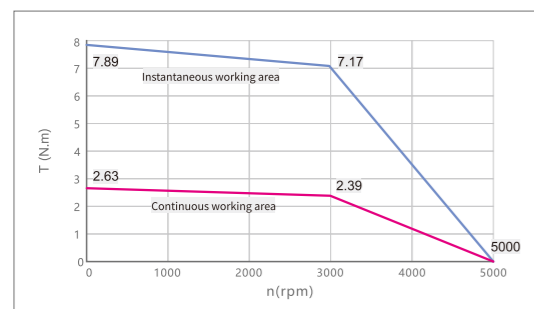

Technical specifications of SMC series servo motor (60/80 flange)



Model parameters		Small inertia, 60 flange		Small inertia, 80 flange	
Servo motor model		SMC60S-0020-30□□K-5LSU	SMC60S-0040-30□□K-5LSU	SMC80S-0075-30□□K-5LSU	
Adapted drives		FD425-LA-000, FD425-CA-000 FD425-EA-000, FD425-PA-000		FD425-LF-000, FD425-CF-000 FD425-EF-000, FD425-PF-000	
Drive power supply voltage		300	300	300	
Intermediate link DC voltage UDC					
Continuous characteristics	Rated power Pn (W)	200	400	750	
	Rated torque Tn (N.m)	0.64	1.27	2.39	
	Rated speed nN (rpm)	3000	3000	3000	
	Rated current In (A)	1.5	2.9	4	
MAX torque Tm (N.m)	1.92	3.81	7.17		
MAX current Im (A)	4.8	9.3	12.6		
Standstill torque Ts (N.m)	0.7	1.4	2.63		
Standstill current Is (A)	1.65	3.2	4.4		
Resistance cable--cable RL (Ω)	9.6	3.72	1.75		
Inductance cable--cable LL (mH)	18.2	8.4	8.1		
Electrical time constant τe (ms)	1.9	2.26	4.63		
Mechanical time constant τm (ms)		1.44	1.06	0.711	
		1.47 (with brake)	1.07 (with brake)	0.76 (with brake)	
Reverse voltage constant Ke (V/krpm)	29	29	40		
Torque constant Kt (N.m/A)	0.48	0.48	0.662		
Rotor moment of inertia Jm (Kg·cm ²)		0.2	0.38	1.027	
		0.204 (with brake)	0.384 (with brake)	1.099 (with brake)	
Brake holding torque T (Nm)	1.5	1.5	3.2		
Number of pole pairs	5	5	5		
MAX voltage rising du/dt (kv/μs)	8	8	8		
Insulation class	F	F	F		
MAX radial force Fr (N)	180	180	335		
MAX axial force Fa (N)	90	90	167.5		
Weight G (Kg)		0.9	1.2	2.3	
		1.2 (with brake)	1.6 (with brake)	3 (with brake)	
Cooling method	Totally enclosed, self-cooling				
Protection level	IP65, IP54 at the shaft end (Note: add oil seal IP54 at the shaft end, no oil seal IP50)				
Operation environment	Temperature	- 20~40°C (no icing)			
	Humidity	Below 90% RH (no condensation)			
	Ambient environment	Keep away from corrosion, flammable gases, oil droplets, dust			
	Altitude	The highest altitude is 4000m. Above 1000m, the power will decrease by 1.5% for every100m rise			

Note: □ = M : Singleturn communication type magnetolectric encoder
 Q : Multiturn communication type magnetolectric absolute encoder
 V : Singleturn communication type optical encoder
 Y : Multiturn communication type optical absolute value encoder

□ = A : Motor without holding brake
 B : Motor with holding brake

SMC130 series servo motor dimensional diagram

130 flange

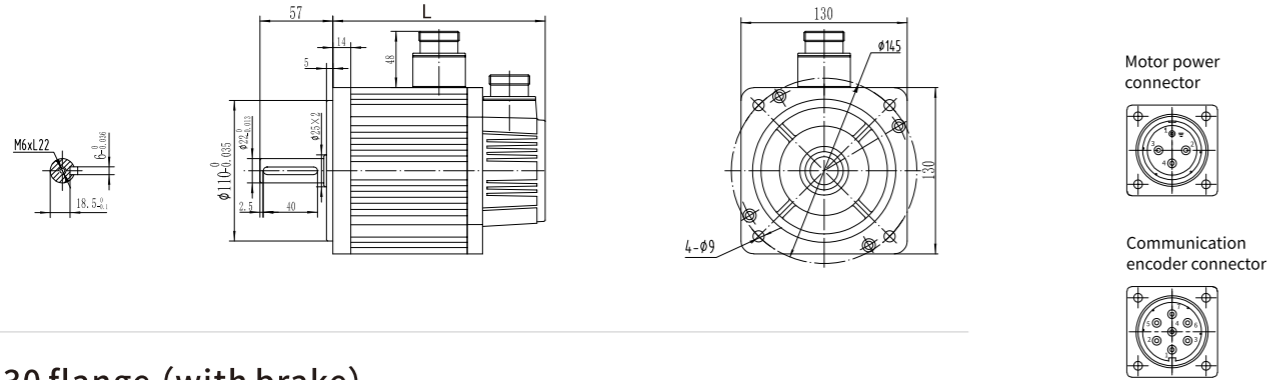

130 flange (with brake)

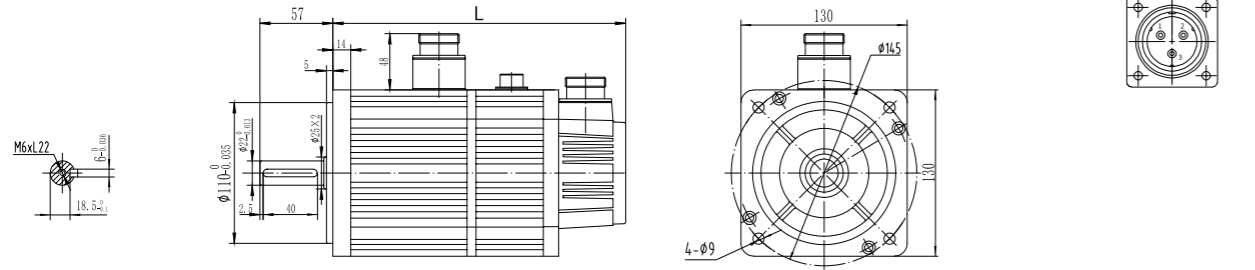

Flange dimension (mm)	Servo motor	With brake	Weight about (KG)	Overall dimension (mm)		Shaft dimension (mm)			Key dimension (mm)		
				LS	L	SL	SD	Screw hole x depth	KL	KW	KH
130x130	SMC130D-0100-10MAK-5LSP		9	226 ± 1.5	171 ± 1.5	55 ± 1	22	M6x18	40	6	6
	SMC130D-0100-20 AK-5LSP		6	198.5 ± 1.5	143.5 ± 1.5						
	SMC130D-0100-20 BK-5LSP	✓	8.5	258.5 ± 1.5	203.5 ± 1.5						
	SMC130D-0150-20 AK-5LSP		8	218.5 ± 1.5	163.5 ± 1.5						
	SMC130D-0150-20 BK-5LSP	✓	10.5	278.5 ± 1.5	223.5 ± 1.5						
	SMC130D-0200-20 AK-5LSP		9.5	234.5 ± 1.5	179.5 ± 1.5						
	SMC130D-0200-20 BK-5LSP	✓	12	294.5 ± 1.5	239.5 ± 1.5						
	SMC130D-0150-20 AK-5HSP		8	258.5 ± 1.5	203.5 ± 1.5						
	SMC130D-0150-20 BK-5HSP	✓	10.5	218.5 ± 1.5	163.5 ± 1.5						
	SMC130D-0150-10MAK-5HSP		12	278.5 ± 1.5	223.5 ± 1.5						
	SMC130D-0200-20 AK-5HSP		9.5	234.5 ± 1.5	179.5 ± 1.5						
	SMC130D-0200-20 BK-5HSP	✓	12	294.5 ± 1.5	239.5 ± 1.5						
	SMC130D-0300-20 AK-5HSP		12	268.5 ± 1.5	213.5 ± 1.5						
	SMC130D-0300-20 BK-5HSP	✓	14.5	328.5 ± 1.5	273.5 ± 1.5						

SMC130 series servo motor size chart

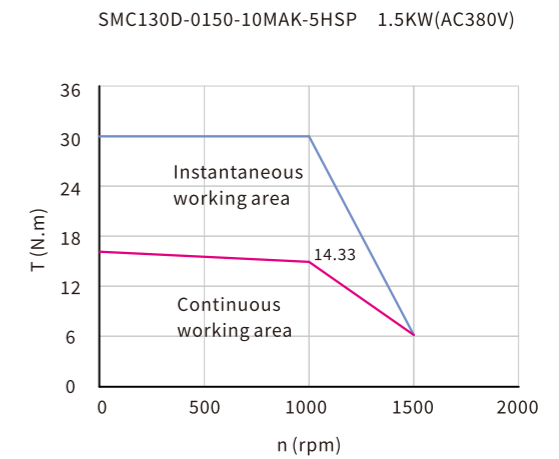
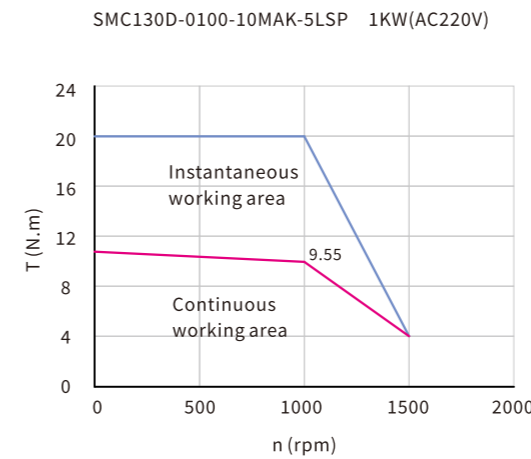
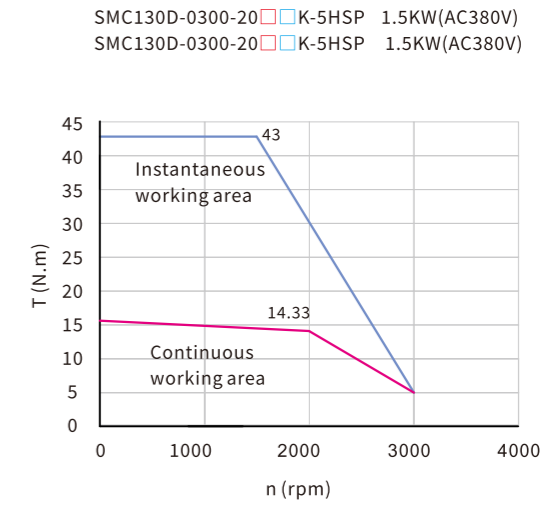
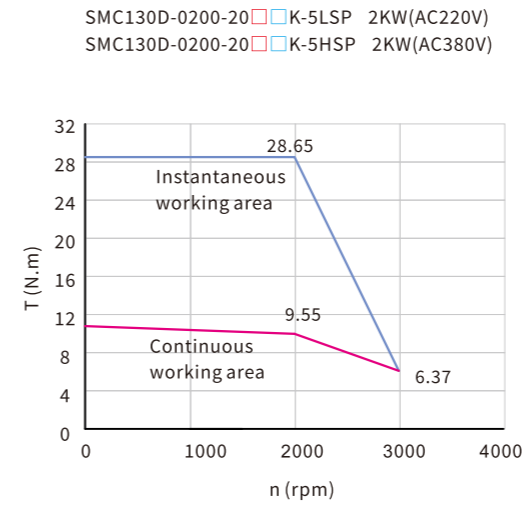
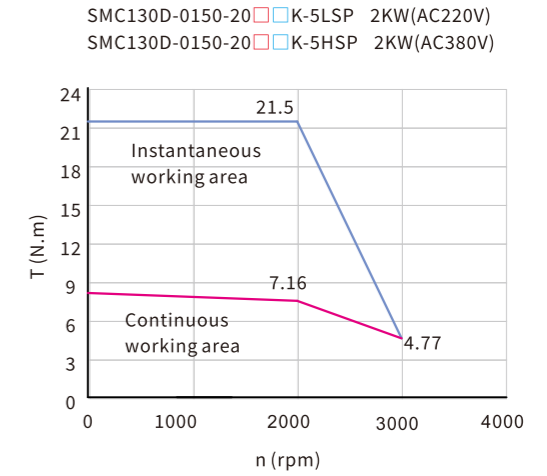
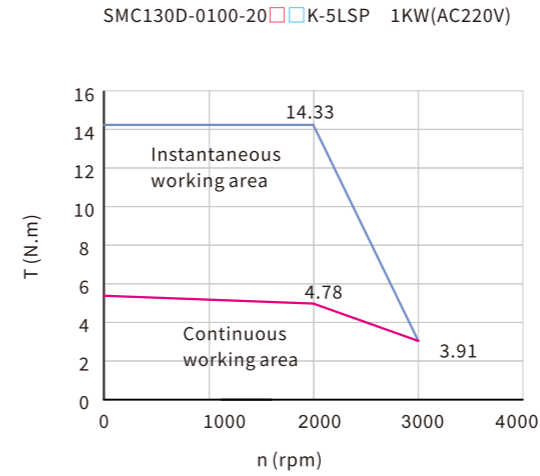

Note: □ = M : Singleturn communication type magnetoelectric encoder
 Q : Multiturn communication type magnetoelectric absolute encoder
 V : Singleturn communication type optical encoder
 Y : Multiturn communication type optical absolute value encoder

Technical specifications of SMC series servo motor (130 flange)



Model parameters		Medium inertia, 130 flange							
Servo motor model		SMC130D-0100-20□□K-5LSP	SMC130D-0100-10MAK-5LSP	SMC130D-0150-20□□K-5LSP	SMC130D-0200-20□□K-5LSP	SMC130D-0150-20□□K-5HSP	SMC130D-0150-10MAK-5HSP	SMC130D-0200-20□□K-5HSP	SMC130D-0300-20□□K-5HSP
Adapted drives		FD425-LF-000, FD425-CF-000 FD425-EF-000, FD425-PF-000		FD435-LA-000, FD435-CA-000 FD435-EA-000, FD435-PA-000		FD625-LA-000, FD625-CA-000 FD625-EA-000, FD625-PA-000			
Drive power supply voltage Intermediate link DC voltage UDC		320	320	320	320	560	560	560	560
Continuous performance	Rated power Pn(W)	1	1	1.5	2	1.5	1.5	2	3
	Rated torque Tn(Nm)	4.78	9.55	7.16	9.55	7.16	14.33	9.55	14.33
	Rated speed nN(rpm)	2000	1000	2000	2000	2000	1000	2000	2000
	Rated current In(A)	4.5 (ref.)	4.6 (ref.)	7.7 (ref.)	9.5 (ref.)	3.85 (ref.)	3.8 (ref.)	4.75 (ref.)	7 (ref.)
MAX torque Tm(Nm)	14.34	20	21.5	28.65	21.5	30	28.65	43	
MAX current Im (A)	14.5 (ref.)	10 (ref.)	25 (ref.)	30 (ref.)	12.5 (ref.)	7.6 (ref.)	15 (ref.)	22.7 (ref.)	
Resistance cable-cable RL(Ω)	1.54 (ref.)	2.27 (ref.)	0.63 (ref.)	0.48 (ref.)	2.48 (ref.)	6.23 (ref.)	1.92 (ref.)	1.34 (ref.)	
Inductance cable-cable LL(mH)	13.8 (ref.)	27.9 (ref.)	6.9 (ref.)	5.8 (ref.)	22.65 (ref.)	83 (ref.)	18.6 (ref.)	18.45 (ref.)	
Electrical time constant τe (ms)	8.96	12.3	10.95	12.08	9.13	13.3	9.69	13.75	
Mechanical time constant τm (ms)		1.9	1.24	1.42	1.24	1.7	1.09	1.53	1.06
		2.1(with brake)	-	1.48(with brake)	1.3(with brake)	1.81(with brake)	-	1.61(with brake)	1.08(with brake)
Reverse voltage constant Ke (V/krpm)		73.4 (ref.)	144 (ref.)	66.9 (ref.)	70.35 (ref.)	121.3 (ref.)	312 (ref.)	126.5 (ref.)	154.8 (ref.)
Torque constant Kt (Nm/A)		1.21	2.38	1.1	1.16	2	5.16	2.1	2.56
Rotor moment of inertia Jm (Kg·cm ²)		10.6	17.82	15.95	20.25	15.95	27	20.25	30
		11.6(with brake)	-	16.95(with brake)	21.25(with brake)	16.95(with brake)	-	21.25(with brake)	31(with brake)
Brake holding torque T(Nm)		15	-	15	15	15	-	15	15
Number of pole pairs		5	5	5	5	5	5	5	
Insulation class		F	F	F	F	F	F	F	
Max radial force Fr(N)		980	900	980	980	980	980	980	
Max axial force Fa(N)		392	450	392	392	392	392	392	
Weight G(Kg)		6	9	8	9.5	8	12	9.5	12
		8.5(with brake)	-	10.5(with brake)	12(with brake)	10.5(with brake)	-	12(with brake)	14.5(with brake)
Fuselage length L(mm)		143.5±1.5	171±1.5	163.5±1.5	179.5±1.5	163.5±1.5	203.5±1.5	179.5±1.5	213.5±1.5
		203.5±1.5(with brake)	-	223.5±1.5(with brake)	239.5±1.5(with brake)	223.5±1.5(with brake)	-	239.5±1.5(with brake)	273.5±1.5 (带抱闸)
Cooling method		Totally enclosed, self-cooling							
Protection level		IP65, IP54 at the shaft end (Note: add oil seal IP54 at the shaft end, no oil seal IP50)							
Operation environment	Temperature	- 20~40°C (no icing)							
	Humidity	Below 90% RH (no condensation)							
	Ambient environment	Keep away from corrosion, flammable gases, oil droplets, dust							
	Altitude	The highest altitude is 4000m. Above 1000m, the power will decrease by 1.5% for every 100m rise.							

Note: □ = V : Singleturn communication type optical encoder
 Y : Multiturn communication type optical absolute value encoder
 M : Singleturn communication type magnetoelectric encoder
 Q : Multiturn communication type magnetoelectric absolute encoder
 □ = A : Motor without brake
 B : Motor with brake

SMG60 series servo motor dimension

60 flange

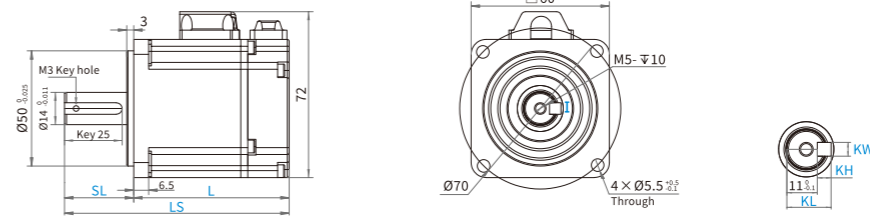

60 flange (with brake)

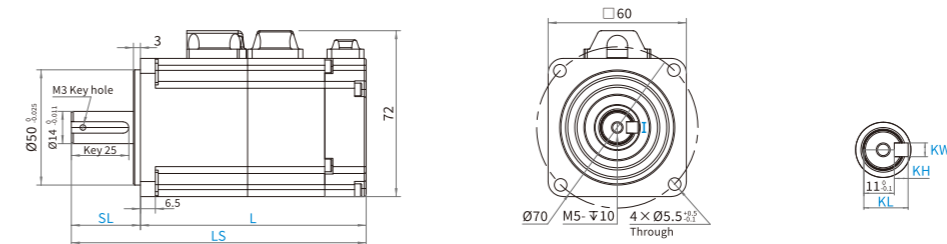

Flange dimension (mm)	Servo motor	With brake	Weight about (KG)	Overall dimension (mm)		Shaft dimension (mm)			Key dimension (mm)		
				LS	L	SL	SD	Screw hole x depth	KL	KW	KH
60x60	SMG60S-0020-30MAK-5LSQ		0.78	97.5±1.5	67.5±1.5	30±1	14	M5x10	16	5	5
	SMG60S-0020-30QAK-5LSQ										
	SMG60S-0020-30MBK-5LSQ	✓	1.2	128±1.5	98±1.5						
	SMG60S-0020-30QBK-5LSQ										
	SMG60S-0040-30MAK-5LSQ		1.2	115.5	85.5±1.5						
	SMG60S-0040-30QAK-5LSQ										
	SMG60S-0040-30MBK-5LSQ	✓	1.6	146±1.5	116±1.5						
	SMG60S-0040-30QBK-5LSQ										

SMG60S-0020-30□□K-5LSQ

200W

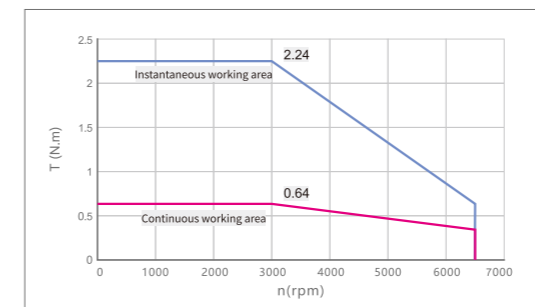

SMG60S-0040-30□□K-5LSQ

400W

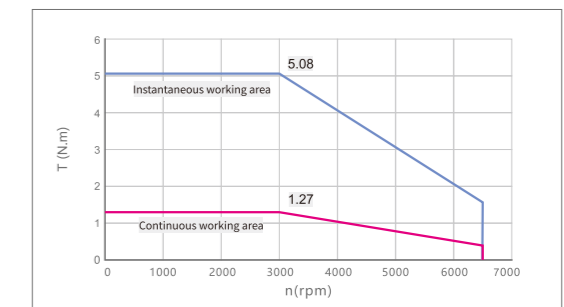

SMG80 series servo motor dimension

80 flange

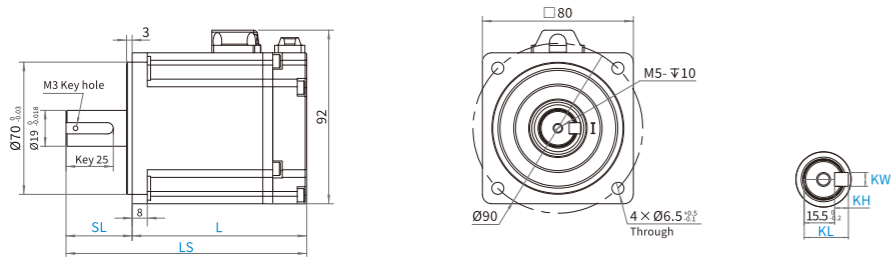

80 flange (with brake)

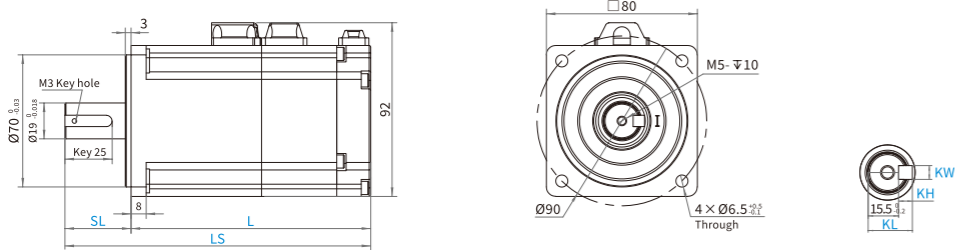

Flange dimension (mm)	Servo motor	With brake	Weight about (KG)	Overall dimension (mm)		Shaft dimension (mm)			Key dimension (mm)		
				LS	L	SL	SD	Screw hole x depth	KL	KW	KH
80x80	SMG80S-0075-30MAK-5LSQ		2.1	127.5±1.5	92.5±1.5	35±1	19	M5x10	21.5	6	6
	SMG80S-0075-30QAK-5LSQ										
	SMG80S-0075-30MBK-5LSQ	✓	2.9	162±1.5	127±1.5						
	SMG80S-0075-30QBK-5LSQ										

SMG80S-0075-30□□K-5LSQ

750W

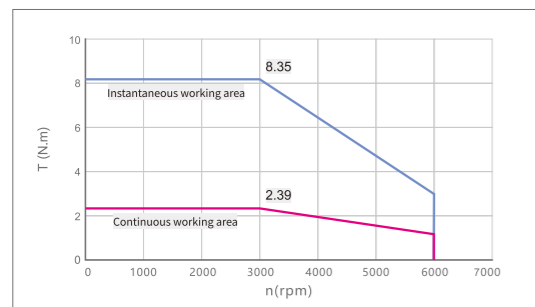

Technical specifications of SMG series servo motor (60/80 flange)



Model parameter		Small inertia, 60mm flange		Small inertia, 80mm flange	
Servo motor		SMG60S-0020-30□□K-5LSQ		SMG60S-0040-30□□K-5LSQ	
				SMG80S-0075-30□□K-5LSQ	
Continuous performance	Rated power Pn (W)	200	400	750	
	Rated torque Tn (N.m)	0.64	1.27	2.39	
	Rated speed nN (rpm)	3000	3000	3000	
	Rated current In (A)	1.6	2.6	4.6	
MAX torque Tm (N.m)		2.24	5.08	8.35	
MAX current Im (A)		5.6	10.9	17.5	
Standstill torque Ts (N.m)		0.76	1.4	2.86	
Standstill current Is (A)		1.9	2.86	5.5	
Resistance Line - Line RL (Ω)		7.3	4.2	1.3	
Inductance Line - Line LL (mH)		14.7	9.8	6.8	
Electrical time constant τe (ms)		2	2.4	5.2	
Mechanical time constant τm (ms)		1.39	1.3	1.26	
Reverse voltage constant Ke (V/krpm)		26.9	34.1	33.5	
Torque constant Kt (N.m/A)		0.4	0.488	0.519	
Rotor moment of inertia Jm (Kg·cm ²)		0.28	0.56	1.56	
Brake holding torque T (Nm)		1.58	1.58	3.8	
Pole pair number		5	5	5	
MAX voltage rising du/dt (kv/μs)		8	8	8	
Insulation class		F	F	F	
MAX radial force Fr (N)		245	245	392	
MAX axial force Fa (N)		74	74	147	
Weight G (Kg)		0.78	1.2	2.1	
		1.2 (with brake)	1.6 (with brake)	2.9 (with brake)	
Cooling method		Forced air cooling of the servo motor from the outside with a cooling fan			
Protection level		IP65 (shaft through part)			
Operation environment	Temperature	0~40°C (without freezing)			
	Humidity	20~80% (no condensation)			
	Ambient environment	Keep away from corrosion, flammable gas, oil droplets, dust			
	Altitude	Below 1000m, please derate for use above 1000m			

Note: 1. □ = M : Magnetic single-turn absolute encoder
□ : Magnetic multi-turn absolute encoder

□ = A : Motor without holding brake
B : Motor with brake

- The motor is installed on the aluminum heat sink (size: 400x400x20mm), and the data when it runs to a stable state.
- Data of winding temperature at 20°C.
- Forced air cooling of the servo motor from the outside with a cooling fan.

Cable wiring instructions (encoder cable)

ENCDG-LL-GU
 Wire spec.:UL2661 1P×20AWG+2P×24AWG
 20AWG cross section area is 0.5189mm²
 24AWG cross section area is 0.2047mm²

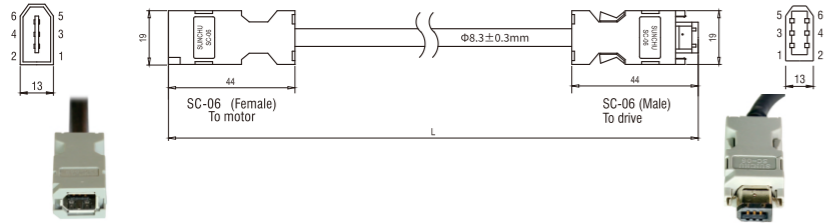

SC-06	Color	Signal 1	Signal 2
PIN1	Red	VDD	+5V
PIN2	Black	GND	GND
PIN3	Brown	MA_P+	BAT+
PIN4	Blue	MA_N-	BAT-
PIN5	Yellow	SLO_P+	SD
PIN6	Green	SLO_N-	/SD
Shell	Shield	Shield	Shield

Note: Signal 1 is suitable for magneto-electric encoder; signal 2 is suitable for absolute encoder;
 Cable: ENCDG-GU
 Flexible cable: ENCDGF-LL-GU
 Cable specifications: 1P x 20AWG(72/0.10T)+2P x 24AWG(32/0.10T)
 Cable diameter: 7.4±0.5mm

ENCDG-LL-GQ
 Wire spec.:UL2661 1P*20AWG(26/0.16T)+2P*24AWG(11/0.16T)
 20AWG cross section area is 0.5189mm²
 24AWG cross section area is 0.2047mm²

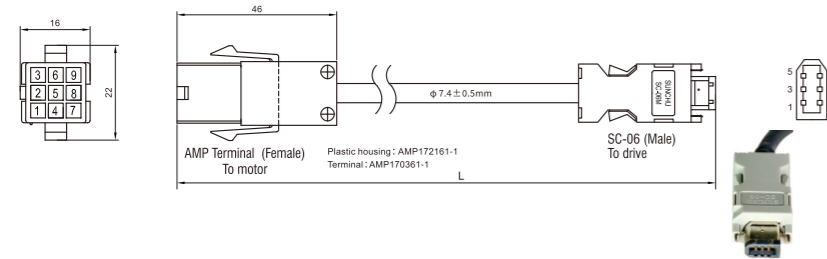

Color	AMP	SC-06	Signal
Red	PIN2	PIN1	+5V
Black	PIN3	PIN2	0V
Brown	PIN6	PIN3	BAT+
Blue	PIN7	PIN4	BAT-
Yellow	PIN4	PIN5	PS
Green	PIN5	PIN6	/PS
Shield	PIN1	Shell	Shield

ENCDG-(4)-GU-BT5
 Wire spec.:3×2×0.2mm²

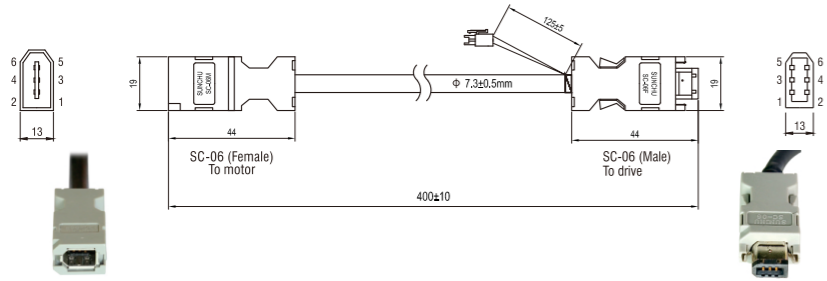

SC-06F	Color	Signal	SC-06M	Black HSG	External single
PIN1	Red	+5V	PIN1		
PIN2	Black	GND	PIN2		
PIN3	Brown	BAT+		PIN1	Red
PIN4	Blue	BAT-		PIN2	Black
PIN5	Yellow	SD	PIN5		
PIN6	Green	/SD	PIN6		
Shell	Shield	Shield	Shell		

Optional battery case for FD5
 BAT-FD5, suitable for absolute encoder motor, matching with ENCDG-(4)-GU-BT5

Cable wiring instructions (power cable)

MOT-005-LL-KL-NS
 Wire spec.:UL2517 4 X 18AWG
 18AWG cross section area is 0.8107mm²

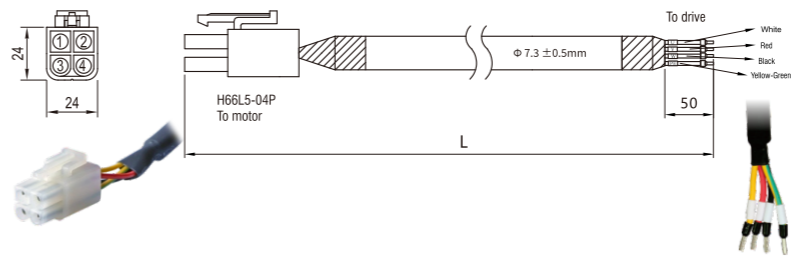

Color	Signal	4PIN
White	U	PIN1
Red	V	PIN3
Black	W	PIN2
Yellow-Green	PE	PIN4

Note: Corresponding accessory MOT-KL

MOT-005-LL-KQ-NS
 Wire spec.:UL2517 4 X 18AWG
 18AWG cross section area is 0.8107mm²

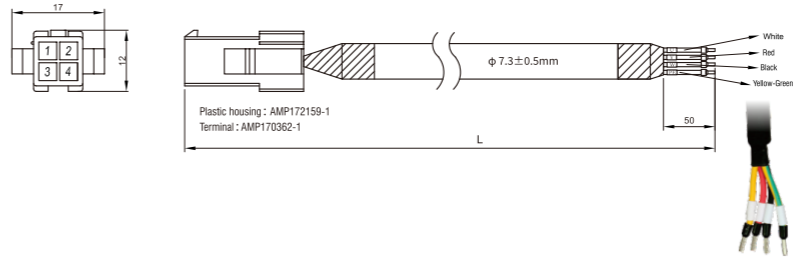

Color	Signal	AMP
White	U	PIN1
Red	V	PIN3
Black	W	PIN2
Yellow-Green	PE	PIN4

MOT-008-LL-KG1-NS
 Wire spec.: UL2588 4 X 1.5mm²

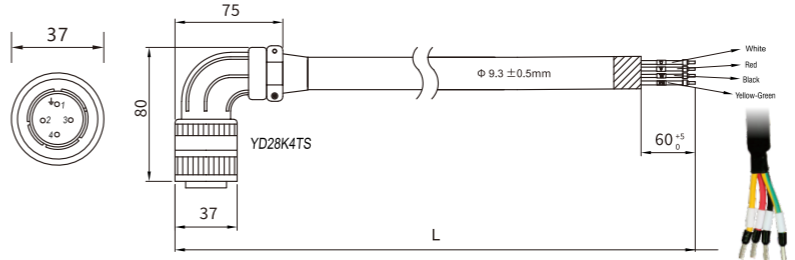

Color	Signal	YD28K4TS
White	U	PIN2
Red	V	PIN3
Black	W	PIN4
Yellow-Green	PE	PIN1

Note: Corresponding accessory MOT-KG1

MOT-015-LL-KG1
 Wire spec.:4*14AWG(50/0.25T)
 14AWG cross section area is 2.075mm²

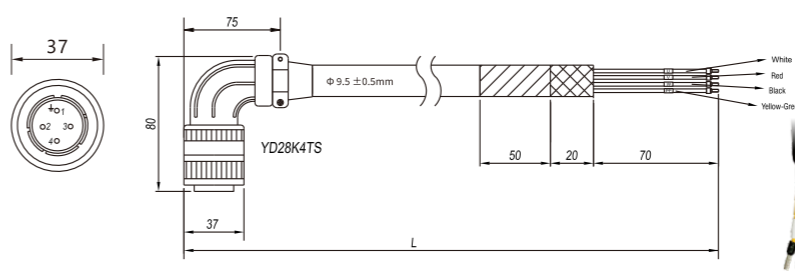

Color	Signal	YD28K4TS
White	U	PIN2
Red	V	PIN3
Black	W	PIN4
Yellow-Green	PE	PIN1
Shielded wire	Shield	PIN1

Cable wiring instructions (power cable)

MOT-005-LL-KC4
 Wire spec: 4C*18AWG(41/0.16T)
 18AWG cross section area is 0.8107mm²

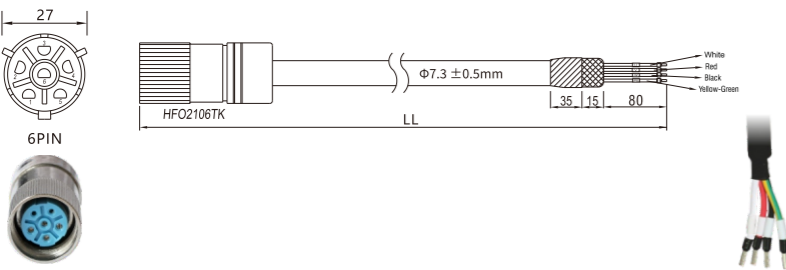

Color	Signal	HFO2106TK
White	U	PIN2
Red	V	PIN3
Black	W	PIN4
Yellw-Green	PE	PIN6

Note:
 Accessories: **MOT-005-KC4**
 Flexible cable: **MOTF-005-LL-KC4**
 Flexible cable: 4C*18AWG(7/18/0.10T) 500万次
 Cablediameter: 7.3 ± 0.5mm

MOT-005-LL-KC4-B
 Wire spec: 4*18AWG+2*20AWG BLACK
 18AWG cross section area is 0.8107mm²
 20AWG cross section area is 0.5189mm²

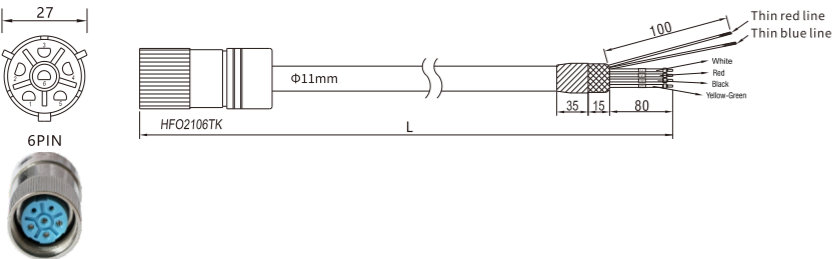

Color	Signal	HFO2106TK
White	U	PIN2
Red	V	PIN3
Black	W	PIN4
Yellw-Green	PE	PIN6
Thin red line	brake+	PIN1
Thin blue line	brake-	PIN5
Shielded wire	Shielded	Shell

Note:
 Accessories: MOT-KC4-B

MOT-008-LL-KC4
 Wire spec: 4X16AWG
 16AWG cross section area is 1.318mm²

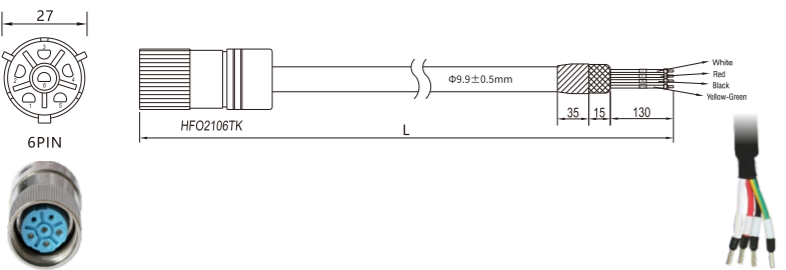

Color	Signal	HFO2106TK
White	U	PIN2
Red	V	PIN3
Black	W	PIN4
Yellw-Green	PE	PIN6

Note:
 Accessories: **MOT-KC4-B**
 Flexible cable: **MOTF-008-LL-KC4**
 Cablespecifications: 4X1.5mm², BLACK
 Cablediameter: 9.3 ± 0.5mm

MOT-008-LL-KC4-B
 Wire spec: 4*1.5+2*0.5

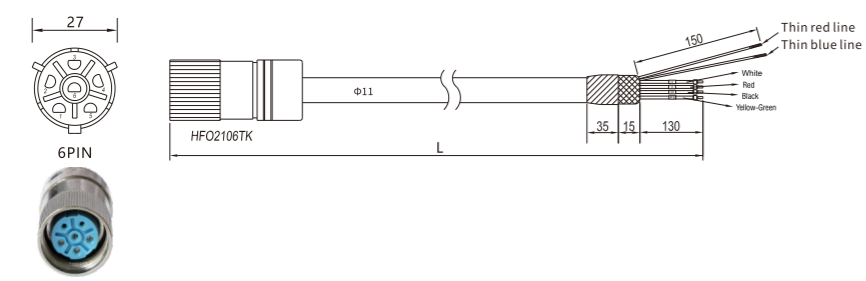

Color	Signal	HFO2106TK
White	U	PIN2
Red	V	PIN3
Black	W	PIN4
Yellw-Green	PE	PIN6
Thin red line	brake+	PIN1
Thin blue line	brake-	PIN5

Note:
 Accessories: **MOT-KC4-B**

Cable wiring instructions (brake cable)

BRA-LL-KL
 Wire spec.: 2C*20AWG
 20AWG cross section area is 0.5189mm²

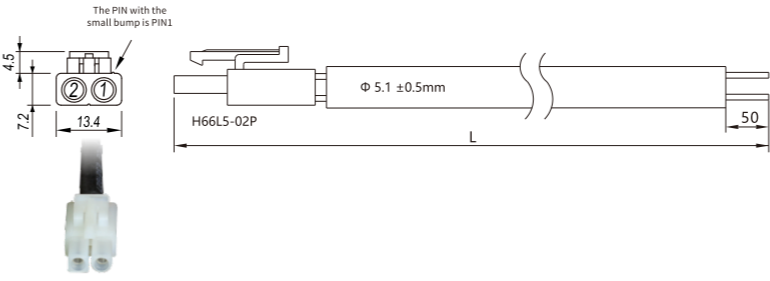

Color	Signal	2PIN
Red	brake+	PIN1
Blue	brake-	PIN2

Note:
 Accessories: BRA-KL
 Flexible cable: BRAF-LL-KL
 Cable specifications: 2C*20AWG(72/0.10T)
 Cable diameter: 5.5 ± 0.2mm

BRA-LL-KQ
 Wire spec.: UL2464 2 X 20AWG
 20AWG cross section area is 0.5189mm²

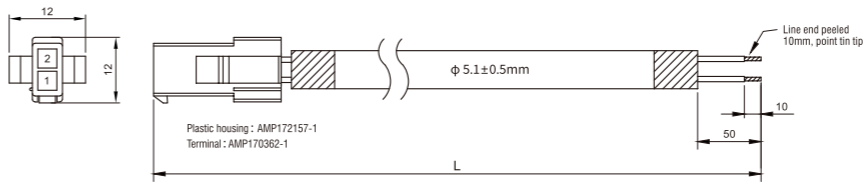

Color	Signal	AMP
Blue	0V	PIN1
Red	24V	PIN2