

Braking Device
VersiBrake Safe
Assembly- and Commissioning Instructions

Original

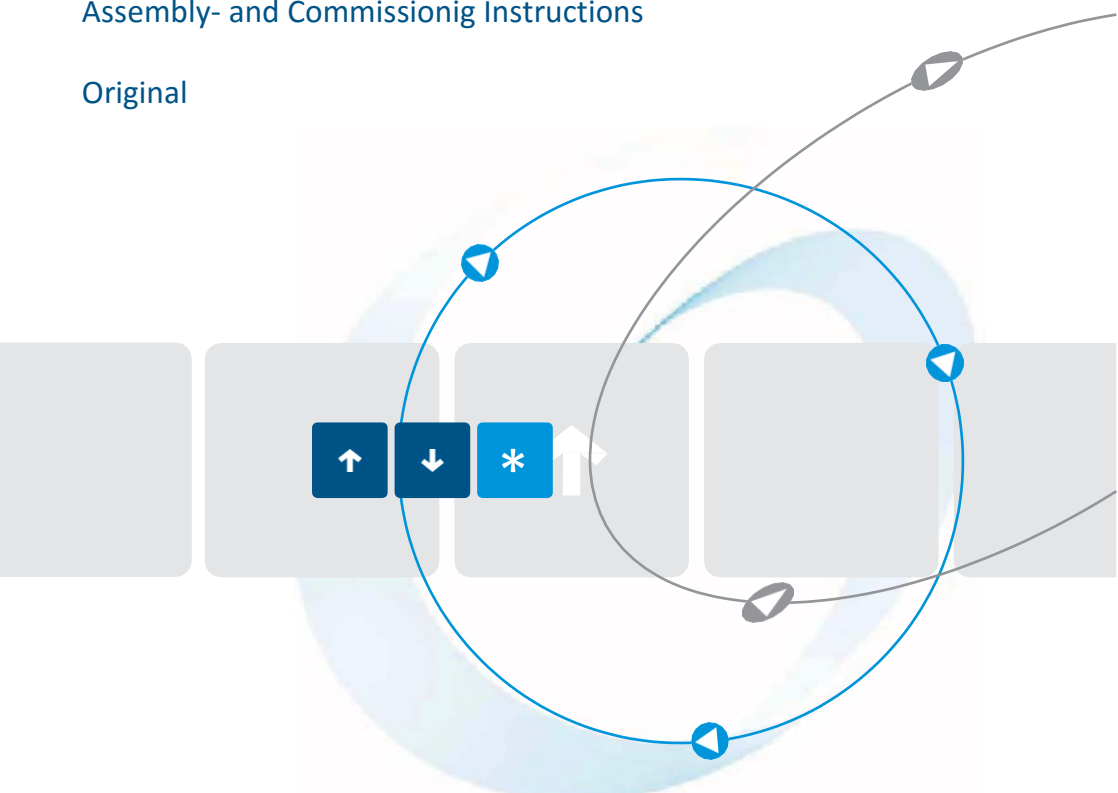

Quality is our Drive.

As per 07/19 1B500.10001

Table of Contents	Page
1. Safety information.....	5
1.1 Notes on safety.....	5
1.2 Warning note.....	6
2. Conformity.....	6
3. General description.....	7
4. Utilisation according to specification.....	8
4.1 Foreseeable incorrect usages.....	8
5. EU Declaration of Conformity.....	9
6. Declaration related to functional safety.....	10
7. Block diagram.....	11
8.1 Installation information.....	13
8.2 Connection.....	15
8.3 Parameter adjustments.....	16
8.4 LCD operator panel / menu language.....	17
8.4.1 Display / Operation.....	18
8.4.2 Programming mode.....	28
8.4.3 Description of the adjustable parameters.....	29
8.4.4 Fault mode.....	35
8.4.5 Operating sequence.....	36
8.5 System reset.....	38
9. Braking.....	38
9.1 Standstill-dependent braking with braking time optimisation.....	38
9.2 Safety time.....	39
10. Thermal overload protection.....	39
10.1 Motor temperature monitoring.....	39
10.2 Device temperature monitoring.....	40
10.2.1 thermal device image.....	40
10.2.2 Heatsink / device temperature.....	41
11. Extended, optional operation functions.....	42
11.1 External motor-standstill monitor.....	42
11.2 Recording tool speed.....	43
11.3 Manual Brake cancellation.....	44
11.4 Star delta start-up.....	44
12. Operational signals.....	46
13. Faults.....	47
13.1 Combined fault.....	47
13.2 Device fault.....	49

13.3	Reset fault.....	51
14.	CAN-BUS	51
15.	Technical data	52
15.1	General specifications.....	52
15.2	EMC Information.....	53
15.3	Environmental conditions	54
15.4	Safety specifications	54
15.5	Dimensions	55
16.	Dimensioning rules	55
16.1	Dimensioning of fuses for device protection	55
16.2	Motor protection switch	57
17.	Installation guideline	57
17.1	Connection.....	57
17.2	Earthing	57
17.3	Cabling	57
18.	General connection diagram	59
19.	Timing diagram	60
19.1	Switch-on of the control voltage 24 V DC	60
19.2	Switch-on of the 24 V DC control voltage and the mains voltage.....	60
19.3	Start/Stop procedure	61
19.4	Switch-on of the voltages if motor rotates.....	61
19.5	Occurrence of an device fault.....	62
19.6	Occurrence of a Combined fault.....	62

These instructions must be read and understood before installation, operation or servicing of the appliance muss.

These commissioning instructions were prepared with great care. Nevertheless, PETER electronic GmbH & Co. KG does not assume liability for damage resulting from mistakes possibly contained in this manual. Technical changes that serve to improve the product are subject to change without notice.



Installation notice

Electro-technical specialist knowledge is required for installation and commissioning.



Disposal Instructions

Equipment containing electrical components may not be disposed of together with domestic waste. It must be collected separately as electrical and electronic waste according to local and currently valid legislation.

Notes and symbols used in these instructions

Note: Notes explain the advantages of certain adjustments or settings and help you to make use of the device in the best possible way.



Warning notices: Read them carefully and follow them strictly

Warning notices are indicated in order to protect you against danger or to help you to prevent the device from being damaged.



Caution: Danger to life through electric shock!

When you see this sign, always make sure that the device is de-energized and secured against unintentional energizing.

1. Safety information

1.1 Notes on safety

The appliance may only be used for the purposes stated in the applicable fitting and commissioning instructions. The notices in the accompanying documents must be followed. The permissible environmental conditions must be adhered to.

Fit the appliance in a switch cabinet with IP 54 or better. Dust and moisture could otherwise lead to negative effects on the function.



The described devices are operating resources which are used in industrial power installations. Inadmissible removal of coverings during operation can cause serious damage to health, since live parts with high voltages are present in these devices.

Installation, maintenance and adjustment work, as well as the operation, may be carried out only by instructed personnel in accordance with the safety regulations. Installation work may be implemented in the de-energised status only.

Note proper grounding of all drive components.

Before you put the device into operation, please read this start-up instruction carefully.

The user has to furthermore ensure that the devices and the relevant components are mounted and connected according to public, legal and technical specifications. The VDE Specifications VDE 0100, VDE 0110 (EN 60664), VDE 0160 (EN 50178), VDE 0113 (EN 60204, EN 61310) and VDE 0660 (EN 50274), as well as corresponding specifications of TUEV and Trades Social Insurance against Occupational Accidents, apply for Germany.

It must be ensured by the user that after a failure of the device, in case of faulty operation, in case of failure of the control unit and so forth, the drive is brought into a secure operating state.

1.2 Warning note



- The safety functions of the VB S (see point 3. General description) are only applicable in connection with further measures, e.g. protective door interlock
- In the case of an error it can not be excluded that the engine will start to turn. This must be observed especially when the safety door is open. This can be prevented if it is constructively ensured on the drive side that the motor does not start up with 2 mains phases (two-pole motor or heavy motor start).
- The unbraked run down of the motor to a standstill must not exceed 300s. Here the highest possible rotational speed and the largest possible centrifugal mass must be taken into account.
- The VB S complies with the safety-relevant EMC Regulations (see 14.2 EMC information). In the event of interference levels greater than the limits unsafe operating conditions may occur.
- Even if the motor is stopped and the motor standstill message indicates a motor standstill, the device terminals 2T1, 4T2 and 6T3 as well as all connected cables and motor terminals are not galvanically isolated from the mains voltage.
For all work on the motor circuit and on the associated wiring, the VB S must be disconnected from the mains voltage with a revision switch, motor protection switch or similar disconnecting elements.
- Strong electromagnetic fields can occur in the area near to machines and appliances in which these devices are installed. This could possible affect the operation of active implantations (e.g. heart pacemakers or defibrillators).

The PETER electronic company GmbH & Co. KG does not assume any responsibility for effects of the designated points.

2. Conformity

The described appliances were developed to take over safety functions as part of a whole installation or machine. A complete safety-related system generally contains several components and concepts for safe shutdowns. It is the responsibility of the manufacturer of a machine or appliance to ensure the correct overall function. PETER is not able to guarantee all characteristics of a complete appliance or machine not designed by PETER.

The agreement of the construction of the user with the existing legal provisions is in the area of responsibility of the user.

Operational start-up is prohibited until the conformity of the finished product with the Directives 2006/42/EG (Machine Directive) and 2006/95/EG (Low-Voltage Directive) has been determined.

3. General description

The appliances of the Type VersiBrake Safe (PL c) enable the shutdown of alternating current motors of efficiency classes IE1 to IE3 (IE4 in preparation). Appliances of the type VersiBrake Safe are used for drives that must be reliably shut down for safety-technical and/or economic reasons.

No additional brake protection is necessary if the VersiBrake Safe is used. After the start-up sequence is completed (bridged -> open -> bridged) at the start input of the braking device, the braking phase starts. It is not possible to switch on the motor protection on the VersiBrake safe during the braking phase due to the locking contact den. A regulated direct current is fed into the motor which generates a standing magnetic field and thus a braking moment. An integrated analysis circuit recognises when the motor is standing still. The braking current is then shut off and the standing status is communicated outside via a monitored, positively driven relay contact.

If the start/stop contact is open, the braking phase begins. A controlled direct current is injected into the motor, which generates a standing field, and thus a braking torque. An integrated evaluator identifies the motor standstill. The braking current is then switched off and the standstill is transferred externally over a monitored, positively-driven relay contact.

If no motor standstill is identified within a fixed monitoring time, the braking current is switched off and the motor standstill issued only after a safety time of 300 sec. (coast to stop time with largest flywheel) over the secure, positively-driven standstill signal contact. The user has to ensure that the unbraked coast to stop of his drive (with largest flywheel) is not longer than 300 sec.

With connection of the mains voltage, the device initiates a test braking which checks the device functions. If the start/stop input is activated during test braking, the signal relay output "Combined fault" opens and then the red LED flashes. After performed test braking, the contact closes again. The device is capable of optimising the braking time within 3 starts. The optimal braking time is assumed to be <10s.

So that the relevant specifications of DIN EN 12750:2013 (Safety of Wood Processing Machines) are fulfilled, the following functions are in the device:

- Prevention of an unexpected, fault-dependent starting
- Monitored, controlled stop to standstill
- Secure control of a safety gate
- Motor standstill monitoring

structured in agreement with the requirements of Category 2, PL c from EN13849-1:2008, as well as SIL1 to DIN EN 61508.

The VersiBrake Safe recognises a great variety of faults. All faults which do not allow a secure motor operation any longer cause a switch-on interlocking and are simultaneously output over the monitored, positively-driven relay contact "Device Fault". Device faults can be reset only by a disconnection of the control voltage.

Faults which are not safety-relevant are output over the signalling contact "Combined Fault". Combined faults can be reset over the input "Fault reset".

Over a CAN interface with CAN-Open protocol, device parameters and signals can be exchanged with a higher-level control.

4. Utilisation according to specification

The devices of the Series VB S are electrical operating resources for employment in industrial power installations. They are designed for employment in machines for the reduction of the switch-on torque, for the reduction of the start current peaks, as well as for the slow down of centrifugal masses in case of drives with three-phase motors of the efficiency classes IE1 to IE3 (IE4 under preparation).

Preferred areas of application

- Vibrator
- Wood processing machines
- Centrifuges
- Drives with large centrifugal masses
- Belt drives

4.1 Foreseeable incorrect usages

The appliances of the series VB S may not be used for the following applications:

- For the function of a stopping brake (permanent brake).
 - for braking alternating current motors with an oscillating weight with a stopping time exceeding 25s.
 - to operate alternating current motors with an oscillating weight with an unbraked run-down time exceeding 300s.
 - for operation on a supply network generated by a static transformer, (frequency transformer).
-

5. EU Declaration of Conformity

EU Declaration of Conformity

The manufacturer / marketing agency
(authorised agent of the manufacturer / marketing agency established in the community)

Name / Address: PETER electronic GmbH & Co. KG
Bruckäcker 9
92348 Berg

herewith declares that the following product (device, component, component part), in the implementation as supplied,

Product designation: **Braking Device**
Series / Type designation: VB S ... - 72/ - 132/ - 222/ - 360
Article number: 2B500...
Year of construction: 2018

corresponds to the determinations in accordance with EU Directive:

- | | |
|-------------------|---|
| 2014/30/EU | over the electromagnetic compatibility |
| 2014/35/EU | concerning electric operating resources for utilisation within certain voltage threshold limits |
| 2011/65/EU | for the limitation of the utilisation of certain hazardous materials in electrical and electronic devices |

The following harmonised standards were employed:

- | | |
|--------------------------------|---|
| EN 60947-1:2007+A1:2012 | Low-voltage switching devices
General stipulations |
| EN 60947-4-2:2012 | Low-voltage switching devices
Contactors and motor starters - semi-conductor motor control units
and starters for AC voltages |

This product has been designed as a Class A device. Use in Class B environments (such as residential areas) may cause radio interference. In case of malfunctions, appropriate measures are to be taken.

This EC Declaration of Conformity loses its validity if the product is altered or changed without approval. The undersigned bears sole responsibility for the presentation of this declaration.

Berg, 16.05.2019 Dr. Thomas Stiller, Managing Director
(Location, Date) (Undersigned and function of the undersigned)

(Signature)

6. Declaration related to functional safety



Declaration related to the functional safety

The manufacturer / marketing agency

Name / Address: Peter Electronic GmbH & Co.KG
Brückäcker 9
92348 Berg

herewith declares that the following product (device, component, component part), in the implementation as supplied,

Product designation:	Motor start-braking combination
Series / Type designation:	VB S ... - 72/ - 132/ - 222/ - 360
Article number:	2B500...
Year of construction	2018

Was developed for compliance with the specifications SIL1 and PLc according to the following standards

DIN EN 13849-1:2008	Safety of machines - safety-related parts of controls Part 1 : General structuring directives
DIN EN 13849-1/A1	Safety of machines - safety-related parts of controls Part 1 : General structuring directives - change 1
DIN EN 13849-2:2012	Safety of machines - Safety-related parts of controls Part 2 : Validation
DIN EN 61508-1:2010	Functional safety-related electrical/ electronic/ programmable electronic systems Part 1 : General requirements
DIN EN 61508-2:2010	Functional safety-related electrical/ electronic/ programmable electronic systems Part 2 : Requirements on safety-related electrical/ electronic/ programmable electronic systems
DIN EN 61508-3:2010	Functional safety-related electrical/ electronic/ programmable electronic systems Part 3 : Requirements on software
DIN EN 61508-7:2010	Functional safety-related electrical/ electronic/ programmable electronic systems Part 7 : Overview of processes and measures
DIN EN 62061:2005 + A1:2013	Safety of machines - functional safety-related electrical, electronic and programmable electronic control systems

This declaration loses its validity if the product is altered or changed without approval.

Berg, 30.07.2018 (Location, Date) Dr. Thomas Stiller, Managing Director
(Undersigned and function of the undersigned)

7. Block diagram

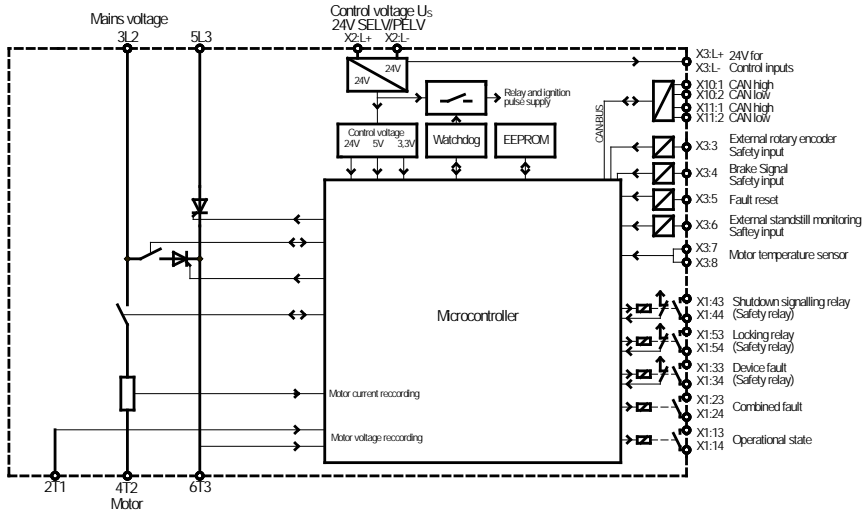

8. Commissioning



Installation notice

Electro-technical specialist knowledge is required for installation and commissioning.

The operational start-up is implemented in 4 steps:

1. Installation see chapter 8.1 Installation information
2. Connection and see chapter 8.2 Connection
3. Parameter setting see chapter 8.3 Parameter adjustments
4. Test of safety function

Commissioning must end with a test of the efficiency of the safety functions!

It must be absolutely ensured that no-one is in the safety zone of the machine or near the drive motors.

- if the motor is switched off, a braking must be initiated and by the third braking at the latest, the motor must come to a complete standstill within 8s.
- From the start of the motor to the standstill of the motor after braking (rotating motor) the MS-output contact X1:43 - X1:44 must be open. If a protective door is attached to this contact, this must be closed and locked if the motor is turning.
- if the motor spins down if the mains voltage is closed off after a certain rotational speed is reached, the closed protective door must remain closed and locked with the applied 24V control voltage must.
- the running-down motor must come to a complete halt with its greatest possible oscillating weight muss within 300s from the nominal rotational speed.



Warning note

Consider the maximum admissible starting and braking currents (see Technical Data on Page 48)

8.1 Installation information



Attention: Electric shocks can be fatal!

The following conditions are to be adhered to for a proper operation of the VersiBrake Safe:

1. The VB S is to be used under overvoltage conditions of Category III.
2. The device may be used only in an environment with degree of pollution 2 or better, in accordance with DIN EN 60644-1/IEC664.
3. The device is to be installed in a housing (protection type at least IP54). Attention is to be paid that the waste heat generated by the braking device can be removed via the housing.
4. The device must be operated free from contamination by water, oil, carbon, dust etc.
5. With the connection of the devices of construction size 1 (72A, 132A, 222A), it is to be noted that the network and motor lines are stripped of insulation for 18 mm and, in case of construction size 2 (360A), stripped of insulation for 15 mm. If lines are stripped of insulation too short, or with too short end sleeves and are used for the connection, this leads to a high contact resistance and to ultimate destruction.

Set the device vertically on a vertical installation surface. The motor terminals are to be mounted below. The installation is implemented by screwed connection of the four fastening plates. The devices can be set in a row near each other without separation distance. If the devices are arranged above each other, a separation distance of 100 mm must be kept between the heatsinks. No additional large heat sources may be arranged below the devices, such as e.g. devices with high power dissipation, heat resistors or similar.

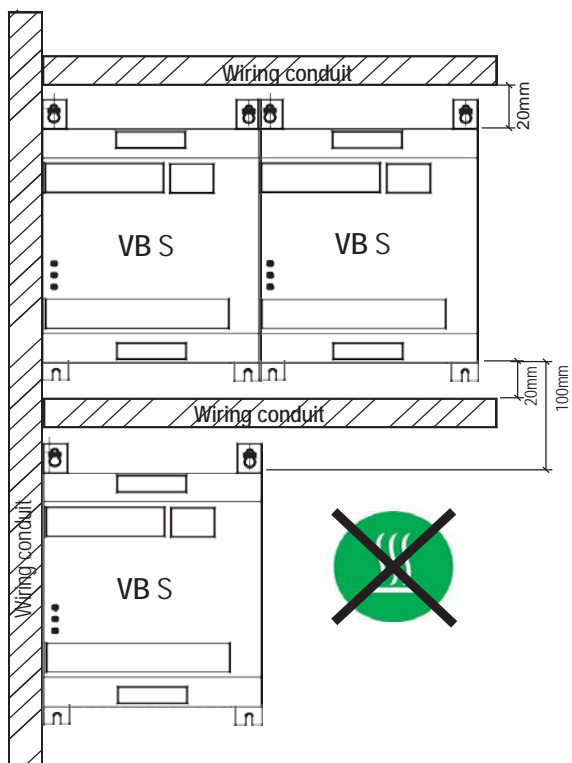
**Warning note**

For the avoidance of heat backups, a separation distance of at least 20 mm is to be kept between wiring system conduit and device.

8.2 Connection

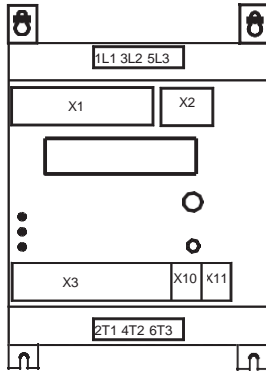

Power module (see also terminal diagram)

- | | |
|---|---------------------|
| Terminal 1 L1: | Mains voltage L1 |
| Terminal 3L2: | Mains voltage L2 |
| Terminal 5L3: | Mains voltage L3 |
| Grounding connection  PE | |
| Terminal 2T1: | Motor connection T1 |
| Terminal 4T2: | Motor connection T2 |
| Terminal 6T3: | Motor connection T3 |



Attention!
In case of the connection of the mains and motor cables for the construction size 1, strip these of insulation at least 18 mm and, for the construction size 2, strip these of insulation at least 15 mm!
Torque for construction size 2: 3 ... 3,5Nm (26,6 ... 31 lbs-in)

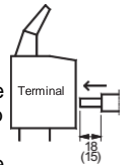

Control part

Control outputs - terminal block X1

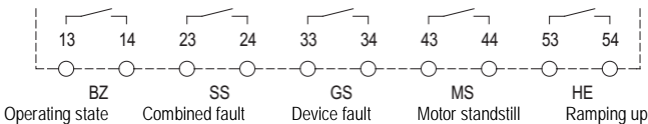

With the output contacts, it involves relay contacts 250VAC/4A; 30VDC/4A

Control voltage U_s - terminal block X2

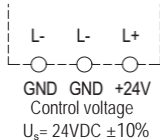

An external control voltage U_s of 24VDC ±10% is connected to the terminals L+, L-.

Control inputs - terminal block X3

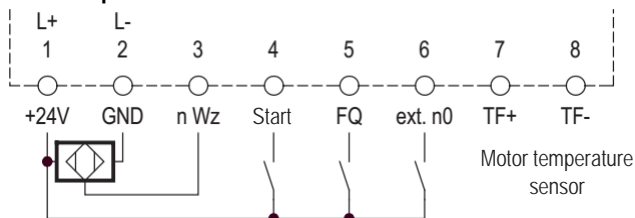

The input impedance of the control inputs is 5 kOhm. Switch contacts, which can securely switch the lower control currents (4.8mA), must be used for the control activation!

The terminal X3:1 (L+) is connected internally with the terminal X2:L+.

The terminal X3:2 (L-) is connected internally with the terminal X2:L-.

The input terminals X3:3 to X3:6 are control-activated with the L+ potential.

X3:3 -n tool . recording of the tool rotational speed

X3:4 -Start-Start sequence bridged -> open -> bridged

X3:5 -FQ- reset of the combined fault 24 V - reset of fault.

X3:6 -ext. n0-external standstill monitoring. 24 V - motor standstill identified.

The motor temperature monitoring is connected to the terminals X3:7 and X3:8 (TF+ and TF-).

- Thermo-switch (open = over-temperature)
- Motor PTC
- Motor KTY84 (case of utilisation of a KTY, the motor temperature can be scanned over CAN bus or LCD operator panel).
- Motor PT1000 (case of utilisation of a PT1000, the motor temperature can be scanned over CAN bus or LCD operator panel).

CAN sockets X10, X11 (RJ45)

1 = CAN H

2 = CAN H

3 = GND



Attention! Electric shocks can be fatal!

Even if the motor stops, it is **not** isolated galvanically from the network.

8.3 Parameter adjustments

The devices are delivered with a default parameter set.

Motors with a power rating which is in the range of the motor power rating are adjusted to an optimal braking time after a maximum of 3 braking operations.

The default value for the braking time is 8 sec.



If a parameter adaptation is necessary, this can be carried out over CAN bus or the LC display panel with rotation selection key, according to the parameter list.

8.4 LCD operator panel / menu language

The menu language can be changed through pressing the button and holding it pressed. After approx. 5 sec, the display changes into the Selection mode and the required language can be adjusted with the rotating encoder. The adjusted language is confirmed with the button and the display changes into the selected language.

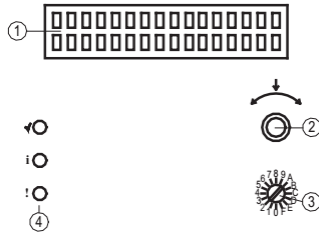
The devices are equipped with a two-line LC display to display the states and programming modes, as well as with a rotating encoder pushbutton function to control and data input.



1	two-line display for operating states, parameters and programming
2	<p>Rotation encoder with pushbutton function for navigation in the menus and data input</p> <p>Scrolling in the menus and value input</p> <p>Pushbutton actuation:</p> <p> 1. short press -</p> <p style="margin-left: 20px;">A.) Main menu: Call-up of a menu, sub-menu, parameter group or parameter level</p> <p style="margin-left: 20px;">B.) Parameter level: Leaving the parameter level and skipping back into the parameter groups</p> <p style="margin-left: 20px;">C.) Programming mode: Call-up of a program parameter group and program parameter level. Confirm change mode or value selection.</p> <p> 2. long press (>1s) -</p> <p style="margin-left: 20px;">A.) Status menu: Skipping back into the main menu and display of operating state</p> <p style="margin-left: 20px;">B.) Programming mode: Saving the parameter value or leaving the change mode or skipping back into the higher-level menu.</p>
3	CAN - bus address selection switch
4	<p>3 LED's for the status display</p> <p>● LED green - device ready to operate</p> <p>i LED yellow – off</p> <p>! LED red - Continuous lighting</p> <p>Flashes</p> <p style="margin-left: 20px;">- Operating state "Standby"</p> <p style="margin-left: 20px;">- Operating state "Braking"</p> <p style="margin-left: 20px;">- Operating state "Bypass"</p> <p style="margin-left: 20px;">- Device fault</p> <p style="margin-left: 20px;">- Combined fault</p>

The LCD display has a back lighting with a standard lighting duration of 30 sec. The lighting duration can be changed under the system parameters in the programming mode. If the rotating encoder or button becomes activated, the back lighting switches on.

8.4.1 Display / Operation

8.4.1.1 Display

In the operator panel, a wide range of operating modes of the braking device are displayed.

After the switching on of the mains power supply, as well as the control voltage, the device is initialised and a test braking then carried out. If the test braking has been completed successfully, the device changes into the operating state "Standby" and the device status appears in the display.

Standby	Remote	-- Operating mode: control via control terminals
Standstill	OK	-- Motor standstill identified (status indicator line)



In the status indicator line, different operating values can optionally be displayed. The selection is implemented with the parameter "Status display main menu" in the system parameters. The following options are available for selection:



Standstill OK

- 1 Braking current
- 2 Motor voltage
- 3 Mains voltage
- 4 Device operating status
- 5 Device temperature
- 6 Thermal device image
- 7 Heat sink temperature
- 8 Motor temperature

8.4.1.2 Operation





The device is operated with the rotating encoder placed on the front side with pushbutton function.

-  Rotating encoder right / left
-  Press rotating encoder shortly / for a long duration (long >= 1s)

As a result of right-hand or left-hand turning of the rotating encoder () , scrolling in the main menu takes place. After selection of a menu, the rotating encoder is pressed shortly () , a branch-out into the corresponding sub-menu occurs.

Menu selection and change of the parameter values are controlled over the rotating encoder. With actuation of the button, a skip is made into the next menu level or a selected level is left.

If no actuation is implemented for 20 sec in the status Parameter mode or 60 sec in the Programming mode, the display returns to the standby operating state. On leaving the Programming mode, the values are saved on request only.

With the rotating encoder () , scrolling can be now be implemented through the submenus. If a submenu is selected, by short pressing of the button () a skip is made into the parameter group. By rotating the rotating encoder () , scrolling can be implemented between the parameter groups. If a group has been selected and the button pressed shortly () , a change is made into the parameter level. Here, a selection can be made () between the individual parameters of a group by turning the rotating encoder. In the display, the corresponding

parameter value is displayed. The parameter values can be changed here in the Programming mode.

A return to the group level is achieved by short pressing of the button  alternately or through long pressing of the button in the Standby mode.

In operating mode "Motor running" or during the rundown of the safety time period, a change can be made to the status parameter menu or into the Programming mode. As a result of long pressing  during running motor or during the safety time period, a change is made into the main menu. The menu groups Status parameter and Programming mode can now be selected between.



A. Status parameter:

All device parameters, subdivided into groups, are displayed (see Table 8.4.1.1):

- A.1 Device data
- A.2 Motor data
- A.3 Brake parameter
- A.4 System parameter
- A.5 Operating data
- A.6 Status messages
 - A.6.1 Combined fault
 - A.6.2 Devices fault
 - A.6.3 Device status

B. Programming mode:

In the programming menu all adjustable parameters can be displayed and changed (see Chapter 8.4.3) with which the VersiBrake Safe is controlled.

In order to open the programming menu, a password must first be entered () and confirmed (). The programming menu is subdivided into the following groups:

- B.1 Motor data
- B.2 Brake parameter
- B.3 System parameter
- B.4 CAN parameter
- B.5 Expert mode
 - B.5.1 Brake parameter
 - B.5.2 System parameter
 - B.5.3 Factory reset

8.4.1.1 Description of the display texts in the status parameter menu

Display	Description
A.1 Device data	
Rated Device-Voltage V	Device voltage
Rated Device -Current A	Device rated current
Warning temperat Device °C	Device warning temperature
CAN-Bus Baudrate kB	speed of the CAN bus (trasfer rate)
CANopen Node ID	current address setting CANopen Node ID
CANopen Node ID Base	current CANopen Node ID basis
CANopen Node ID Offset	current CANopen Node ID offset
CANopen Heartbeat	current CANopen heartbeat
A.2 Motor data	
Rated Motor-Current A	In factory settings or factory reset, the motor nominal current corresponds to the lowest recommended motor power for the respective appliance size at 400V mains voltage, see chapter 15 "Technical Data". The maximum motor nominal current corresponds to the recommended max. motor power for the respective appliance size die at 400V mains voltage, see chapter 15 "Technical Data".
Rated Motor-Voltage V	current motor voltage.

A.3 Brake parameter	
BrakeMode 0=SO 1=SwO 2=t 3=PW	Selection of the braking mode as the motor is stops. 0 = SO -> Standstill-dependent braking with braking time optimisation 1 = SwO -> Standstill-dependent braking without braking time optimisation 2 = t -> Time-dependent braking 3 = PA -> Braking with fixed phase angle, see parameter 4801
Motor Braking Time ms	- At BrakeMode 0 "Standstill-dependent braking with braking time optimisation" - the value is the setpoint for braking time optimization.. - At BrakeMode 2 "Time-dependent braking" - the value correspond to the braking time. See Parameter BrakeMode 4003.
Set Point Brake Current A	The setpoint value of the braking current at BrakeMode 0, 1 or 2, see parameter selection 4003.
Minimal Braking Current A	Minimum possible braking current at BrakeMode 0, see selection parameter 4003. The braking current is not controlled below this minimum value. Thus a deceleration of the motor is ensured.
Monitoring Time Int.Brake ms	Monitoring of the braking time with internal standstill monitoring unit. The standstill must be dedected within this time. Only in case of BrakeMode 0 or 1, see parameter selection 4003.
Max Second Brake Time ms	Post-braking time after motor standstill is dedected only with braking type 0 or 1, see parameter selection 4003.
Selection Brake Termination	Activation or deactivation of the braking interruption, in order to perform a new motor start during a braking period, or to end the braking sequence completely before a new start is performed. 0 = No start during braking possible: Brake period will be finished before a new start is performed. 1 = Start during braking possible: Braking is interrupted, new start is possible immediately.
Comb.Fault 3x No Standstill	Combined fault triggered if no standstill identified 3x. 0 = inactive 1 = active
Ext. Standstill Monitor	Standstill recognition with external standstill monitoring unit. 0 = External standstill monitoring unit inactive 1 = External standstill monitoring unit active
Monitoring Time Ext.brake ms	Monitoring of the braking time with external standstill monitoring unit. The standstill must be identified within this time. Effective only in case of external standstill monitoring unit CAN Parameter 4004.
Ext. Standstill Signal ms	Monitoring of the external standstill signal after disconnection of the braking current. Effective only in case of external standstill monitoring unit CAN Parameter 4004.
Test Braking Delay ms	In case of several devices in a system, the test braking is triggered with a delay time. Delay time = Deceleration test braking x (switch position on the CAN address selection switch - 1) 0 = 0;
Debounce Time Brake Relay ms	Duration of the bounce time of the braking relay. Close time period between braking relays and control activation of the braking current.
I-Amplification Brake	I-Proportional brake current regulation. Is only active in brake modes 0, 1 and 2 see parameter 0x4003
P-Amplification Brake	P-Proportional brake current regulation. Is only active in brake modes 0, 1 and 2 see parameter 0x4003
Current Low Lim. Brake %	In braking operation, an device fault is caused after the measuring time and undershooting the current lower limit.
Monitor. Current Low Limit ms	Measuring time of the current lower limit in braking operation after which an device fault is triggered.
Current Hi Limit Brake A	In braking operation an device fault is triggered after expiry of the measuring time and exceeding the current upper limit.

Display	Description
Monitor. Current Hi Limit ms	Measuring time of the current upper limit in braking operation after which an device fault is triggered.
Mode Delay Time Brake	With this parameter, the mode of delay time (VZA) between motor release and control activation of the braking current is selected. 0 = Delay self-optimising 1 = Fixed delay time 2 = Delay time motor voltage-dependent
Delay Time Brake ms	Delay between motor release and activation of the braking current at Mode Delay time 1 "fixed delay", see parameter 4017.
Threshold Motor Voltage mV	Limit value of the motor voltage at Mode Delay time 2 "motor voltage-dependent", see parameter 4017.
Detect. Standst. Delta t ms	Time (dt) of the current rise in case motor standstill dedected by braking current form. When BrakeMode 0 or 1 is selected"Standstill-dependent braking ...", see parameter BrakeMode 4003.
Detect. Standst. Delta I mA	Level (di) of the current rise in case motor standstill dedected by braking current form. When BrakeMode 0 or 1 is selected"Standstill-dependent braking ...", see parameter BrakeMode 4003.
Standstill Incr. Delta-t ms	Time period (dt) of the voltage rise with standstill recognition through remanence voltage.
Standstill Incr. Delta-U mV	Level (du) of the voltage rise with standstill recognition through remanence voltage.
Standstill OV Delta t ms	Time period (dt) of the 0-line undershooting with standstill recognition through remanence voltage.
U-Remanence Cons Delta t ms	Time (dt) in which the remanence voltage must remain constant after motor standstill.
U-Remanence Cons Window mV	Threshold value (u) minimum voltage in which the standstill identification works through remanence voltage.
Toler. Remanence Voltage mV	Permissible voltage tolerance of the standstill recognition through remanence voltage.
U-Rem Values Out Of Tolerance	Number of values which may not be in the permissible tolerance of the standstill recognition through remanence voltage. *
Threshold Motor Standst. mV	Threshold value for the identification of the voltage standstill recognition. A change affects the identification of the motor standstill. This parameter may be changed only in discussion with PE. *
Currentless Time Stdstill ms	Tolerance t for the identification of the currentless standstill. *
Currentless Volt Stdstill mV	Tolerance U for the identification of the currentless standstill. *
Stdstill Delta I Const. t ms	delta t for the identification of the current standstill in case of still rotating motor. *
Stdstill Delta I Const. I	delta i for the identification of the current standstill with motor still rotating. *
Threshold Motor Standst. mV	Threshold value for the identification of the voltage standstill with already motor standstill. *
Sensitivity Curr Standstill	Sensitivity current standstill.*
Remanence Volt. Standst. OV	Assessment remanence voltage standstill On/Off.*
Phase Angle Brake	Fixed phase angle. PE internal

Display	Description
A.4 System parameter	
Selection Star - delta-start-up	Activation of the function star-delta-start-up (collective fault relay = star contactor relay; operation status relay = delta contactor relay) 0 = Star-delta start-up deactivated 1 = Star-delta start-up activated
Star contactor on-time ms	Switch-on time for the star contactor with activated start-delta start-up function see parameter 0x4200.
Switch delay star-delta ms	Switch delay between star and delta contactor with activated star-delta start-up function see parameter 0x4200.
Warning Temperature Device °C	If the device temperature reaches the adjusted value, a warning is issued. (default 70°)
Temperat. Sensor Motor	Type of the motor temperature sensor (PTC/KTY84/Switch) or calculation of the thermal motor image. 0 = PTC 1 = KTY84 2 = switch 3 = PT1000 (default)
Motor Warning Temperature °C	If the motor temperature reaches the adjusted value, a warning is issued. Only active with KTY and PT1000 and motor protection
Trip Temperature Motor °C	If the motor temperature reaches the adjusted value, a Combined fault issued. Only active with KTY and PT1000 and motor protection (default 155°)
Re-Start Temper. Motor °C	If the motor temperature falls below the re-start temperature, the "Motor over-temperature combined fault" can then be reset. Only active with KTY and PT1000 and motor protection (default 130°)
Deactiv. Motor Protection	Temperature monitoring of the motor is deactivated. The adjustment in CAN Parameter 0x4012 is ineffective with that. 0 = Motor protection active (default) 1 = Motor protection inactive
Ext. Tool Speed Sensor	Activation of the external recording of the tool speed. 0 = Tool speed not recorded (default setting) 1 = Tool speed recorded Tool rotational speed can only be recorded if parameter 0x4030 "Select brake cancellation" is not active.
Minimum External ToolSpeed	If the tool speed falls below the minimum tool speed, a combined fault is triggered.
Monitoring Time ToolSpeed ms	Measuring time in which no pulse of the tool pulse generator should be recorded. Standstill identification.
Ext. Tool Speed Tolerance %	If the tool speed decreases in bypass status and falls below the tool speed tolerance, a combined fault is triggered. (Belt break identification)
Options Operating State Relay	Assignments of the operating states which are displayed on the BZ signal relay. (default 464, binary coded: 111010000) 0 = Status is not displayed 1 = status is displayed
Options Combined Fault Relay	The assignment of the combined faults which are displayed with the SS signal relay. (Default setting 2047, binary coded:1111111111) 0 = fault is not displayed 1 = fault is displayed
Mains Switch-Off Voltage V	Minimum mains voltage level in the 3 phases, which is identified as a switch-off threshold of the mains voltage. After the expiry of the network measuring time disconnection, Parameter 4501, a combined fault is triggered.
Monitoring Mains Switch-Off ms	Measuring time of the network disconnection up to the activation of a combined fault.
U-Mains Low Trip Value V	Lower tolerance limit of the mains voltage. After the expiration of the acquisition time an device fault is triggered.
Light Period LC-Display s	Lighting period of the LCD background lighting. (default 30s)
Status Display Main menu	Display value in the status display line in the main menu. The current values of the selected parameter are displayed.
Language	German, English

Display	Description
A.5 Operating data	
Actual Starts Total	Actual sum of the implemented starts
Act. Brake Time Total s	Actual sum of the accumulated braking times
Motor time active sum s	Current total of the cumulative time with the motor running.
Act.Standby Time Total s	Actual sum of the accumulated time in standby operation.
Act.Operat. Time Total s	Actual sum of the accumulated operating time
Braking Current Act. value A	Actual braking current.
Max Braking Current Act. value A	Peak value of the braking current.
Actual Motor Voltage V	Currently measured motor voltage
Max. Motor Temp. X YY	Actual motor temperature According to selected temperature sensor X, the display value corresponds to YY: - PTC = Resistance value of the temperature sensor in the motor in ohm - KTY84 = °C - Switch = Voltage at the measurement input in mV - PT1000 (default) = °C - No motor temperature sensor selected = 0
Actual Device Temperature °C	Actual device temperature
Thermal Model Device %	Actual thermal device image in %
Actual Heatsink Temperature R	Actual resistance value of the heatsink temperature sensor (PTC)
Actual Control Voltage V	internal control voltage
Mains Voltage L2 – L3 V	Actual voltage on L2 – L3
EEPROM - Data Read Values	change to the submenu A.5.1

Display	Description
A5.1 EEPROM data	
Number Starts Total	Sum of the implemented starts
Braking Time Total s	Sum of the accumulated braking times
Motor time active sum s	Current total of the cumulative time with the motor running.
Standby Time Total s	Sum of the accumulated time in standby.
Operating Time Total s	Entire operating time of the device
Max Braking Current Act. value A	Peak value of the braking current.
Max. Mains Voltage V	Highest measured mains voltage
Max. Motor Voltage V	Highest measured motor voltage
Max. Braking Time s	longest measured braking time



Display	Description
Maximal Device Temperature °C	Highest measured device temperature
Max. Heatsink Temperat. R	Highest measured heatsink temperature. The display value is the resistance value of the temperature sensor (PTC resistance) on the heatsink.
Max. Motor Temp. X Y	Highest measured motor temperature. According to selected temperature sensor X, the display value corresponds to YY: - PTC = Resistance value of the temperature sensor in the motor in ohm - KTY84 = °C - Switch = Voltage at the measurement input in mV - PT1000 (default) = °C - Thermal motor representation = buffer in %
Device Fault Memory1	Indicates the content of the fault storage "memory position 1" in the decimal format. By decoding in the binary format, recoding can be implemented on the stored combined faults: 0 = no fault 1 = fault occurred bit 0 = Not assigned 1 = Not assigned 2 = Not assigned 3 = Not assigned 4 = Free-wheeling arm short-circuit 5 = Test braking failed (motor voltage) 6 = Test braking failed (motor current) 7 = Not assigned 9 = Ignition fault braking circuit thyristor 10 = Interruption in the free-wheeling arm 11 = Operating state not defined 12 = Not assigned 13 = Control input defective 14 = Control output relay defective 15 = No motor current 16 = Motor overload 17 = Internal device error 18 = Internal EEPROM memory error 19 = Not assigned 20 = Not assigned 21 = Not assigned 22 = Short circuit mains-motor side or motor circuit open 23 = Motor voltage recording defective or motor circuit open
Device Fault Memory2	Indicates the content of the fault storage "memory position 2" in the decimal format. See device fault save Pos.1.
Device Fault Memory3	Indicates the content of the fault storage "memory position 3" in the decimal format. See device fault save Pos.1.
Device Fault Memory4	Indicates the content of the fault storage "memory position 4" in the decimal format. See device fault save Pos.1.
Device Fault Memory5	Indicates the content of the fault storage "memory position 5" in the decimal format. See device fault save Pos.1.
Combined Fault Memory1	Indicates the content of the fault storage "memory position 1" in the decimal format. By decoding in the binary format, recoding can be implemented on the stored combined faults: 0 = No fault 1 = Fault has occurred bit 0 = Not assigned 1 = Not assigned 2 = Tool rotational speed deviates from setpoint speed 3 = Motor over-temperature 4 = Braking time optimisation not possible 5 = Mains phase failure / Mains voltage outside tolerance 6 = Heatsink temperature 7 = Maximum braking time exceeded 8 = Maximum device over-temperature exceeded 9 = Start contact not connected

Display	Description
Combined Fault Memory2	Indicates the content of the fault storage "memory position 2" in decimal format. See combined fault save Pos.1.
Combined Fault Memory3	Indicates the content of the fault storage "memory position 3" in the decimal format. See combined fault save Pos.1.
Combined Fault Memory4	Indicates the content of the fault storage "memory position 4" in the decimal format. See combined fault save Pos.1.
Combined Fault Memory5	Indicates the content of the fault storage "memory position 5" in the decimal format. See combined fault save Pos.1.











Display	Description
A.6 Status Messages	
A.6.1 Combined fault	
n.r.	Not assigned
n.r.	Not assigned
Tool Speed	Tool speed deviating from the setpoint speed.
Max. Totor Temp.	Maximum permissible motor overtemperature exceeded.
3x No Stillstand	Brake time optimization not possible.
Power Fail L2 L3	Mains supply failure in phases L2, L3.
Max Heatsink Tmp	Maximum permissible heat sink overtemperature exceeded.
Max Braking Time	Maximum braking time exceeded.
Max.Device Temp.	maximum device temperature of the thermal simulation exceeded.
StartContactopen	The start input is open or no NC contact of the motor contactor is connected to the start input.
Motor Rating	During test braking, the braking current exceeds the Max. Device brake current i.e. Connected motor too big.
A.6.2 Devices fault	
n.r.	Not assigned
n.r.	Not assigned
n.r.	Not assigned
n.r.	Not assigned
Zero-Cross L2-L3	Short circuit in the freewheeling branch.
Motor Voltage	Test braking failed (motor voltage).
CurrentAutoTuning	Test braking failed (motor current).
n.r.	Not assigned
RAMTEST error	Internal memory error.
Curr. Dir. Brake	Wrong polarity of the braking current at the beginning of braking.
Freewheel. Fault	Interruption in the freewheel branch.
Undef. Condition	Undefined operating state.
n.r.	Not assigned
Diagnosis Input	Control input defective.
Diagnosis Output	Control output relay defective.
Under Current	No motor current
Over Current	Motor overloaded.
Device Data	Internal device error (electronics, components, ...)
EEPROM Diagnosis	Internal EEPROM memory error.
n.r.	Not assigned
n.r.	Not assigned
n.r.	Not assigned
Fault Zero-Cross	Short circuit between the mains and motor side, or motor circuit open.
Fault MotorVolt.	Motor circuit open or motor voltage detection defective.

A.6.3 Device Status	
No Mains Voltage	No mains voltage connected
Warning Temp Mot	Motor warning temperature exceeded
Warning Temp Dev	Device warning temperature exceeded
Tool Speed	Tool speed detected with external sensor
BZ-Relay Closed	BZ relay (operating state) closed
SS-Relay Closed	SS relay (collective fault) closed
GS-Relay Closed	GS relay (device fault) closed
MS_Relay Closed	MS relay (motor standstill) closed
SD-Relay Closed	SD relay (star-delta) closed
Hardware Detect	Evaluation hardware status internally
Network Qual	No braking possible due to power quality
BrTesting Data	Test data is sent (for internal purposes only)
SRS second Brake	Standstill remanence voltage constant after-brake flag (Only at P50_0A)
SRS Currentless	Standstill remanence voltage was detected
SRS I-Increase	Standstill remanence voltage increase has been detected
SRS - 0-Voltage	Standstill remanence voltage 0V was detected
EEPROM-DATASAFE	Data was stored in the EEPROM. (Only at 24 V elimination)
Start End Relay	Status diagnostic HE-relay
Standstill Relay	Status diagnostic STS-relay
Diag. Device Err	Status diagnostic GS-relay
Extern. Speed A1	Status External speed input - Channel A
Extern. Speed B1	Status External speed input - Channel B
Ext. Standst. A1	Status of external standstill monitor input - Channel A
Ext. Standst. B1	Status of external standstill monitor input - Channel B
Start/Stop A ON	Status start / stop input - Channel A
Start/Stop B ON	Status start / stop input - Channel B
SRS Constant	Standstill remanence voltage constant was detected
No Standstill	No standstill detected during the monitoring period
Standstill OK	Standstill detected during monitoring time
Standst. I-Brake	Standstill brake current was detected
Standst. U-Rema.	Standstill remanence voltage has been detected

8.4.2 Programming mode

In order to open the programming menu, confirm the Programming mode . A password (default "2") must be entered. For this purpose, turn the rotating encoder to the right or left () until the correct password is displayed. Then press the rotation knob shortly () and confirm the password with that.





8.4.2.1 Change of parameter values

Scroll in the programming menu  until the required group is displayed and confirm  with button. Select with  the corresponding parameter and confirm . As a result of short pressing  of the button, a switch is made into the Change mode and the cursor flashes. The selected parameter is shown with its value in the display. Change the value with the rotating encoder  until the setpoint value is reached. As a result of short activating  the button, the cursor changes from the ones digit to the tens digit and the parameter value can then be changed in 10 steps. By further pressing  of the button, the cursor is set to the next digit or reset to the ones digit again. The change mode can be left again through long pressing  the button, the cursor does not flash any longer. The display changes back to the parameter level. Now a further parameter can be selected and changed. For saving the changes or leaving the Change mode, press the button  for a longer time (>1 sec). In the display there appears "Save parameters".

Set the required action

no = Leave without saving

Yes = Save parameter value and leave

by rotating the rotating encoder  in and confirm by short pressing the button . The display changes back into the higher-level menu group which was previously selected. In order to leave the programming menu, select the menu item "Leave Programming mode"  and confirm  briefly or press the button  for a longer time. The display changes back into the main menu or into the Standby mode.



Warning note

If "No" is confirmed at "Save parameters", the parameter menu is then exited without saving the changes.

If the rotating encoder 60s is not activated in the programming mode and/or change mode, then the programming mode is exited without saving. A change is made into the main menu.

8.4.2.2 Expert mode

In order to reach the Expert mode and thus to change the extended parameter set, the input of an additional password is necessary. The change of these parameters presupposes very good system know-how and should be implemented with great caution. The operation and the change of parameters is implemented as described under 8.4.2.1.

8.4.3 Description of the adjustable parameters

8.4.3.1 Motor data

Display	Description	min	max	Default	CAN param.	User adjustments
B.1 Motor data						
Rated Motor Current A	At factory settings or factory reset, the rated motor current corresponds to the lowest recommended motor power for the respective device size at 400V mains voltage, see technical data. The max. adjustable rated motor current corresponds to the recommended max. motor power for the respective device size at 400V mains voltage, see technical data.	0,1* ¹⁾ I _c ²⁾	⁴⁾	⁵⁾	4032	

8.4.3.2 Brake parameter

Display	Description	min	max	Default	CAN param.	User adjustments
B.2 Brake parameter						
BrakeMode 0=SO 1=SWO 2=t 3=PA	Selection of the braking mode as the motor is stops. 0 = SO -> Standstill-dependent braking with braking time optimisation 1 = SwO -> Standstill-dependent braking without braking time optimisation 2 = t -> Time-dependent braking 3 = PA -> Braking with fixed phase angle, see parameter 4801 - At BrakeMode 0 "Standstill-dependent braking with braking time optimisation" - the value is the setpoint for braking time optimization.. - At BrakeMode 2 "Time-dependent braking" - the value correspond to the braking time. See Parameter BrakeMode 4003.	0	3	0	4003	
Motor Braking Time ms		500	40000	8000	3006	
Set Point Brake Current A	The setpoint value of the braking current at BrakeMode 0, 1 or 2, see parameter selection 4003.	$0,15 * I_e^{(2)}$	$I_e^{(2)}$	$2,5 * I_{Mot}^{(1)}$	3005	
Minimal Braking Current A	Minimum possible braking current at BrakeMode 0 or 1, see selection parameter 4003. The braking current is not controlled below this minimum value. Thus a deceleration of the motor is ensured.	$0,10 * I_e^{(2)}$	$0,9 * I_e^{(2)}$	$1,5 * I_{Mot}^{(1)}$	4060	
Monitoring Time Int.Brake ms	Monitoring of the braking time with internal standstill monitoring unit. The standstill must be detected within this time. Only in case of BrakeMode 0 or 1, see parameter selection 4003.	1000	25000	10000	4005	
Max Second Brake Time ms	Post-braking time after motor standstill is detected only with braking type 0 or 1, see parameter selection 4003.	1000	10000	10000	4013	
Selection Brake Termination	Activation or deactivation of the braking interruption, in order to perform a new motor start during a braking period, or to end the braking sequence completely before a new start is performed. 0 = No start during braking possible: Brake period will be finished before a new start is performed. 1 = Start during braking possible: Braking is interrupted, new start is possible immediately.	0	1	0	4030	
Comb.Fault 3x no Standstill	Device fault is triggered when 3x no standstill detected. 0 = inactive 1 = active	0	1	1	4021	
Ext. Standstill Monitor	Standstill detection with external standstill monitor. 0 = inactive 1 = active	0	1	0	4004	
Ext. Brake Time Monitor. ms	Monitoring of the braking time with external standstill monitor. The standstill must be detected within this time. Only with external standstill monitor.	1000	25000	10000	4015	
Ext. Standstill Signal ms	Measuring time of the external standstill signal after switching off the brake current. Only with external standstill monitor.	1000	20000	6000	4031	
Test Braking Delay ms	If there are several devices in a system, the test braking is triggered with a delay time. Delay time = test braking delay * Switch setting on the CAN address selector switch - 1 (0 = 0).	0	20000	3000	4080	

1) I_{Mot} refers to the parameter 0x4032 (B.1)

2) I_e is the maximum device braking current

4) The maximum motor rated current is the rated current of the largest recommended motor power at 400V. For the respective device size see chapter 15 "Technical data"

5) When factory set, the rated motor current will equal the rated current of the lowest recommended motor power at 400V. For the respective device size see chapter 15 "Technical data".

8.4.3.3 System parameter

Display	Description	min	max	Default	CAN param.	User adjustments
B.3 System data						
Option Star - Delta-Start-up	Activation of the star-delta starting function (collective fault relay = star contactor relay, operating status relay = delta contactor relay) 0 = star-delta start deactivated 1 = star-delta start activated	0	1	0	4200	
Star-Contactor On-time ms	Switch-on time for star contactor with activated star-delta start function see parameter 4200.	3000	15000	4000	4201	
Switch Delay StarDelta ms	Switching delay between star and delta contactor with activated star-delta start function, see parameter 4200.	50	500	100	4202	
Device Warning Temperature °C	If the device internal temperature reaches the set value, a warning is issued. (Default 70 °)	40	80	70	4026	
Sensor Motor Temperature	Type of motor temperature sensor (PTC / KTY84 / switch) 0 = PTC 1 = KTY84 2 = switch 3 = PT1000 (default)	0	3	3	4012	
Motor Warning Temperature °C	If the motor temperature reaches the set value, a warning is issued. Only active with KTY and PT1000 and motor protection.	80	190	135	4023	
Trip Temperature Motor °C	If the motor temperature reaches the set value, a group fault is output. Only active with KTY and PT1000 and motor protection. (Default 155 °)	120	200	155	4022	
Re-Start Temp. Motor °C	If the engine temperature falls below the Restart temperature, then the "Common motor overheating error" is acknowledged. Only active with KTY and PT1000 and motor protection. (Default 130 °)	80	160	130	4024	
Deactiv. Motor Protection	Temperature monitoring of the motor is deactivated. The setting in CAN parameter 0x4012 thus becomes ineffective. 0 = motor protection active (default) 1 = motor protection inactive	0	1	0	4033	
External Tool Speed	Activation of the external detection of the tool speed. 0 = tool speed not detected (default) 1 = tool speed detected	0	1	0	4035	

Display	Description	min	max	Default	CAN param.	User adjustments
Min. Tool Speed	If the tool speed falls below the minimum tool speed, a collective fault is triggered.	1	10000	2500	4078	
Monitor Duration Tool Spd ms	Measuring time in which no pulse of the tool pulse generator is to be detected. Detection standstill.	6000	12000	6000	4016	
Tool Speed Tolerance %	If the tool speed falls in the bridged device state and falls below the tool speed tolerance, a collective fault is triggered (belt breakage detection).	50	95	80	4076	
Opts Operating State relay	Assignments of the operating states that are displayed on the BZ signaling relay. (Default 0, binary coded: 010001100100 = 464) 0 = state is not displayed 1 = status is displayed bit 0 = waiting time 1 = determine device data 2 = initialize EEPROM 3 = measure mains frequency 4 = carry out test braking 5 = standby 6 = not used 7 = engine is running 8 = braking 9 = device or collective fault 10 = disturbance of device data 11 = fault EEPROM 12 = test program	0	8191	0	4077	
Options Combined FaultRelay	The assignment of the collective faults that are displayed with the SS signaling relay. (Default 1020, binary coded: 01111111100) 0 = fault is not displayed 1 = fault is displayed bit 0 = not used 1 = not used 2 = tool speed deviates from the setpoint speed 3 = motor overtemperature 4 = braking time optimization not possible 5 = mains phase failure 6 = heat sink overtemperature 7 = maximum braking time exceeded 8 = maximum device overtemperature exceeded 9 = no start contact connected 10 = not used	0	2047	1020	4029	
Light Period LC-Display s	Luminous duration of the LCD backlight. (Default 30s)	5	120	30	3007	
Status Display Main Menu	Selection of the status line in the main menu. The current values of the selected parameter are displayed. 0 = standard display factory setting: Standby => standstill OK; Engine running, brakes => current braking current; 1 = braking current; 2 = motor voltage; 3 = mains voltage; 4 = device operating status; 5 = internal device temperature; 6 = thermal device image; 7 = heat sink temperature; 8 = motor temperature (PTC, KTY84, thermal switch, PT1000)	0	8	0	3014	
Language	Selection of display language: 0 = German 1 = english	0	1	0	3010	

8.4.3.4 CAN Parameters

Display	Description	min	max	Default	CAN param.	User adjustments
B.4 CAN parameter						
CAN-open Baudrate kB	Speed of the CAN-Bus (transmission rate)	0	1000	125	4037	
CAN-open Node ID Adresse 0	Address setting CANOpen Node ID 0	1	127	57	4036	
CAN-open Node ID Adresse 1	Address setting CANOpen Node ID 1	1	127	58	4044	
CAN-open Node ID Adresse 2	Address setting CANOpen Node ID 2	1	127	59	4045	
CAN-open Node ID Adresse 3	Address setting CANOpen Node ID 3	1	127	60	4046	
CAN-open Node ID Adresse 4	Address setting CANOpen Node ID 4	1	127	61	4047	
CAN-open Node ID Adresse 5	Address setting CANOpen Node ID 5	1	127	62	4048	
CAN-open Node ID Adresse 6	Address setting CANOpen Node ID 6	1	127	63	4049	
CAN-open Node ID Adresse 7	Address setting CANOpen Node ID 7	1	127	64	4050	
CAN-open Node ID Adresse 8	Address setting CANOpen Node ID 8	1	127	73	4051	
CAN-open Node ID Adresse 9	Address setting CANOpen Node ID 9	1	127	74	4052	
CAN-open Node ID Adresse A	Address setting CANOpen Node ID 10	1	127	75	4053	
CAN-open Node ID Adresse B	Address setting CANOpen Node ID 11	1	127	76	4054	
CAN-open Node ID Adresse C	Address setting CANOpen Node ID 12	1	127	77	4055	
CAN-open Node ID Adresse D	Address setting CANOpen Node ID 13	1	127	78	4056	
CAN-open Node ID Adresse E	Address setting CANOpen Node ID 14	1	127	79	4057	
CAN-open Node ID Adresse F	Address setting CANOpen Node ID 15	1	127	80	4058	

8.4.3.5 Expert mode

Display	Description	min	max	Default	CAN param.	User adjustments
B.5 Expert parameter						
B.5.1 Brake parameter						
Threshold Motor Standst. mV	Limit value for detection of voltage standstill. A change affects the detection of motor standstill.	0	10000	4000	4069	
I-Amplification Brake	I-Amplification braking current control. Only with current regulation.	0	10	9	4008	
P-Amplification Brake	P-Amplification braking current control. Only with current regulation.	0	3)	3)	4009	
Current Low Lim. Brake %	In braking mode, a device malfunction is triggered after the measuring time has elapsed and the lower limit has been reached.	0	100	5	4516	
Monitor. Current Low Limit ms	Measurement time of the lower limit of the current in braking mode after which a device malfunction is triggered.	0	10000	500	4517	
Current HI Limit Brake A	In braking mode, after expiry of the measuring time and Electricity upper limit exceeded a device fault Triggered.	0	10000	10000	4518	
Monitor. Current HI Limit ms	Measurement time of upper limit of current in braking mode after which a device malfunction is triggered.	0	10000	300	4519	
Mode Delay Time Brake	With this parameter, the type of delay time (VZA) between motor release and activation of the braking current is selected. 1 = fixed delay time 2 = motor voltage dependent	1	2	2	4017	
Delay Time Brake ms	With the star-delta start option selected, a fixed delay time is always set. Delay between motor release and activation of the braking current at Mode Delay time 1 "fixed delay", see parameter 0x4017.	0	4000	300	4018	
Threshold Motor Voltage V	Limit value of the motor voltage at Mode Delay time 2 "motor voltage-dependent", see parameter 0x4017.	30	200	72A->300 132A->600 222A->900 360A->1200	4019	
Debounce Time Brake Relay ms	Duration of the bounce time of the brake relays. Close time between brake relay and control the braking current.	50	1000	50	4020	
Standstill Incr. Delta-t ms	Time range (dt) of the voltage increase for standstill detection due to the residual voltage.	4	200	40	4038	
Standstill Incr. Delta-U mV	Height (du) of the voltage rise at standstill detection due to remanence voltage.	200	20000	20000	4039	
Standstill OV Delta t ms	Time range (dt) of the 0-line undershoot during standstill detection due to remanent voltage.	4	1000	15	4040	
U-Remanence Cons Delta t ms	Time (dt) in which the remanence voltage must remain constant after motor standstill.	20	5000	1000	4041	
U-Remanence Cons Window mV	Limit value (u) minimum voltage at which the standstill detection works by means of the remanence voltage.	500	10000	10000	4042	
Toler. Remanence Voltage mV	Permissible voltage tolerance of standstill detection due to residual voltage.	0	500	100	4043	
U-Rem Values Out Of Tolerance	Number of values that do not have to be within the permissible tolerance of standstill detection due to residual voltage. *	0	1000	429	4075	
Sensitivity Curr Standstill	Sensitivity of current standstill detection * 0 = off 1 = medium 2 = high	0	2	1	4522	
Remanence Volt. Standst. OV	Standstill OV with standstill detection due to remanent voltage. * 0 = standstill detection due to remanent voltage Off 1 = standstill detection by remanence voltage on	0	1	1	4524	
Phase Angle Brake	solid phase angle. PE internally.	1600	9500	3000	4801	

* See warning note below.

3) depends on max. appliance braking current





Warning note *

The parameters identified with * may be changed only in discussion with PETER electronic. A change affects the identification of the motor standstill. A change can lead to a device failure in the worst case.

Display	Description	min	max	Default	CAN param.	User adjustments
B.5.2 System parameter						
Mains Switch-off Voltage V	Minimum mains voltage level in the 2 phases, which is identified as a switch-off threshold of the mains voltage. After the expiry of the Monitoring Time U-mains, Parameter 4501, a combined fault is triggered.	0	700	20	4507	
Monitoring Time U-mains ms	Measuring time of the mains disconnection up to the activation of a combined fault.	0	10000	250	4501	
Password 1	Access password to the Programming mode.	0	200	2	3008	
Password 2	Access password to the Expert mode	0	200	195	3009	
B.5.3 System reset						
System Reset Perform	All parameters are set according to the factory default setting. - Carry out reset to default No -> Leave reset menu. - Carry out reset to default Yes -> Device is set factory default setting. - Reset CAN communication - Reset fault storage - Reset max. values and operating data	0	4	0	3000	

8.4.4 Fault mode

If a fault occurs (see Chapter 12), the display changes into the Fault mode. According to the cause of malfunction, the display indicates the corresponding fault group, combined fault or device fault, output and the corresponding reason for malfunction.

By a short pressing of the button , a change is made into the status message mode. The groups combined fault, device fault or device status can be selected with the rotating encoder . Activate the selected group with the button . Now you can scroll between the corresponding messages of the selected group.

For leaving, press the button  shortly and a change is made back into the group menu. The status message mode is ended by long pressing and a return is made into the fault mode.

As a result of long pressing of the button  in Fault mode, a change is made into the main menu. Further operation is described under Chapter 8.4.1.2.

8.4.5 Operating sequence

8.4.5.1 Normal operation

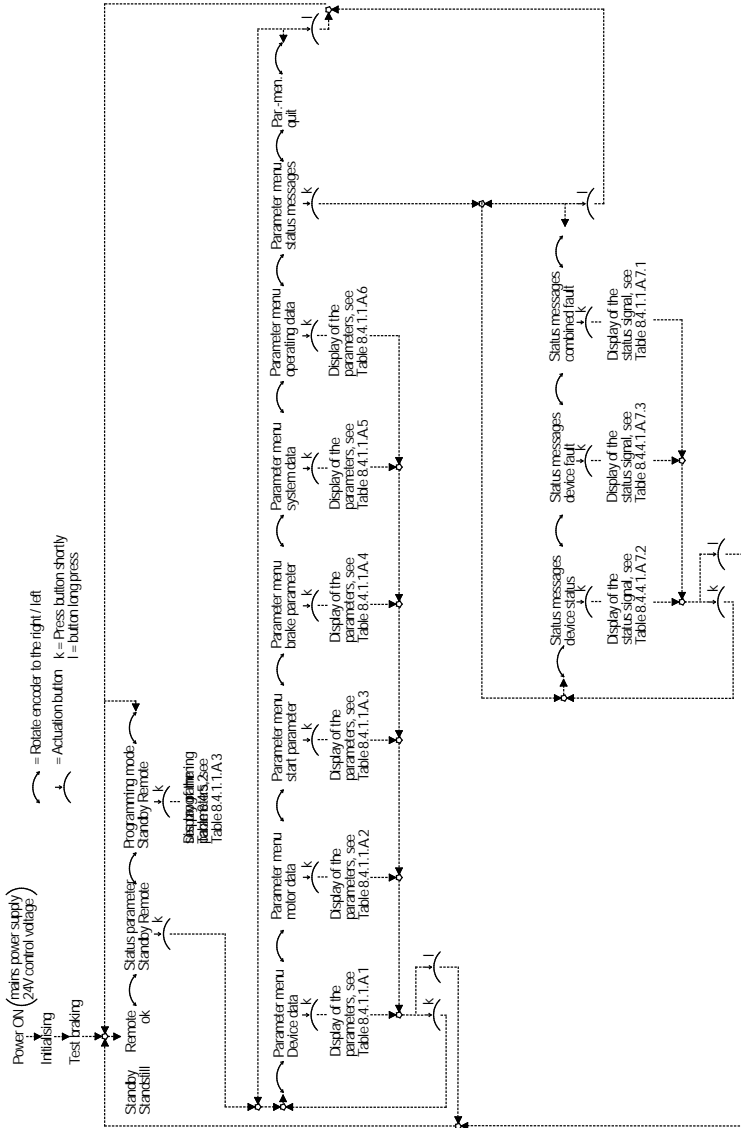

8.4.5.2 Programming

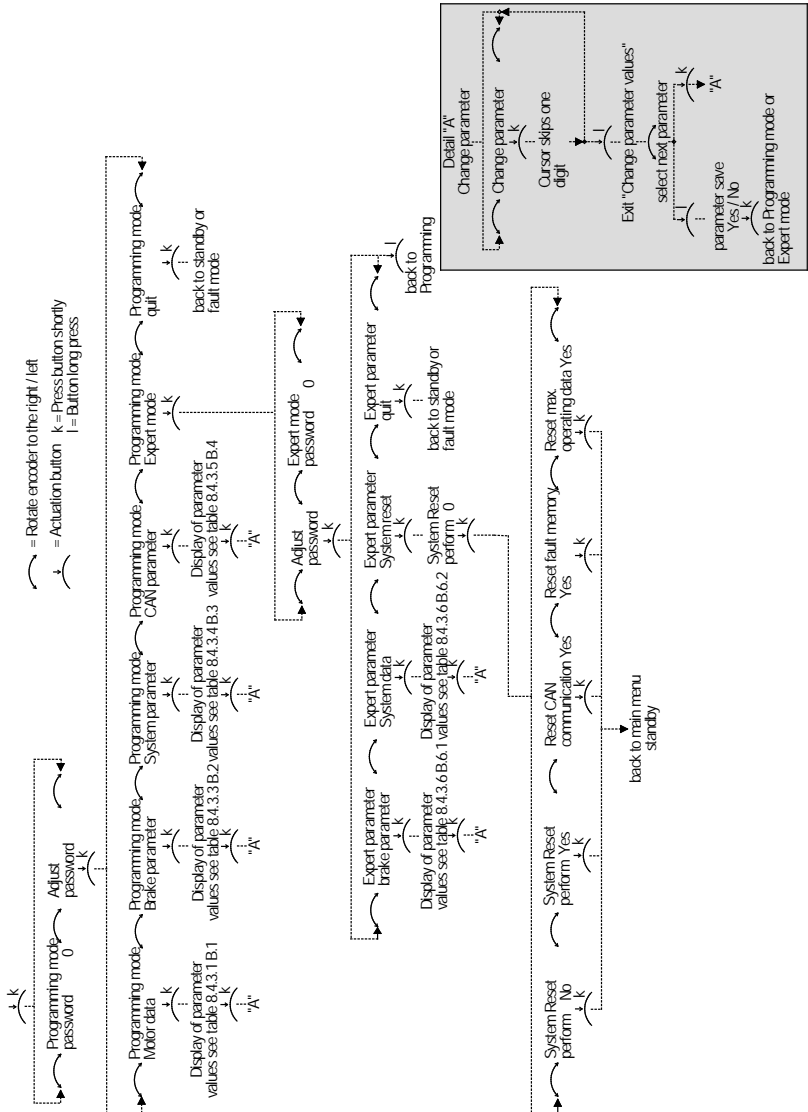

8.5 System reset

A reset to factory default setting, setting all parameters into the default status, can be implemented in three ways.

- The VB S ... can be set by simply wiring the reset input into the default status. Terminal 1 "L+" must be connected for 15s with terminal "FQ" for this purpose. If the device is reset to the default condition, then the yellow LED lights up briefly. All adjustments are now set to the default value.
- With the LC operator panel, the menu item system reset is selected in the Programming mode, in the Expert mode submenu and confirmed with "1". reset to factory default setting reset is implemented and the yellow LED lights up shortly. All adjustments are set to the default values.
- Over CAN bus, the CAN parameter 0x3000 is set to "1". All adjustments are then set to the default value.

9. Braking

9.1 Standstill-dependent braking with braking time optimisation

The motor is braked at the set current limit 15...100% of IBR_max. Initial braking is carried out with $2,5 \cdot I_{Mot}$ (CAN-Param. 0x4032), but always with a maximum of only IBR_max.

Depending on the inertia of the motor and the tool attached to the motor, the braking current regulates itself within three braking processes such that the drive comes to a standstill in the required time desired. In the factory, a required braking time of 8s is parameterised (CAN-Param. 0x3006). The regulation range within which the braking current can vary lies in the range 15...100% of IBR_max. the braking current is optimised after every braking procedure. The last braking parameters remain stored even if the mains voltage fails.

After a tool change or adjustment of the required braking time, a setting of the braking current is again reached after a maximum of 3 braking procedures with which the drive is stopped in the required braking time desired.

The braking time optimisation can only function correctly if the drive has reached its full revolution speed before braking. However, since the attainment of the nominal rotation speed of the drive cannot be monitored with the VersiBrake Safe, it is assumed that the start-up time of the drive corresponds approximately to the specified required braking time in (CAN-Param. 0x3006). That is, the braking time optimisation is not active until the set required braking time has elapsed after the motor is started, as it cannot be assumed that the drive has reached its full nominal revolution speed.

All parameters related to "Braking" can be adapted over the LCD operator panel or CAN bus.



Warning note:

Care must be taken that the specified switching frequency, see Technical Data in chapter 15, (test conditions according to DIN EN 12750) is not exceeded. In the operation modes "Standby" and "Motor running", the power semiconductors cool down.

9.2 Safety time

If no standstill is identified after a braking procedure, the safety time, or unbraked runout time elapses. The standstill notification output contact remains open until the end of the safety time (which prevents e. g. opening of a safety door). The unbraked runout time is the time until the free running drive safely reaches a standstill.



Attention: Electric shocks can be fatal!

Even if the motor stops, it is **not** isolated galvanically from the network.

10. Thermal overload protection

The device series VB S monitors the motor and device temperature.

10.1 Motor temperature monitoring

The type of the motor temperature probe is set via the system parameter "Motor temperature monitoring" (CAN-Parameter 0x4012).

A motor temperature switch, a motor PTC, a motor KTY84 or a PT1000 can be connected. Over CAN bus, a prior warning can be output as soon as the motor has reached the set-adjusted pre-warning temperature. The device enters the fault mode Collective fault if the motor exceeds the set shutdown temperature. This can be set with the system parameter "Switch off motor °C" (CAN-Param 0x4022).

If the motor temperature does not have to be monitored, a motor sensor can be dispensed with. TF- and TF+ must then be bridge-connected and a thermoswitch must be programmed over the parameterisation. Alternatively, a 1100 Ohm resistance can be connected between TF+ and TF-.

With the "Deactivation motor protection " function activated, (CAN-Param. 0x4033), no error message is issued if the set switch-off temperature is exceeded. However, the current motor temperature can be read via the LCD display or via CAN-Bus and a warning is given if the pre-warning temperature is exceeded.

10.2 Device temperature monitoring

10.2.1 thermal device image

A thermal overload protection for the appliance is integrated in the VB S. Operating currents are recorded with a current sensor and a thermal image of the appliance is calculated. The trigger value for the appliance has a fixed setting and corresponds to the heat capacity of the appliance. The thermal image can be considered simply as a buffer store which fills with appropriately high current flow and empties with appropriately low current flow. If the buffer store is full, it means that the appliance is thermally overloaded and the collective error "max. appliance temperature" (9 flashes) is issued. The braking current in the VB S is immediately switched off in this event in.

How long a certain braking current (factor current braking current/max. appliance braking current) may flow for can be seen in the diagram "trigger curve thermal appliance image VersiBrake Safe". 10.2.1 Thermal Appliance Image

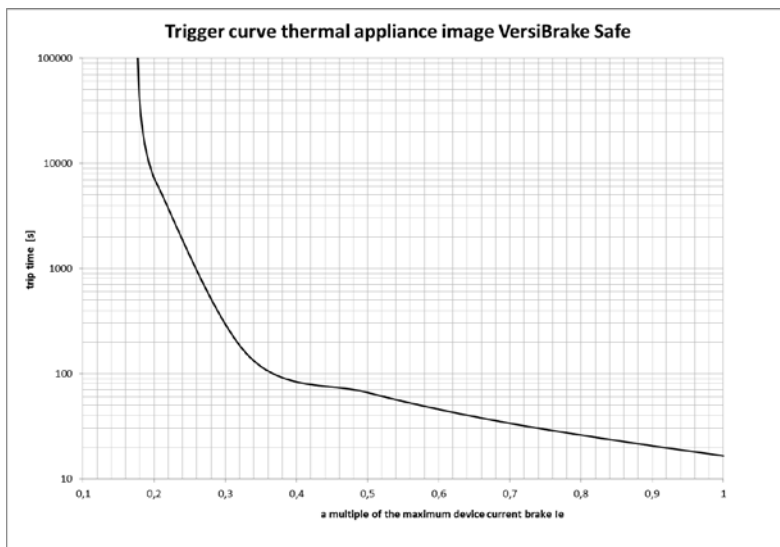

If the thermal capacity has been reached (the buffer store is filled) and the collective fault "max appliance temperature" has been triggered, the buffer store (thermal capacity) must be reduced to 80%, before this collective fault can be reset. It is however recommended that the appliance is allowed to cool for 5 minutes before re-starting the motor. The buffer store (thermal capacity) is then reduced to around 50%. If the motor is restarted and braked again before the expiry of this recommended cooling time, there is a danger that the buffer immediately fills again and the collective fault "max. appliance temperature" is triggered again.

The cooling curve can be seen from the diagram "Cooling curve thermal appliance image VersiBrake Safe".

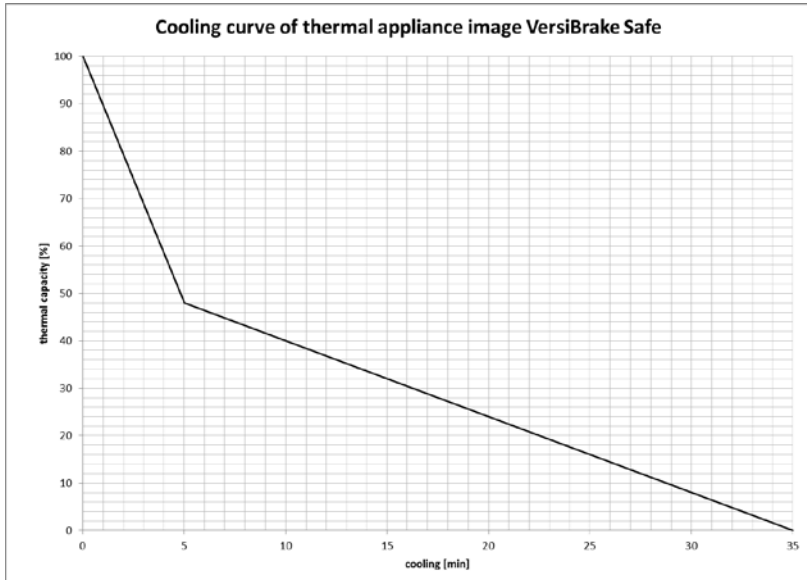

The VB S has a thermal memory. When the 24V control voltage is switched off the current value of the thermal capacity reached is saved. When the 24V control voltage is applied again, this value is reloaded. Resetting the thermal image by switching off the 24V control voltage is thus not possible.

The current value for the thermal appliance image can be posted in the status line of the display. On selection of "Thermal Appliance Image" the thermal capacity reached is showed in %. (see chapter 8.4.1.1)

10.2.2 Heatsink / device temperature

The heatsink temperature of the power module, as well as the device temperature, are monitored with temperature sensors. On reaching the adjusted device warning temperature, this can be adjusted with "Device Warning Temperature °C" (CAN-Param 0x4026), a warning issued over the CAN bus.

11. Extended, optional operation functions

11.1 External motor-standstill monitor

In operation on special or severely damaged mains supplies or in an area with high electromagnetic radiation there is a possibility that the device's internal motor-standstill recognition does not recognise a motor standstill. In this case, the motor standstill can be recorded by an external standstill monitor, e.g., VersiSafe. The safety functions and messages in the VB S relating to motor standstill are maintained. **Caution!** If the external standstill monitor has a safety level higher than SIL 1 or PL c the safety level reduces to the value of the VB S (SIL 1, PL c).

The standstill monitor is connected according to its commissioning instruction and a safety contact (open contact) of the external standstill monitor is switched between the terminals X3:1 (+24V) and X3:6 (ext. n0) of the VB S.

Involved parameters:

"external standstill monitor", CAN parameter 4004

Default value = 0

To activate the external standstill monitor, the value must be set to "1".

"Measurement period external braking time", CAN parameter 4015, unit ms (milliseconds).

Default value = 10 000 (ms)

This time must be selected 2 000 ms longer than the "brake time/time specification", CAN parameter 3006.

Example 1: If a time specification of 8,000 ms (CAN parameter 3006) is set in braking mode 0 (standstill dependent braking with braking time optimisation), the "Measurement period external braking time", CAN parameter 4015 must be set at 10, 000 (ms).

Example 2: If a time specification of 6,000 ms (CAN parameter 3006) is set in braking mode 2 (time-dependent braking), the "Measurement period external braking time", CAN parameter 4015 must be set at 8, 000 (ms).

NOTE! If too short a time is set, then after the third braking the collective error "3x k. standstill" will be triggered

"Meas. per. ext. standstill sig.", CAN parameter 4031, unit ms (milliseconds).

Default value = 6, 000 (ms)

During this time, the measured motor-terminal voltage (remanence voltage) must be 0. That means that the motor may not turn for at least the set time after the braking current is switched off. A standstill notification is only issued after this time has elapsed.

11.2 Recording tool speed

The rotational speed of the tool can be monitored by recording the tool rotational speed with the input "n Wz". The input can be used for identifying too large a deviation in the rotational speed and for identifying a belt tear. An inductive proximity switch 3-wire PNP, suitable for 24V DC, must be connected to the VC II S according to the recommended wiring. The sensor disc must be designed such that at maximum tool rotation speed the run time of a recording is 1.25ms.

Tool rotation speeds up to 12,000 rpm can be recorded with the following recommended sensor discs. All setting parameters for the tool rotation speed are coordinated to these sensor discs. If other sensor discs are used, it must be noted that the run time of the recording is not less than 1.25 ms and the actual minimum tool rotation speed set with ale CAN parameter 4078 must be divided by the factor in table 1.

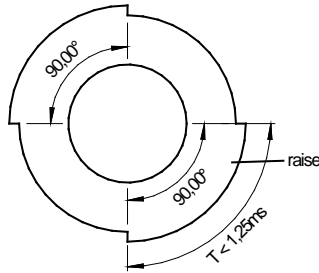

$$f = \text{Tool Speed} / 60 = 12000 \text{ min}^{-1} / 60 = 200 \text{ Hz}$$

$$T = \frac{1}{\text{Number of segments} * f} = \frac{1}{4 * 200 \text{ Hz}} = 0,00125 \text{ s} = 1,25 \text{ ms}$$

Table 1 – Various sensor discs

Number of segments	Max. tool speed (min ⁻¹)	Factor for actual min. Tool speed
4 *	12000	1
6	8000	1,5
8	6000	2
10	4800	2,5
12	4000	3
16	3000	4
20	2400	5
24	2000	6
32	1500	8

*recommended sensor discs

Parameters involved:

"extern. tool rotation speed sensor", CAN parameter 4035

Default value = 0 to activate external recording of the tool rotational speed, value must be set to "1".

"minim. tool rotation speed", CAN parameter 4078, unit min-1 (revolutions per minute).

Default value = 2,500

If the toll is below the set "minim. tool rotation speed" in Bypass operation, the collective error "tool rotation speed" is triggered.

The parameter value only corresponds to the actual tool rotation speed if the sensor disc with 4 segments is used. If other sensor discs are used, the actual tool rotation speed corresponds to the set "minim. tool rotation speed" divided by the "Factor" in Table 1

"tool rotation speed tolerance", CAN parameter 4076, unit %.

Default value = 80 (%)

If the tool reaches its nominal rotation speed, this rotation speed is assumed as the required value. If the rotation speed deviates by more than the permitted "tool rotation speed tolerance" in bypass operation, the collective fault "tool rotation speed" is triggered. The parameter value 80 (%) means that the tool rotation speed may not fall below 80% of the nominal rotation speed.

"Meas. per. tool-rot speed", CAN parameter 4016, unit ms.

Default value = 6,000 (ms)

If the motor changes to standby operation type after braking and identified motor standstill, the tool rotation speed continues to be recorded in this time. If a tool rotation speed is measured after this time has elapsed, the collective fault "tool rotation speed" is triggered.

11.3 Manual Brake cancellation

The function "manual brake cancellation" can be set using CAN parameter 0x4030 or the LCD operating panel. Manual brake cancellation enables non-activation or cancellation of a braking procedure. Restarting the motor after a braking cancellation is immediately possible. Manual braking is triggered by applying 24VDC to the input X3:3 "tool rotation speed".

If the option "Manual Braking cancellation" is selected, the input X3:3 "tool rotation speed" can no longer be used for recording a rotation speed.

11.4 Star delta start-up

The power contactors for desired star delta start-up can be driven with this function. The star-delta start-up can be parameterised with the CAN parameters 0x4200 to 0x4202 or via the LCD-operating panel. The collective fault relay is used to drive the star contactor and the operation status relay is used to drive the delta contactor.

If the delta start-up function is parameterised, the collective fault relay and the operation status relays can no longer be used as such.

The acceleration time of the star contactor can be parameterised with the CAN parameter 0x4201. An acceleration time of 4s is set by default. The factory-set switch time from start-contactor to delta contactor is 100ms. This switch time can be changed with the CAN parameter 0x4202. Both parameters, "acceleration time" and "switch time" can also be adjusted via the LCD operating panel Parameter.

The star contactor (collective fault relay X1:23-24) is already closed and the test braking carried out in the initialisation of the VersiBrake Safe. The star contactor (collective fault relay X1:23-24) is closed from the beginning. The adjustable acceleration time of the star contactor starts with the closure of the motor protection. After the acceleration time has elapsed, the star contactor opens (collective fault relay X1:23-24) and a parameterizable switch time is allowed to elapse until the delta contactor (operational status relay X1:13-14) closes.

If the motor protection is opened during the acceleration time for the star contactor or during the switching time, the braking procedure is carried out in star-contactor.

If, however, the motor protection is opened when the star-delta contactor acceleration has already completed, then the braking is in the delta circuit. After braking is complete, the delta contactor (operational status relay X1:13-14) is opened again, the switching time elapses and the star contactor (collective error relay X1:23-24) is closed again.

12. Operational signals

All information on the different operating states can be scanned over CAN bus. In addition, 3 light-emitting diodes are located on the device front side, which display the following operating states:

LED	Operating state
Green lights up	Device ready to operate
Red lights up	Device fault (safety-critical fault)
flashes red	Combined fault (not safety-critical fault)
yellow off	Operating state "Standby"
yellow flashes with changing frequency	Operating state "Start"
yellow lights up	Operating state "motor runs" (motor contactor is energized)
yellow flashes (double flashing)	Operating state "Brake"

Signal relays are available at the control terminal block X1. The following operating states are signalled:

13-14 Operating state

Closed during test braking and from the beginning of "Motor Start" until the end of braking. The function of the operating state contact can be adjusted over the system parameter "Opts Operating State Relay" (CAN Parameter 0x4077).

If the "Star-Delta acceleration" is parameterised (CAN param. 0x4200), the operational status relay is used as delta relay. It is not then possible to use it as operational status contact.

23-24 Combined fault

The signal contact is closed in normal operation and opens only if a combined fault has occurred.

If the "Star-Delta acceleration" is parameterised (CAN param. 0x4200), the collective fault relay is used as star relay. It is not then possible to use it as collective fault contact.

33-34 Device fault - positively-driven safety relay

The signal contact is closed in normal operation and opens only if a safety-critical device fault has occurred.

43-44 Motor standstill - positively-driven safety relay

The signalling contact is open in case of rotating motor and closes only if a motor standstill has been securely identified.

53-54 locking – driven safety relay

The locking contact is closed during operation modes "Standby" and „Motor running“. In the operation modes "Test braking", "Braking" and "Fault", the locking contact is open. This contact is also wired in the control circuit of the motor protection and locks the motor switch-on.

13. Faults

In the device two fault groups are differentiated.

13.1 Combined fault

Combined under "Combined fault" are the following faults that do not affect the safety functions, however, in spite of that influence the function of the VB S:

Combined faults			
LED red	LED flashes yellow	LC display	Reason for malfunction
flashes	1x	Failure L2 L3	Failure of mains power supply L2, L3
flashes	2x	Tool speed	Error is only active if the "Tool rotation speed monitoring" (CAN param. 0x4035) is switched on. In the "Motor running" operation mode, the error message is triggered if the tool rotation speed measured via the control input X3:3 is below the minimum set tool rotation speed (CAN param. 0x4078), or the measured tool rotation speed is outside the specified tolerance (CAN param. 0x4076). In the "Standby" operation mode, the error is issued if a tool rotation speed is measured.
flashes	3x	Max Heatsink Tmp	maximum permissible motor over-temperature exceeded see point 10.2.1
flashes	4x	max. braking time	maximum permissible heatsink temperature exceeded see point 10.2.2
flashes	6x	3x no standstill	Error is only active if the "Collective fault 3x no standstill" (CAN param. 0x4021) is parameterised. By default, this error is switched on. If the motor standstill is not identified three times in succession in the monitoring time, the collective error "3x no standstill" is issued. The monitoring time is factory-set at 10 seconds and can be adjusted via the CAN parameter 0x4005. In the parameterisation of an external standstill monitor (CAN param. 0x4004) it behaves identically to the error notification, except that the monitoring time for the external standstill signal must be adjusted via a separate parameter (CAN param. 0x4015).
flashes	7x	Motor size	During test braking, the braking current exceeds the max. appliance braking current Ie. Connected motor too big.
flashes	8x	max. braking time	If maximum monitoring time of 25 sec. has expired and no motor standstill has been identified.
flashes	9x	max. device temp	The thermal appliance image has identified an overload of the appliance.
flashes	10x	Start input	No break contact attached to the motor protection at the start input. Start input is opened at initialisation.

With the occurrence of one or more of these faults, the drive is switched off, the device goes into the operating mode "Combined fault" and the contact of the signal relay "Combined fault" is opened. The locking contact is open and locks the motor's switch-on. The operating mode "Combined fault" is displayed by the flashing of the red LED.

The fault source can be scanned over the CAN bus or the LCD operator panel.

For the resetting of this fault, the interference source must be removed and 24 V applied for a short time on the input, Terminal 5 (FQ) (<15 sec).

If a collective fault arises with a parameterised "start-delta start-up" function (CAN-Param. 0x4200), the appliance moves into the operation type "Collective fault" and the drive is switched off as described above. The notification relay "collective fault" is used at star-relay in the parameterised "star-delta-start-up" (CAN param. 0x4200). Signalisation of a collective fault is no longer possible with "star-delta-start-up" (CAN param. 0x4200) selected.

13.2 Device fault

Combined under "Device fault" are the following faults which could affect the safety functions and bring the device into a safety-critical operating state:

Device faults			
LED red	LED flashes yellow	LC display	Reason for malfunction
lights up 1x		Missing Zero-Crossing L2 – T2 / L3 – T3	synchronisation impulse for ignition of the brake thyristors are no longer recognised. Causes: - Short-circuit between mains and motor side of the VersiBrake Safe - Motor circuit open - Mains voltage failure - Circuit internally defective
lights up 4x		Zero-Crossing L2-L3	Zero transitions of the mains voltage L2 – L3 are no longer recognised. Causes: - Failure of the mains voltage L2 or L3 - Short circuit freewheel arm - Circuit internally defective in zero transition identification
lights up 7x		Pol. Braking current	Polarity (current direction) of the braking current is wrong at the start of braking. Causes: - voltage and frequency instabilities in the mains voltage
lights up 8x		Freewheel. Fault	No freewheel current flows during the braking procedure. Causes - Circuit internally defective
lights up 9x		Over Current	Braking current greater than the value set in CAN param. 0x4518, over the duration of the set measurement period (CAN param. 0x4519). Causes: - Short-circuit motor circuit - Circuit internally defective
lights up 10x		Under Current	Braking current lower than the percentage value of set motor nominal current set in CAN param. 0x4516 (CAN param. 0x4032), over the duration of the set measurement period (CAN param. 0x4517). Causes: - Motor circuit open - Mains voltage failure - Circuit internally defective

Device faults			
lights up	11x	Motor voltage detection	Defect of the motor voltage recording during operation Causes: - Motor wiring T1 not connected - Circuit internally defective
lights up	13x	Braking current	Test braking failed, braking current smaller than 2A. Causes: - Interruption in motor circuit - Circuit internally defective
lights up	14x	Motor voltage	Test braking failed, motor voltage recording defective. Causes: - Interruption in motor circuit - Circuit internally defective in the motor voltage measurement circuit
lights up	15x	Diagnosis Output	Monitoring of the safety- orientated outputs "Standstill notification relay", "locking relay" and "device fault error". Causes: - Relay contact welded / stuck - Circuit internally defective
lights up	16x	Diagnosis Input	Monitoring of the safety- orientated inputs "Brake signal", "External rotary encoder", "External standstill monitoring" and of the internal control voltages 24V and 3.3V Causes: - short circuit between the input signals - Circuit internally defective
lights up	19x	EEPROM	Error in the data stored in the EEPROM blocks. Cause: - Bit error
lights up	20x	Device data	Initialisation error, not possible to determine appliance nominal appliance voltage and nominal appliance current. Cause: - Circuit internally defective
lights up	21x	undef. Status	Program crash of the μ -controller
lights up	22x	RAMTEST	Internal storage error of the μ -controller Causes: - Bit error of an internal variable

With the occurrence of one or more of these faults, the drive is switched off, the device goes into the operating mode "Device fault" and the secure contact of the signal relay "Device fault" is opened. The locking contact is open and locks the motor's switch-on. The operating mode "Device fault" is displayed with a permanent lighting up of the red LED.

The fault source can be scanned over the CAN bus or the LCD operator panel.

13.3 Reset fault

In the case of an error, proceed as follows:

Combined fault	After the elimination of the fault, the error message can be reset over the input "Fault reset".
Device fault	After elimination of the safety critical fault, the error message can be reset with a short switch-off (5sec) of the 24V control voltage. If the error cause cannot be eliminated, the error message remains present in spite of a reset attempt.



Warning note:

In every case the fault cause must be determined and remedied by instructed personnel. Only after that may the device be put into operation again.

14. CAN-BUS

All CAN signals are isolated galvanically from device-internal voltages. The connection is implemented over RJ45 plug (X10 and X11, see point 8.2 Connection). As delivered, a baud rate of 125 kBaud is adjusted.

On the front of the appliance is an address selector switch (see 8.4). A unique Node ID (address) is assigned to the VersiBrake Safe in an CANOpen-Network with this address selector switch. This is set to 0 in delivery condition. This corresponds to a Node-ID of 57. Using CAN parameters or the LCD operation panel, an individual Node-ID (address) can be assigned to every address selector switch position, see 8.4.3.4 CAN parameter.

For a trouble-free transfer of the CAN data, it is absolutely necessary that the following be considered:

- After every switchover of the address switch, a short switch-off of the 24 V control voltage is necessary (reset).
- If only one CAN subscriber is plugged on a device, and the CAN plug for this subscriber is removed and plugged in again, a short switch-off of the 24 V control voltage is required (reset).
- If only one CAN subscriber is plugged on a device, a plug with terminating resistor is to be inserted into the second CAN socket.

If the appliance description file (EDS file) and comprehensive documentation of the available CAN parameters of the VersiBrake Safe appliances, please contact us.

15. Technical data

15.1 General specifications

Type designation	VersiBrake S 480/600/690-...			
	72	132	222	360
Device rated current I_b	72A	132A	222A	360A
Rated operating voltage U_b	200...480VAC / 400...600VAC / 480...690VAC $\pm 10\%$ 50/60Hz			
Control voltage U_c	24VDC $\pm 10\%$ / 0,5A			
Motor rated power at U_b 400V - IE3 Motors	7,5 kW	15kW	25kW	45kW
Motor rated power at U_b 400V - IE2 Motors	15kW	30kW	55kW	90kW
Recommended rated motor currents at	13...30A	32...55A	65...100A	128...160A
Switching cycle per hour at $t_{br}=10s$ with I_e	50	30	17	18
Utilisation category ...AC-53b:6-6:114	72A; AC-53b; 1-10; 62	132A; AC- 53b; 1-10; 110	222A; AC- 53b; 1-10; 202	360A; AC-53b; 1-10; 190
max. power dissipation - in operation with max. start frequency with $t_{br}/t_{br}=10s$ with resp. $3 \times I_{rated}$ (device) - control voltage only	22W 6W	22W 6W	22W 6W	36W 6W
$I^2t(125^\circ)$ (A ² s) - Thyristors in L1, L3	720	16200	16200	125000
$I^2t(125^\circ)$ (A ² s) - Freewheeling Thyristors	720	4000	4000	51200
Minimum motor load	40% of the device rated current			
Braking time	fixed braking time 0.25 ... 25s or Self-optimising (default)			
Restart time	200ms			
Control voltage U_c	24VDC $\pm 10\%$			
Input impedance control inputs	5kOhm			
Switching capacity relay outputs	4A / 250VAC / 30VDC			
Installation class	3			
Overvoltage category / Pollution degree: Control and auxiliary circuit Main circuit	III / 2 III (TT / TN / IT - Network) / 2			
Rated impuls strength U_{imp} ; Control and auxiliary circuit Main circuit	4kV 6kV			
Rated insulation voltage U_i ; Control and auxiliary circuit Main circuit	250V 600V			
max. Cross-sectional area for connection solid/stranded: Control terminals Power terminals Length of the insulation stripping or wire end sleeve	1.5 mm ² 1.5 ...16 mm ² 18mm		1.5 mm ² 6 ... 35mm ² 15mm	
max. tightening torque: Control terminals Main circuit	Push-in terminal Push-in terminal		Push-in terminal 3 ... 3.5Nm 26.6 ... 31lbs-in	
Drive connecting screws	-		hexagon socket 5mm	
Weight	1.35kg	1.45kg	1.45kg	3.6kg

15.2 EMC Information

Radiated interference	Standby/Bypass operation: DIN EN 61000-6-3:2011-09 Start/Braking operation: DIN EN 60947-4-2:2018-12
Installation class (according to EN 61000-4-5)	3
Characteristic criteria according to DIN EN 60947-4-2 in case of test level for CE Test.	1 or 2 (if failure, then only in secure direction)
According to characteristic criteria DIN EN 60947-4-2 in case of increased test level for "Functional safety" (SIL1) according to DIN EN 61326-3-1.	3 (if failure, then only in secure direction)
DIN EN 61000-4-2; ESD CE Test: SIL1-test:	4 kV contact / 8 kV air 6 kV contact / 8 kV air
DIN EN 61000-4-3; EMF CE Test: SIL1-test:	0.08-1GHz 10/m, 1.4-2.7GHz 3V/m 0.08-1GHz 20/m, 1.4-2GHz 10V/m, 2-2.7GHz 3V/m
DIN EN 61000-4-4; BURST CE Test: SIL1-test:	Network/Motor 2 kV, I/O signal 1kV Network/Motor 3kV, 2 kV I/O signal, CAN bus 2 kV
DIN EN 61000-4-5; SURGE CE Test: SIL1-test:	Network/Motor connections 1 kV conductor-conductor, 2 kV ground conductor 2kV conductor-conductor, 4kV ground conductor
DIN EN 61000-4-5; SURGE CE Test: SIL1-test:	I/O signal asymmetric 1kV conductor-conductor, 2kV ground conductor 2kV conductor-conductor, 4kV ground conductor
DIN EN 61000-4-5; SURGE CE Test: SIL1-test:	Screened CAN-Line 1kV ground conductor 2 kV ground conductor
DIN EN 61000-4-6; HF Field CE Test: SIL1-test:	0.15-80MHz 10V 0.15-80MHz 10V
DIN EN 61000-4-8; magnetic fields CE and SIL1-test:	30 A/m
DIN EN 61000-4-11; short interruption CE and SIL test	0% 250/300 network periods (5000 ms)
DIN EN 61000-4-11 voltage dips CE and SIL test	{ 0% 1 network period (20 ms/16.67 ms) 40% 10/12 network periods (200 ms) 70% 25/30 network periods (500 ms)
DIN EN 61000-4-13 harmonic component CE and SIL test	Class 3

15.3 Environmental conditions

Ambient temperature	-15°C ... 45°C to 1000 m height
Storage temperature	-25°C ... 75°C
Power reduction	Greater than 45°C -2% per 1°C to max. 50°C and installation levels above 1000 m -1% per 100 m
Protection type	IP 20

15.4 Safety specifications

Functional safety according to DIN EN 61508	SIL 1
Safety of machines according to DIN EN 13849	PL c
Safety functions:	<ul style="list-style-type: none"> • Prevention of an unexpected, fault-dependent starting • Monitored, controlled braking down - Secure control activation of the protection door interlocking - Motor standstill monitoring
MTTFd	
PFH	
B10d	

15.5 Dimensions

	A	B	C	D	E*
VB S, 72 – 222A (size 1)	103mm	230mm	138mm	86mm	220mm
VB S, 360A (size 2)	205mm	230mm	160mm	183mm	220mm

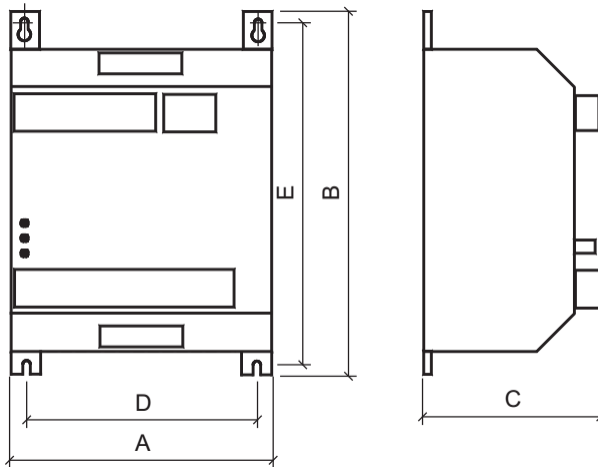

16. Dimensioning rules

16.1 Dimensioning of fuses for device protection

The pre-fuses can be dimensioned based on the following instruction:

With a fusing according to allocation type "1" to DIN EN 60947-4-2, the VB S may be inoperative after a short-circuit. After an overload or after an output-sided short-circuit, maintenance work is possible.

The following dimensioning rules refer to the following operating conditions:

- Utilisation of asynchronous motors IE1, IE2 and IE3 (IE4 in preparation)
- Braking times according to datasheet
- Switching frequency not higher than as indicated in the datasheet

Fusing according to allocation type "1"

Fuses of the operating class gG are recommended as pre-fuses.

If these fuses are also used as line protection, the line cross-section is to be correspondingly coordinated!

Short-circuit protection according to EN 60947-4-2

Device rated current (Technical data)	Device type	Fuse rating with allocation type 1	Fuse type (recommendation)
72A	VB S ...-72	25A	gG
132A	VB S ...-132	40A	gG
222A	VB S ...-222	63A	gG
360A	VB S ...-360	100A	gG

Fusing according to coordination type "2"

The power semiconductors are to be protected by semiconductor protection fuses of the utilization category aR or gR. However, since these fuses do not ensure line protection, it is necessary to use additionally line protection fuses (utilization category gG).

To protect the semiconductors it is necessary to select fuses having cut-off- I_{2t} -values which are approx. 10-15% below the threshold- I_{2t} -value of the power semiconductor (see technical data). In this connection, the fuse rating of the selected fuse should not be smaller than the starting current to be expected.

Notes:

1. PETER electronic does not prescribe the use of semiconductor protection fuses. However, for some UL- or CSA-listed devices there are exceptions which are indicated in the relevant commissioning instructions.
2. On the basis of the I_{2t} -value of the power semiconductors, the braking time and possibly the max. braking current, the fuse supplier is able to select a suitable type. Due to the great variety of producers, sizes and types, PETER electronic does not recommend any particular fuses.
3. If the value of the fuse or the cutoff- I_{2t} -value is selected too small, it may happen that the semiconductor fuse reacts during the soft stop.

16.2 Motor protection switch

16.2.1 IEC / Europe 400 V

Device rated current (Technical data)	Device type	Siemens	EATON
72A	VB S ...-72	3RV2031-4CA.. (IN=22A, Ir=16A)	PKE65-XTU-65 (IN=65A, Ir=16A)
132A	VB S ...-132	3RV2031-4PA.. (IN=35A, Ir=30A)	PKE65-XTU-65 (IN=65A, Ir=30A)
222A	VB S ...-222	3RV2031-4KA.. (IN=66A, Ir=62A)	PKE65-XTU-65 (IN=65A, Ir=53A)
360A	VB S ...-360	3RV2031-4KA.. (IN=66A, Ir=65A)	PKE65-XTU-65 (IN=65A, Ir=65A)

17. Installation guideline

The devices are to be installed into a switchbox or switchgear cabinet according to point 7. It must be ensured that the switchbox/switchgear cabinet is capable of dissipating the occurring power loss (see techn. data).

17.1 Connection

The device is to be installed according to the attached connection diagram. For other connections please consult PETER electronic GmbH & Co. KG..

17.2 Earthing

The electrical earthing provided ensures a low impedance connection between all metallic surfaces. Apart from providing a degree of electrical safety and isolation, the earthing also has the beneficial effect that the flow of RF currents can be directed through the structure of the equipment rather than through sensitive circuits, where it could be disruptive. It is for this reason that it is vitally important to provide separate earth conductors for each part of the installation which are all connected to a common star point.

17.3 Cabling

To avoid EMI couplings into the electronics and the disturbances they involve, it must be ensured that the control cables are laid separately in separate cable ducts and as far as possible away from the power cables. If control cables need to cross power cables, they have to be laid at an angle of 90° (Figure 1).

When connecting shielded cables, make sure that the unshielded cable ends are as short as possible. The large-surface shield bonding must necessarily be located at the end of the shielding but may also be established in a suitable place - at a distance of some centimeters (Figure 2).

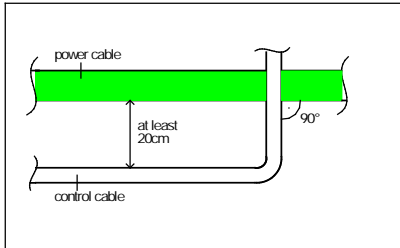

Figure 1

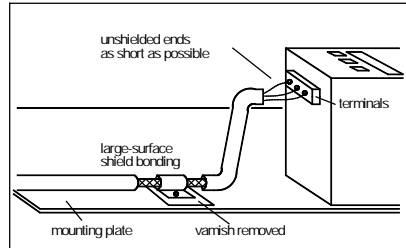

Figure 2



Caution!

The protective conductor connection to the motor must not be laid in shielded motor cables, but is to be separately laid with an appropriate cross-sectional area. The individual earthing systems, power earth, protective earth, digital earth, and analog earth conductors should be laid separately by using a suitable star-point wiring.

Note: Further connection diagrams for special circuit arrangements are available on our homepage at www.peter-electronic.com.

Note: Prior to putting the VersiBrake S into operation, the wiring is to be checked.

18. General connection diagram

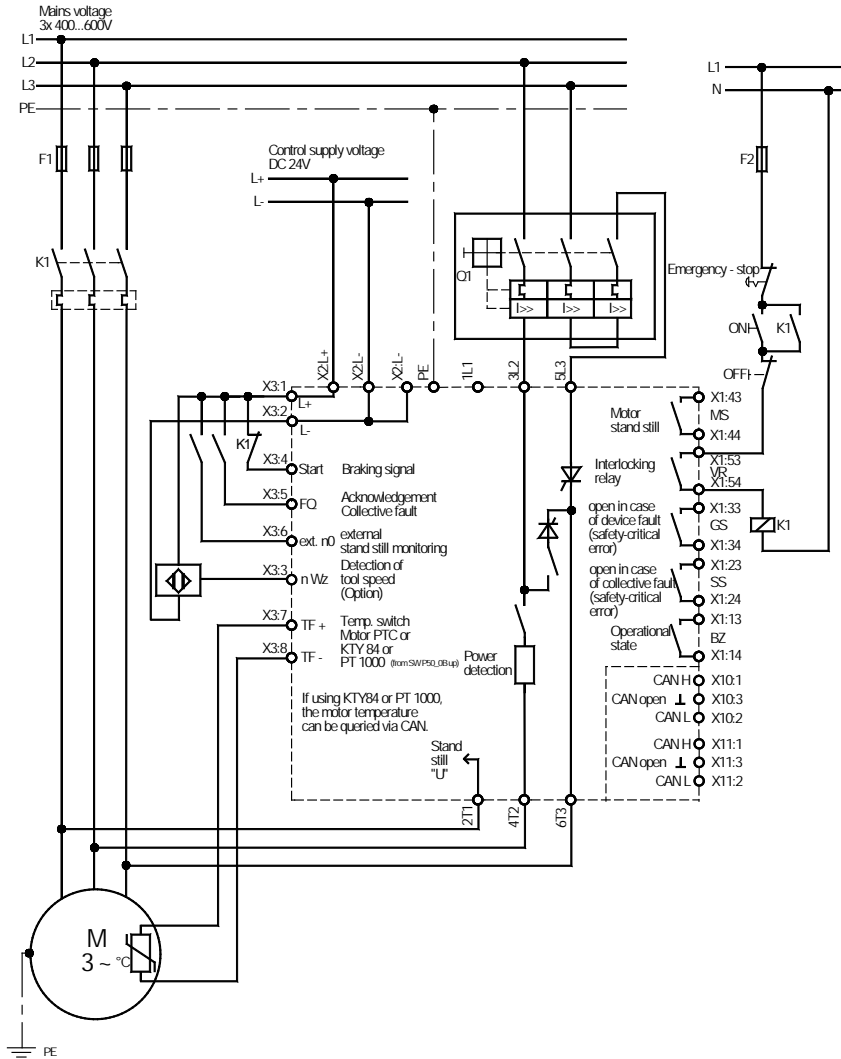

Note: Further connection suggestions on our homepage at www.peter-electronic.com.

19. Timing diagram

19.1 Switch-on of the control voltage 24 V DC

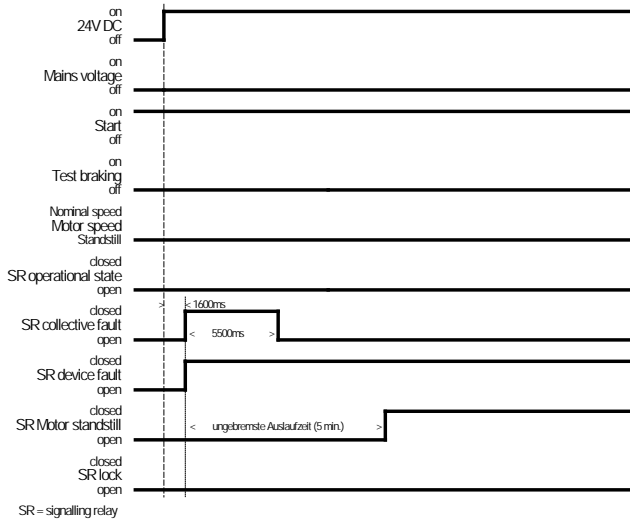

19.2 Switch-on of the 24 V DC control voltage and the mains voltage

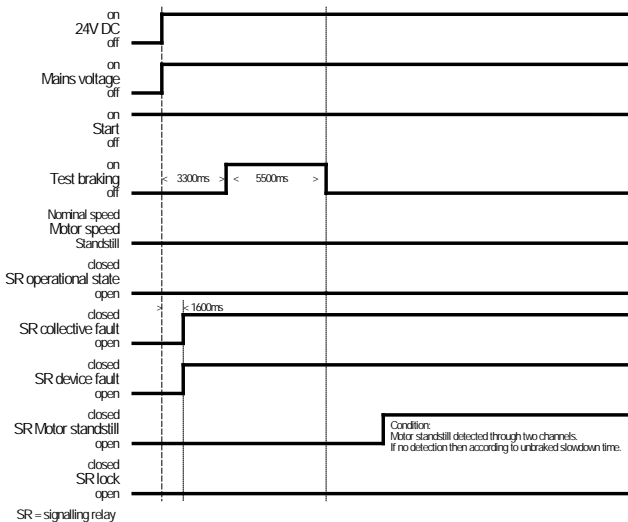

19.3 Start/Stop procedure

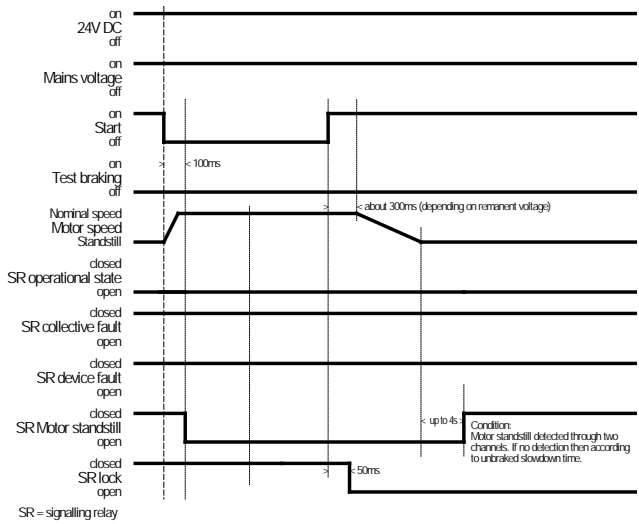

19.4 Switch-on of the voltages if motor rotates

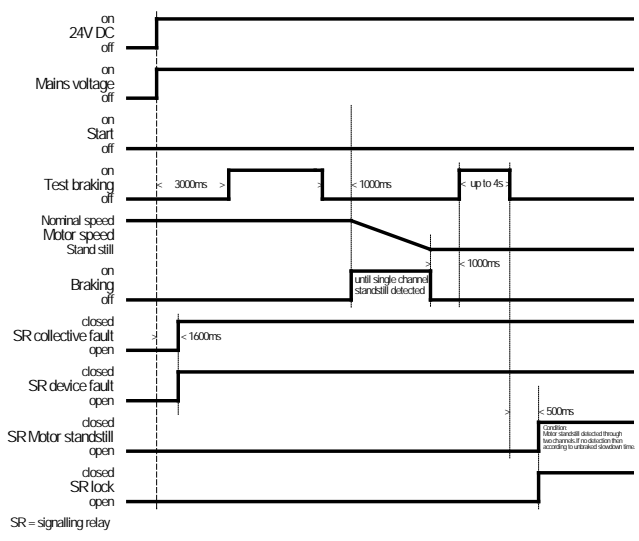

19.5 Occurrence of an device fault

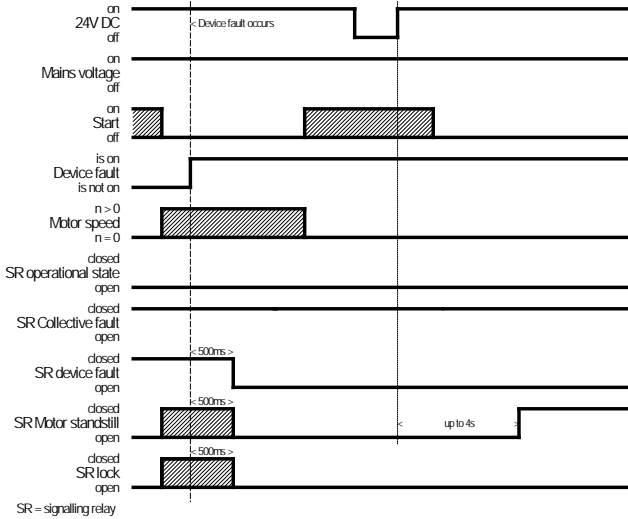

19.6 Occurrence of a Combined fault

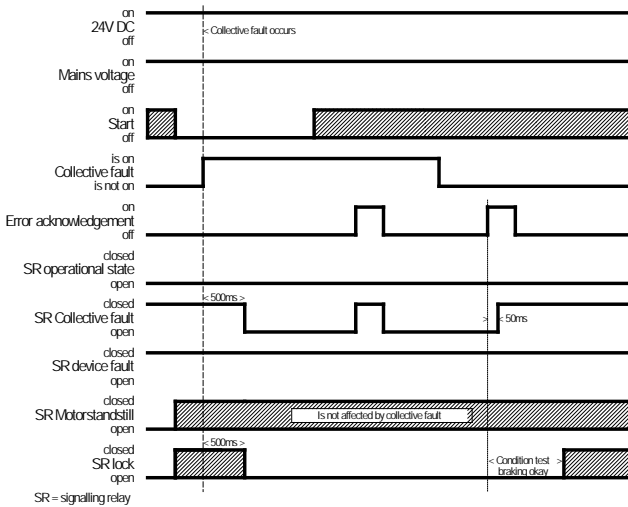



www.peter-electronic.com

