

Ezi-SERVO[®]

Closed Loop Stepping System

- Intergrated Controller
- Position Table
- Closed Loop System
- No Gain Tuning / No Hunting
- High Resolution / Fast Response

Plus-R



UL[®] US CE

FASTTECH



Ezi-SERVO® **Plus-R**

Closed Loop Stepping System
with Network Based Motion Controller



1 Network Based Motion Control

A maximum of 16 axis can be operated from a PC through RS-485 communications. All of the Motion conditions are set through the network and saved in Flash ROM as a parameter. Motion Library(DLL) is provided for programming under Windows 2000/XP.

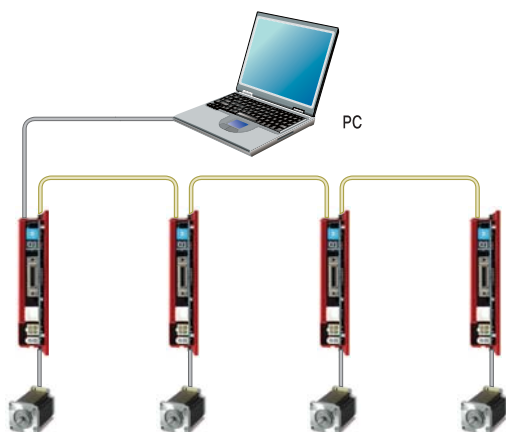

2 Position Table Function

Position Table can be used for motion control by digital input and output signals of host controller.

You can operate the motor directly by sending the position table number, start/stop, origin search and other digital input values from a PLC.

The PLC can monitor the In-Position, origin search, moving/stop, servo ready and other digital output signals from a drive.

A maximum of 256 positioning points can be set from PLC.

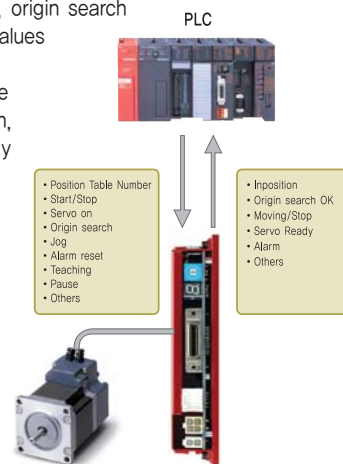

3 Closed Loop System

Ezi-SERVO[®] is an innovative closed loop stepping motor and controller that utilizes a high-resolution motor mounted encoder to constantly monitor the motor shaft position. The encoder feedback feature allows the Ezi-SERVO[®] to update the current motor shaft position information every 25 micro seconds. This allows the Ezi-SERVO[®] drive to compensate for the loss of position, ensuring accurate positioning. For example, due to a sudden load change, a conventional stepper motor and drive could lose a step creating a positioning error and a great deal of cost to the end user!

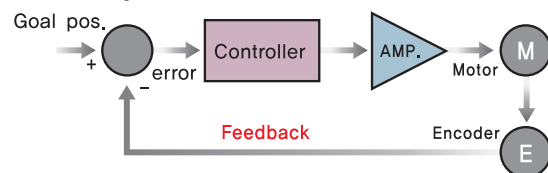

4 No Gain Tuning

Conventional servo systems, to ensure machine performance, smoothness, positional error and low servo noise, require the adjustment of its servo's gains as an initial crucial step. Even systems that employ auto-tuning require manual tweaking after the system is installed, especially if more than one axis are interdependent, Ezi-SERVO[®] employs the best characteristics of stepper and closed loop motion controls and algorithms to eliminate the need of tedious gain tuning required for conventional closed loop servo systems. This means that Ezi-SERVO[®] is optimized for the application and ready to work right out of the box! The Ezi-SERVO[®] system employs the unique characteristics of the closed loop stepping motor control, eliminating these cumbersome steps and giving the engineer a high performance servo system without wasting setup time. Ezi-SERVO[®] is especially well suited for low stiffness loads (for example, a belt and pulley system) that some-time require conventional servo systems to inertia match with the added expense and bulk of a gearbox. Ezi-SERVO[®] also performs exceptionally, even under heavy loads and high speeds!

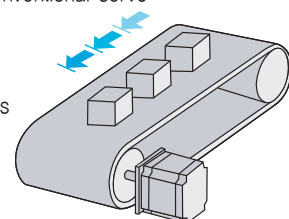

5 No Hunting

Traditional servo motor drives overshoot their position and try to correct by overshooting the opposite direction, especially in high gain applications. This is called null hunt and is especially prevalent in systems that the break away or static friction is significantly higher than the running friction. The cure is lowering the gain, which affects accuracy or using Ezi-SERVO[®] Motion Control System! Ezi-SERVO[®] utilizes the unique characteristics of stepping motors and locks itself into the desired target position, eliminating Null Hunt. This feature is especially useful in applications such as nanotech manufacturing, semiconductor fabrication, vision systems and ink jet printing in which system oscillation and vibration could be a problem.

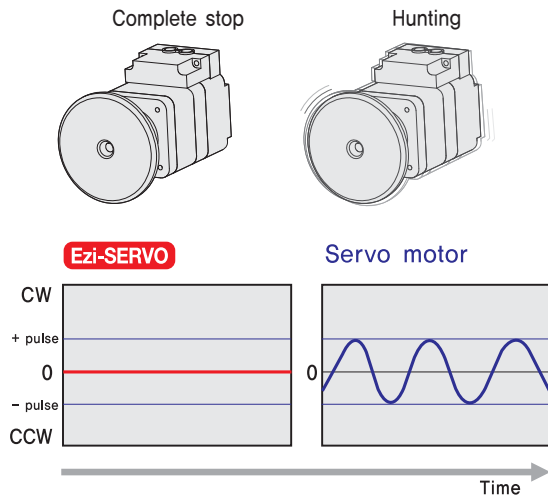

8 High Resolution

The unit of the position command can be divided precisely. (Max. 32,000 pulses/revolution)

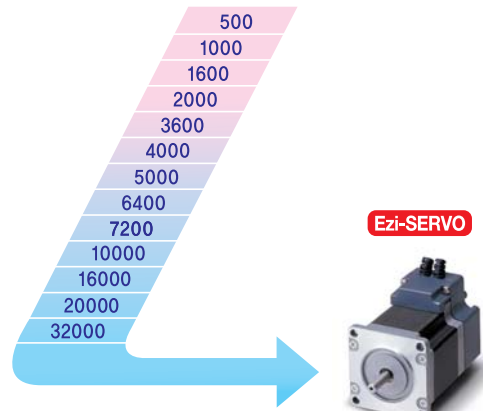

9 High Torque

Compared with common step motors and drives, Ezi-SERVO[®] motion control systems can maintain a high torque state over relatively long period of time. This means that Ezi-SERVO continuously operates without loss of position under 100% of the load. Unlike conventional Microstep drives, Ezi-SERVO[®] exploits continuous high-torque operation during high-speed motion due to its innovative optimum current phase control.

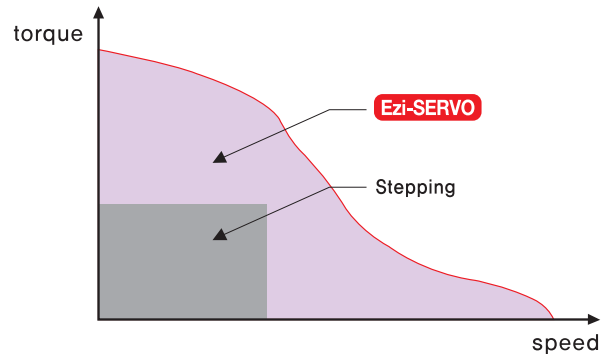

6 Smooth and Accurate

Ezi-SERVO[®] is a high-precision servo drive, using a high-resolution encoder with 32,000 pulses/revolution. Unlike a conventional Microstep drive, the on-board high performance DSP (Digital Signal Processor) performs vector control and filtering, producing a smooth rotational control with minimum ripples.

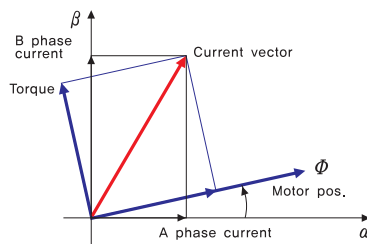

7 Fast Response

Similar to conventional stepping motors, Ezi-SERVO[®] instantly synchronizes with command pulses providing fast positional response. Ezi-SERVO[®] is the optimum choice when zero-speed stability and rapid motions within a short distance are required. Traditional servo motor systems have a natural delay between the commanding input signals and the resultant motion because of the constant monitoring of the current position, necessitating a waiting time until it settles, called settling time.

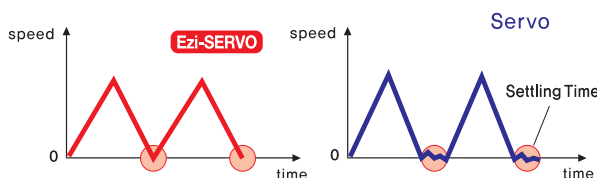

10 High Speed

The Ezi-SERVO[®] functions well at high speed without the loss of Synchronism or positioning error. Ezi-SERVO[®]'s ability of continuous monitoring of current position enables the stepping motor to generate high-torque, even under a 100% load condition.

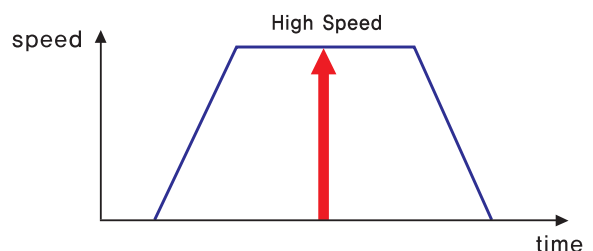

● Features of Motion Controller

1. Loop Count

This function allows positioning repeatedly according to the Loop Count Number.

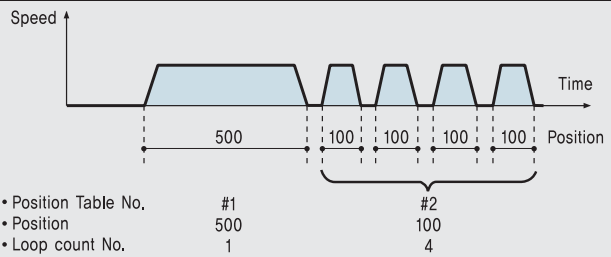

2. Acceleration/Deceleration

For quick acceleration and gradual deceleration, you can set each acceleration and deceleration time separately.

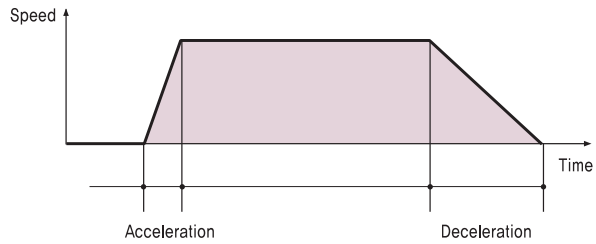

3. Pause

You can pause the motion upon the input of an external signal. When Pause signal change to OFF, the motor will restart to original target position.

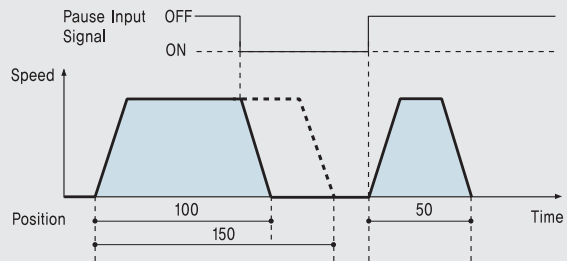

4. Alarm

The number of LED flashing time indicates which Alarm has occurred.

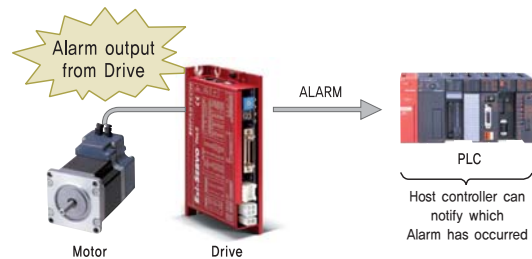

5. Teaching

Teaching signal is used to memorize current Position data into the selected Position Table item.

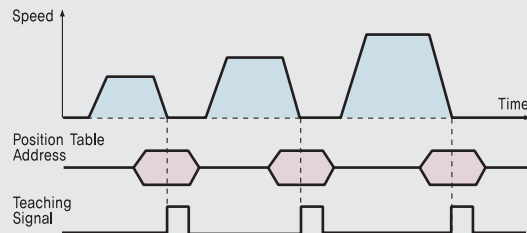

6. Jump

Within one Position Table, you can select various Position Table numbers that you want to jump. With three external input signal during movement, the next jump Position Table number can be select.

◆ Position Table #14

Position	---	Next	---	Input 1	Input 2	Input 3	---
10000		100		115	116	117	

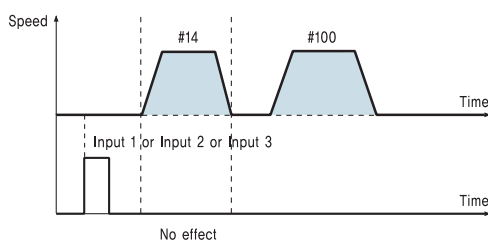

No effect

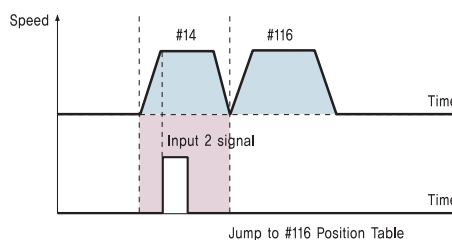

Jump to #116 Position Table

● Part Numbering

Ezi-SERVO-PR-42S-A-□

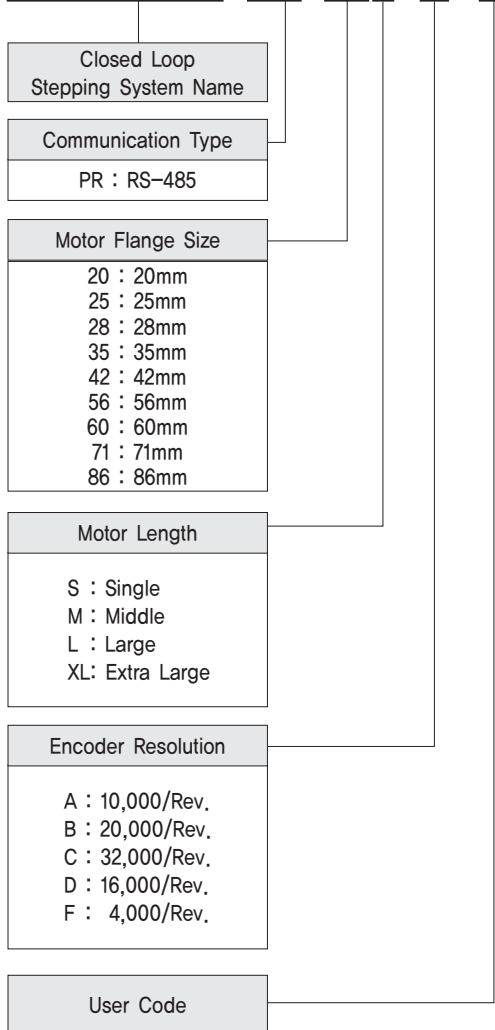

FASTECH Ezi-SERVO Plus-R

● Combination List of Ezi-SERVO Plus-R

Unit Part Number	Motor Model Number	Drive Model Number
Ezi-SERVO-PR-20M-F	EzM-20M-F	EzS-NDR-20M-F
Ezi-SERVO-PR-20L-F	EzM-20L-F	EzS-NDR-20L-F
Ezi-SERVO-PR-25S-F-L	EzM-25S-F-L	EzS-NDR-25S-F-L
Ezi-SERVO-PR-25M-F-L	EzM-25M-F-L	EzS-NDR-25M-F-L
Ezi-SERVO-PR-25L-F-L	EzM-25L-F-L	EzS-NDR-25L-F-L
Ezi-SERVO-PR-28S-D	EzM-28S-D	EzS-NDR-28S-D
Ezi-SERVO-PR-28M-D	EzM-28M-D	EzS-NDR-28M-D
Ezi-SERVO-PR-28L-D	EzM-28L-D	EzS-NDR-28L-D
Ezi-SERVO-PR-35S-D	EzM-35S-D	EzS-NDR-35S-D
Ezi-SERVO-PR-35M-D	EzM-35M-D	EzS-NDR-35M-D
Ezi-SERVO-PR-35L-D	EzM-35L-D	EzS-NDR-35L-D
Ezi-SERVO-PR-35XL-D	EzM-35XL-D	EzS-NDR-35XL-D
Ezi-SERVO-PR-42S-A	EzM-42S-A	EzS-NDR-42S-A
Ezi-SERVO-PR-42S-B	EzM-42S-B	EzS-NDR-42S-B
Ezi-SERVO-PR-42S-C	EzM-42S-C	EzS-NDR-42S-C
Ezi-SERVO-PR-42M-A	EzM-42M-A	EzS-NDR-42M-A
Ezi-SERVO-PR-42M-B	EzM-42M-B	EzS-NDR-42M-B
Ezi-SERVO-PR-42M-C	EzM-42M-C	EzS-NDR-42M-C
Ezi-SERVO-PR-42L-A	EzM-42L-A	EzS-NDR-42L-A
Ezi-SERVO-PR-42L-B	EzM-42L-B	EzS-NDR-42L-B
Ezi-SERVO-PR-42L-C	EzM-42L-C	EzS-NDR-42L-C
Ezi-SERVO-PR-42XL-A	EzM-42XL-A	EzS-NDR-42XL-A
Ezi-SERVO-PR-42XL-B	EzM-42XL-B	EzS-NDR-42XL-B
Ezi-SERVO-PR-42XL-C	EzM-42XL-C	EzS-NDR-42XL-C

● Combination List of Ezi-SERVO Plus-R

Unit Part Number	Motor Model Number	Drive Model Number
Ezi-SERVO-PR-56S-A	EzM-56S-A	EzS-NDR-56S-A
Ezi-SERVO-PR-56S-B	EzM-56S-B	EzS-NDR-56S-B
Ezi-SERVO-PR-56S-C	EzM-56S-C	EzS-NDR-56S-C
Ezi-SERVO-PR-56M-A	EzM-56M-A	EzS-NDR-56M-A
Ezi-SERVO-PR-56M-B	EzM-56M-B	EzS-NDR-56M-B
Ezi-SERVO-PR-56M-C	EzM-56M-C	EzS-NDR-56M-C
Ezi-SERVO-PR-56L-A	EzM-56L-A	EzS-NDR-56L-A
Ezi-SERVO-PR-56L-B	EzM-56L-B	EzS-NDR-56L-B
Ezi-SERVO-PR-56L-C	EzM-56L-C	EzS-NDR-56L-C
Ezi-SERVO-PR-56S-A-L	EzM-56S-A-L	EzS-NDR-56S-A-L
Ezi-SERVO-PR-56S-B-L	EzM-56S-B-L	EzS-NDR-56S-B-L
Ezi-SERVO-PR-56S-C-L	EzM-56S-C-L	EzS-NDR-56S-C-L
Ezi-SERVO-PR-56M-A-L	EzM-56M-A-L	EzS-NDR-56M-A-L
Ezi-SERVO-PR-56M-B-L	EzM-56M-B-L	EzS-NDR-56M-B-L
Ezi-SERVO-PR-56M-C-L	EzM-56M-C-L	EzS-NDR-56M-C-L
Ezi-SERVO-PR-56L-A-L	EzM-56L-A-L	EzS-NDR-56L-A-L
Ezi-SERVO-PR-56L-B-L	EzM-56L-B-L	EzS-NDR-56L-B-L
Ezi-SERVO-PR-56L-C-L	EzM-56L-C-L	EzS-NDR-56L-C-L
Ezi-SERVO-PR-60S-A	EzM-60S-A	EzS-NDR-60S-A
Ezi-SERVO-PR-60S-B	EzM-60S-B	EzS-NDR-60S-B
Ezi-SERVO-PR-60S-C	EzM-60S-C	EzS-NDR-60S-C
Ezi-SERVO-PR-60M-A	EzM-60M-A	EzS-NDR-60M-A
Ezi-SERVO-PR-60M-B	EzM-60M-B	EzS-NDR-60M-B
Ezi-SERVO-PR-60M-C	EzM-60M-C	EzS-NDR-60M-C
Ezi-SERVO-PR-60L-A	EzM-60L-A	EzS-NDR-60L-A
Ezi-SERVO-PR-60L-B	EzM-60L-B	EzS-NDR-60L-B
Ezi-SERVO-PR-60L-C	EzM-60L-C	EzS-NDR-60L-C
Ezi-SERVO-PR-71M-A-L	EzM-71M-A-L	EzS-NDR-71M-A-L
Ezi-SERVO-PR-71M-B-L	EzM-71M-B-L	EzS-NDR-71M-B-L
Ezi-SERVO-PR-71M-C-L	EzM-71M-C-L	EzS-NDR-71M-C-L
Ezi-SERVO-PR-71L-A-L	EzM-71L-A-L	EzS-NDR-71L-A-L
Ezi-SERVO-PR-71L-B-L	EzM-71L-B-L	EzS-NDR-71L-B-L
Ezi-SERVO-PR-71L-C-L	EzM-71L-C-L	EzS-NDR-71L-C-L
Ezi-SERVO-PR-86M-A	EzM-86M-A	EzS-NDR-86M-A
Ezi-SERVO-PR-86M-B	EzM-86M-B	EzS-NDR-86M-B
Ezi-SERVO-PR-86M-C	EzM-86M-C	EzS-NDR-86M-C
Ezi-SERVO-PR-86L-A	EzM-86L-A	EzS-NDR-86L-A
Ezi-SERVO-PR-86L-B	EzM-86L-B	EzS-NDR-86L-B
Ezi-SERVO-PR-86L-C	EzM-86L-C	EzS-NDR-86L-C
Ezi-SERVO-PR-86XL-A	EzM-86XL-A	EzS-NDR-86XL-A
Ezi-SERVO-PR-86XL-B	EzM-86XL-B	EzS-NDR-86XL-B
Ezi-SERVO-PR-86XL-C	EzM-86XL-C	EzS-NDR-86XL-C

● Advantages over Open-loop Control Stepping Drive

1. Reliable positioning without loss of synchronism.
2. Holding stable position and automatically recovering to the original position even after experiencing positioning error due to external forces, such as mechanical vibration or vertical positional holding.
3. Ezi-SERVO[®] utilizes 100% of the full range of rated motor torque, contrary to a conventional open-loop stepping driver that can use up to 50% of the rated motor torque due to the loss of synchronism.
4. Capability to operate at high speed due to load-dependant current control, open-loop stepper drivers use a constant current control at all speed ranges without considering load variations.

● Advantages over Servo Motor Controller

1. No gain tuning (Automatic adjustment of gain in response to a load change.)
2. Maintains the stable holding position without oscillation after completing positioning.
3. Fast positioning due to the independent control by on-board DSP.
4. Continuous operation during rapid short-stroke movement due to instantaneous positioning.

● Specifications

Motor Model	EzM-20 series	EzM-25 series	EzM-28 series	EzM-35 series	EzM-42 series	EzM-56 series	EzM-56 series	EzM-60 series	EzM-71 series	EzM-86 series
Driver Model	EzS-NDR-20 series	EzS-NDR-25 series	EzS-NDR-28 series	EzS-NDR-35 series	EzS-NDR-42 series	EzS-NDR-56 series	EzS-NDR-56 series	EzS-NDR-60 series	EzS-NDR-71 series	EzS-NDR-86 series
Input Voltage	24VDC \pm 10%									40~70VDC
Control Method	Closed loop control with 32bit DSP									
Multi Axes Drive	Maximum 16 axes through Daisy-Chain									
Position Table	256 motion command steps (Continuous, Wait, Loop, Jump and External start etc.)									
Current Consumption	Max 500mA (Except motor current)									
Operating Condition	Ambient Temperature	In Use : 0~50°C In Storage : -20~70°C								
	Humidity	In Use : 35~85% (Non-condensing) In Storage : 10~90% (Non-condensing)								
	Vib. Resist.	0.5G								
Function	Rotation Speed	0~3,000rpm								
	Resolution(P/R)	4,000/Rev. Encoder model : 500 1,000 1,600 2,000 3,600 5,000 6,400 7,200 10,000 4,000 10,000/Rev. Encoder model : 500 1,000 1,600 2,000 3,600 5,000 6,400 7,200 10,000 16,000/Rev. Encoder model : 500 1,000 1,600 2,000 3,600 5,000 6,400 7,200 10,000 16,000 20,000/Rev. Encoder model : 500 1,000 1,600 2,000 3,600 5,000 6,400 7,200 10,000 20,000 32,000/Rev. Encoder model : 500 1,000 1,600 2,000 3,600 5,000 6,400 7,200 10,000 32,000								
	Protection Functions	Over current, Over speed, Position tracking error, Over load, Over temperature, Over regenerated voltage, Motor connect error, Encoder connect error, Motor voltage error, In-Position error, System error, ROM error, Input voltage error, Position overflow error								
	LED Display	Power status, Alarm status, In-Position status, Servo On status								
	In-Position Selection	0~15 (Selectable by parameter)								
	Position Gain Selection	0~15 (Selectable by parameter)								
	Rotational Direction	CW / CCW (Selectable by parameter)								
	I/O Signal	Input Signal	3 dedicated input (LIMIT+, LIMIT-, ORIGIN), 9 programmable input (Photocoupler)							
Output Signal		1 dedicated output (Compare Out), 9 programmable output (Photocoupler), Brake signal								
Communication Interface	The RS-485 serial communication with PC Transmission speed : 9,600~921,600bps									
Position Control	Incremental mode / Absolute mode Data Range : -134,217,727 to +134,217,727pulse, Operating speed : Max. 3,000rpm									
Return to Origin	Origin Sensor, Z phase, \pm Limit sensor, Torque									
GUI	User Interface Program within Windows									
Software	Motion Library (DLL) for windows 2000/XP									

● Drive Dimension [mm]

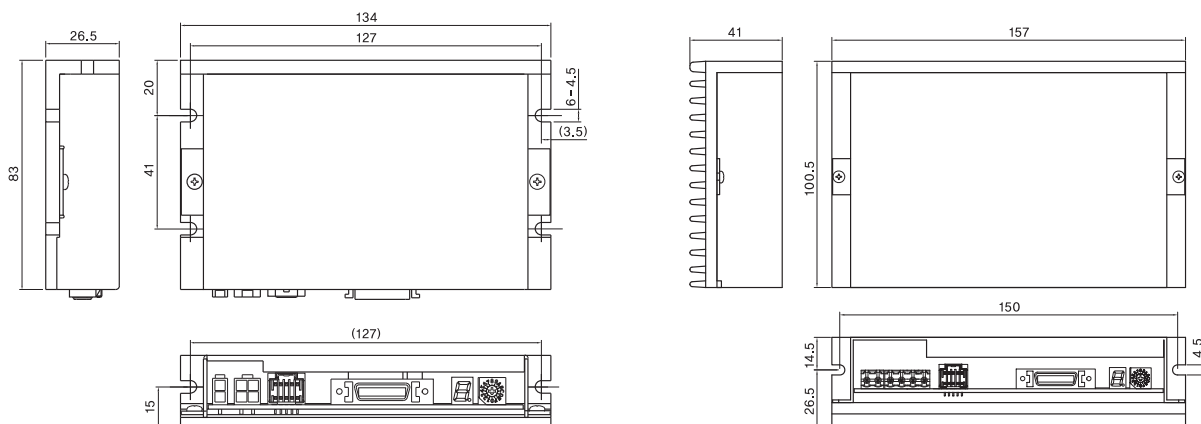

※Only for 86mm motor drive (EzS-NDR-86 series)

● Motor Specifications

MODEL		UNIT	EzM-20M-F	EzM-20L-F
DRIVE METHOD		----	BI-POLAR	BI-POLAR
NUMBER OF PHASES		----	2	2
VOLTAGE		VDC	2,9	3,25
CURRENT per PHASE		A	0,5	0,5
RESISTANCE per PHASE		Ohm	5,8	6,5
INDUCTANCE per PHASE		mH	2,5	5
HOLDING TORQUE		N · m	0,013	0,025
ROTOR INERTIA		$g \cdot \text{cm}^2$	2,5	5
WEIGHTS		g	50	80
LENGTH (L)		mm	28	38
ALLOWABLE OVERHUNG LOAD (DISTANCE FROM END OF SHAFT)	3mm	N	18	18
	8mm		30	30
ALLOWABLE THRUST LOAD		N	Lower than motor weight	
INSULATION RESISTANCE		MOhm	100min. (at 500VDC)	
INSULATION CLASS		----	CLASS B (130°C)	
OPERATING TEMPERATURE		°C	0 to 55	

● Motor Dimension [mm] and Torque Characteristics

FASTECH Ezi-SERVO Plus-R

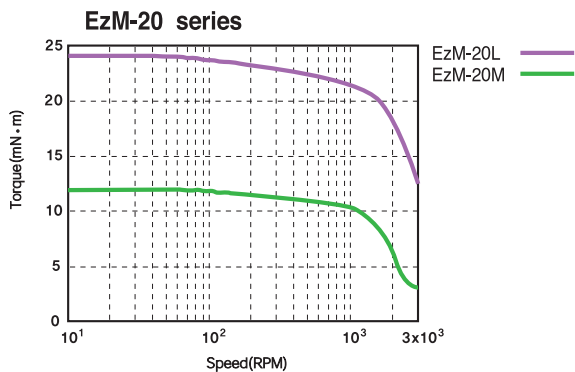
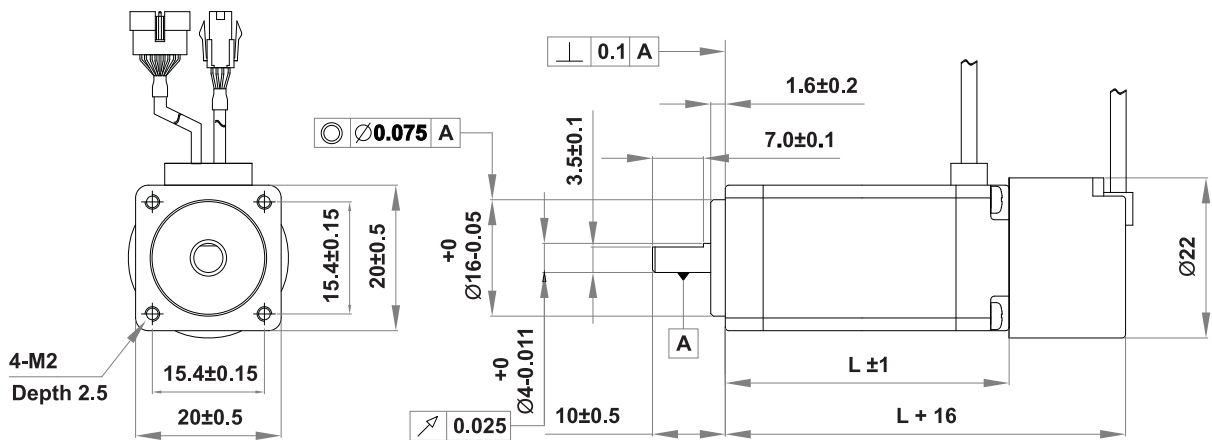

※ Measured Condition

- Motor Voltage = 24VDC
- Motor Current = Rated Current (Refer to Motor Specification)
- Drive = Ezi-SERVO-Plus R

● Motor Specifications

M O D E L		UNIT	EzM-25S-F-L	EzM-25M-F-L	EzM-25L-F-L
DRIVE METHOD		----	BI-POLAR	BI-POLAR	BI-POLAR
NUMBER OF PHASES		----	2	2	2
VOLTAGE		VDC	2,66	9,87	3,654
CURRENT per PHASE		A	0,7	0,21	0,63
RESISTANCE per PHASE		Ohm	3,8	47	5,8
INDUCTANCE per PHASE		mH	2,0	30	5,4
HOLDING TORQUE		N · m	0,033	0,049	0,062
ROTOR INERTIA		$g \cdot \text{cm}^2$	2	3	7
WEIGHTS		g	85	100	120
LENGTH (L)		mm	23,5	27,5	33
ALLOWABLE OVERHUNG LOAD (DISTANCE FROM END OF SHAFT)	3mm	N	30	30	30
	8mm		38	38	38
ALLOWABLE THRUST LOAD		N	Lower than motor weight		
INSULATION RESISTANCE		MOhm	100min. (at 500VDC)		
INSULATION CLASS		----	CLASS B (130°C)		
OPERATING TEMPERATURE		°C	0 to 55		

● Motor Dimension [mm] and Torque Characteristics

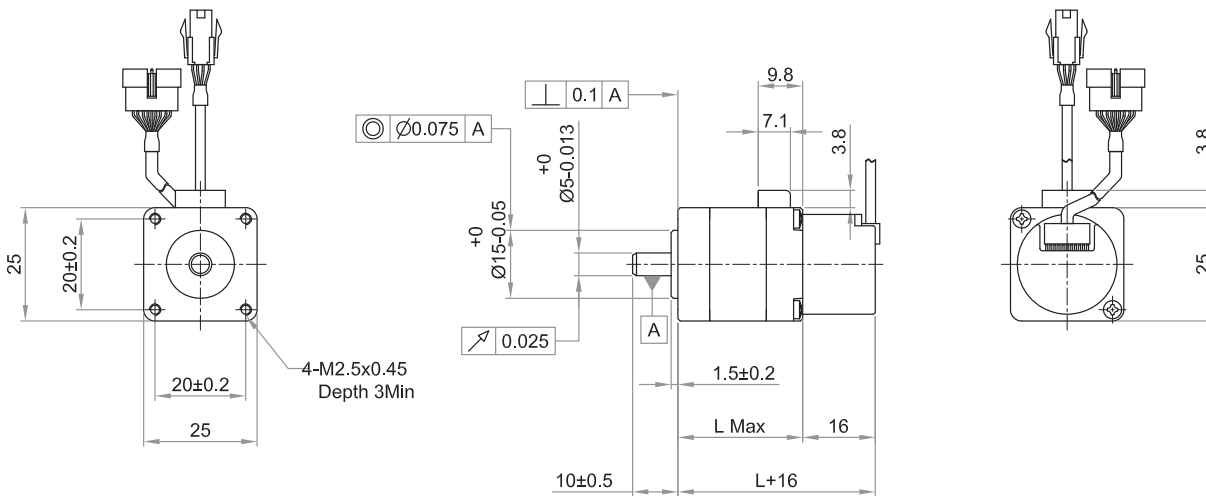

FASTECH Ezi-SERVO Plus-R

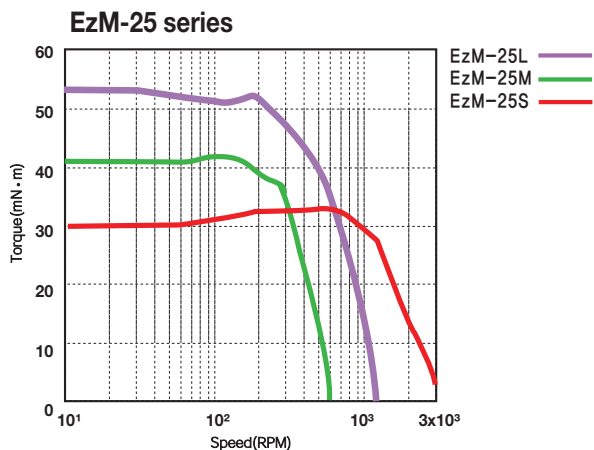

※ Measured Condition

Motor Voltage = 24VDC

Motor Current = Rated Current (Refer to Motor Specification)

Drive = Ezi-SERVO-Plus R

● Motor Specifications

MODEL		UNIT	EzM-28S-D	EzM-28M-D	EzM-28L-D
DRIVE METHOD		----	BI-POLAR	BI-POLAR	BI-POLAR
NUMBER OF PHASES		----	2	2	2
VOLTAGE		VDC	3.04	3.04	3.42
CURRENT per PHASE		A	0.95	0.95	0.95
RESISTANCE per PHASE		Ohm	3.2	3.2	3.6
INDUCTANCE per PHASE		mH	2	5	5.8
HOLDING TORQUE		N · m	0.065	0.08	0.11
ROTOR INERTIA		g · cm ²	9	13	18
WEIGHTS		g	110	140	200
LENGTH (L)		mm	32	45	52
ALLOWABLE OVERHUNG LOAD (DISTANCE FROM END OF SHAFT)	3mm	N	30	30	30
	8mm		38	38	38
	13mm		53	53	53
ALLOWABLE THRUST LOAD		N	Lower than motor weight		
INSULATION RESISTANCE		MOhm	100min, (at 500VDC)		
INSULATION CLASS		----	CLASS B (130°C)		
OPERATING TEMPERATURE		°C	0 to 55		

● Motor Dimension [mm] and Torque Characteristics

FASTECH Ezi-SERVO Plus-R

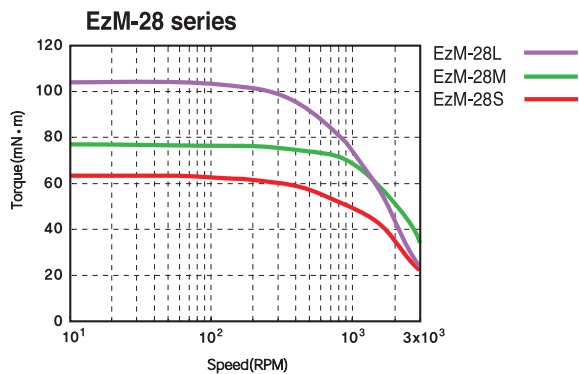
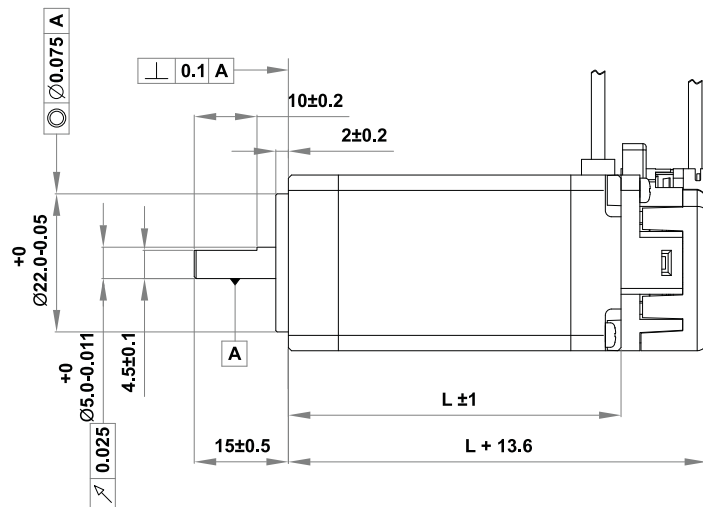
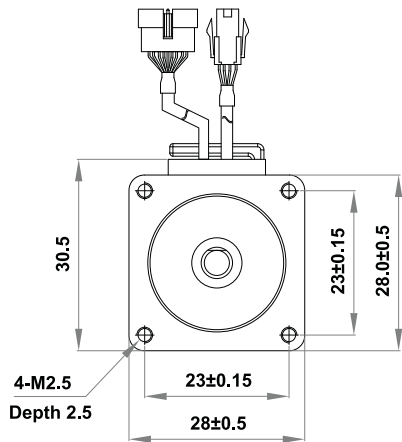

※ Measured Condition

Motor Voltage = 24VDC
 Motor Current = Rated Current (Refer to Motor Specification)
 Drive = Ezi-SERVO-Plus R

● Motor Specifications

MODEL		UNIT	EzM-35S-D	EzM-35M-D	EzM-35L-D	EzM-35XL-D
DRIVE METHOD		----	BI-POLAR			
NUMBER OF PHASES		----	2			
VOLTAGE		VDC	2,28	2,88	4,59	5,39
CURRENT per PHASE		A	0,6	0,6	0,85	0,7
RESISTANCE per PHASE		Ohm	3,8	4,8	5,4	7,7
INDUCTANCE per PHASE		mH	3,2	6,1	6,5	8,4
HOLDING TORQUE		N · m	0,034	0,050	0,176	0,225
ROTOR INERTIA		g · cm ²	5	8	11	32
WEIGHTS		g	165	180	260	360
LENGTH (L)		mm	22	26	38	53
ALLOWABLE OVERHUNG LOAD (DISTANCE FROM END OF SHAFT)	3mm	N	22	22	22	22
	8mm		26	26	26	26
	13mm		33	33	33	33
	18mm		46	46	46	46
ALLOWABLE THRUST LOAD		N	Lower than motor weight			
INSULATION RESISTANCE		MOhm	100min, (at 500VDC)			
INSULATION CLASS		----	CLASS B (130°C)			
OPERATING TEMPERATURE		°C	0 to 55			

● Motor Dimension [mm] and Torque Characteristics

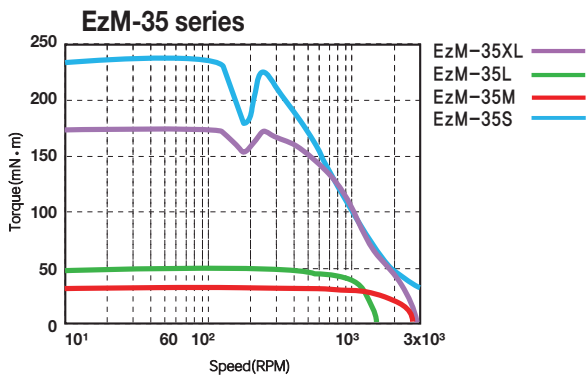
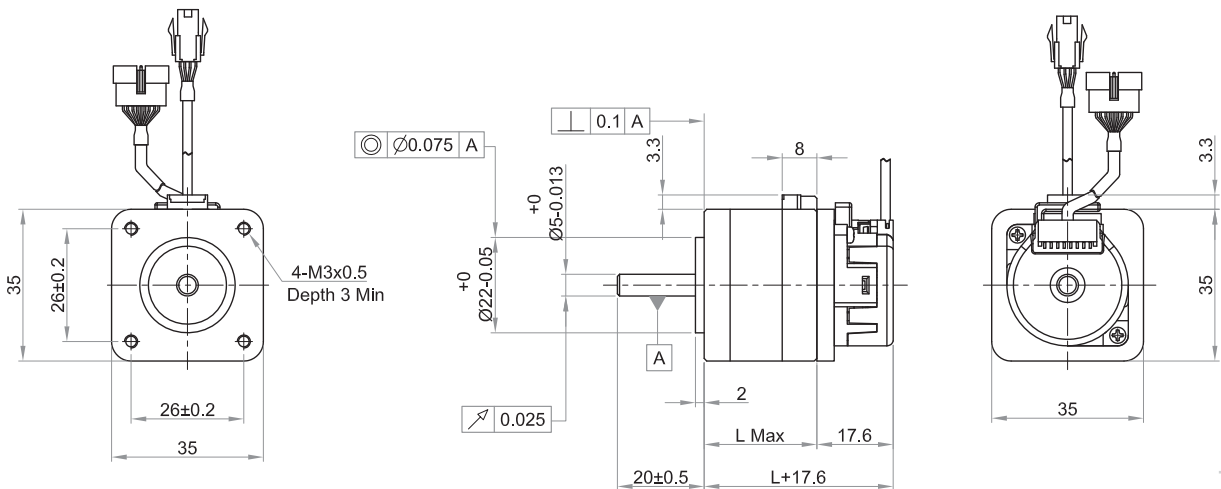

※ Measured Condition

Motor Voltage = 24VDC
 Motor Current = Rated Current (Refer to Motor Specification)
 Drive = Ezi-SERVO-Plus R

● Motor Specifications

M O D E L	UNIT	EzM-42S-A	EzM-42M-A	EzM-42L-A	EzM-42XL-A	
		EzM-42S-B	EzM-42M-B	EzM-42L-B	EzM-42XL-B	
		EzM-42S-C	EzM-42M-C	EzM-42L-C	EzM-42XL-C	
DRIVE METHOD	----	BI-POLAR	BI-POLAR	BI-POLAR	BI-POLAR	
NUMBER OF PHASES	----	2	2	2	2	
VOLTAGE	VDC	3,36	4,32	4,56	7,2	
CURRENT per PHASE	A	1,2	1,2	1,2	1,2	
RESISTANCE per PHASE	Ohm	2,8	3,6	3,8	6	
INDUCTANCE per PHASE	mH	2,5	7,2	8	15,6	
HOLDING TORQUE	N · m	0,32	0,44	0,5	0,65	
ROTOR INERTIA	g · cm ²	35	54	77	114	
WEIGHTS	g	220	280	350	500	
LENGTH (L)	mm	33	39	47	59	
ALLOWABLE OVERHUNG LOAD (DISTANCE FROM END OF SHAFT)	3mm	N	22	22	22	22
	8mm		26	26	26	26
	13mm		33	33	33	33
	18mm		46	46	46	46
ALLOWABLE THRUST LOAD	N	Lower than motor weight				
INSULATION RESISTANCE	MOhm	100min. (at 500VDC)				
INSULATION CLASS	----	CLASS B (130°C)				
OPERATING TEMPERATURE	°C	0 to 55				

● Motor Dimension [mm] and Torque Characteristics

FASTECH Ezi-SERVO Plus-R

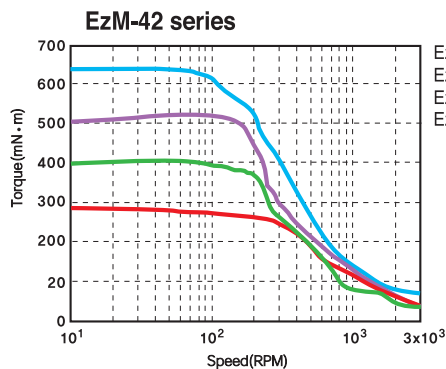
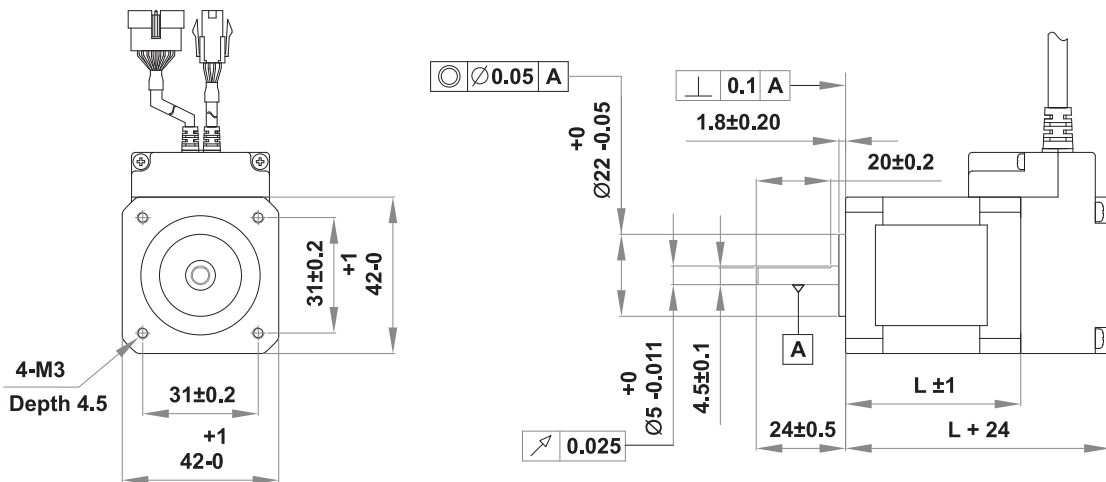

※ Measured Condition

Motor Voltage = 24VDC
 Motor Current = Rated Current (Refer to Motor Specification)
 Drive = Ezi-SERVO-Plus R

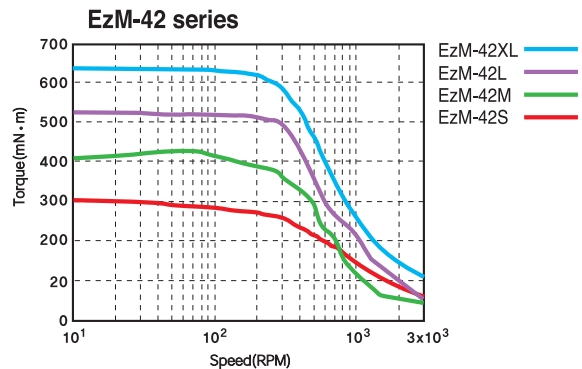

※ Measured Condition

Motor Voltage = 40VDC
 Motor Current = Rated Current (Refer to Motor Specification)
 Drive = Ezi-SERVO-Plus R

● Motor Specifications

MODEL	UNIT	EzM-56S-A EzM-56S-B EzM-56S-C	EzM-56M-A EzM-56M-B EzM-56M-C	EzM-56L-A EzM-56L-B EzM-56L-C
DRIVE METHOD	----	BI-POLAR	BI-POLAR	BI-POLAR
NUMBER OF PHASES	----	2	2	2
VOLTAGE	VDC	1,56	2,1	2,7
CURRENT per PHASE	A	3	3	3
RESISTANCE per PHASE	Ohm	0,52	0,54	0,9
INDUCTANCE per PHASE	mH	1	2	3,8
HOLDING TORQUE	N · m	0,64	1	1,5
ROTOR INERTIA	g · cm ²	120	200	480
WEIGHTS	g	500	700	1150
LENGTH (L)	mm	46	54	80
ALLOWABLE OVERHUNG LOAD (DISTANCE FROM END OF SHAFT)	3mm	52	52	52
	8mm	65	65	65
	13mm	85	85	85
	18mm	123	123	123
ALLOWABLE THRUST LOAD	N	Lower than motor weight		
INSULATION RESISTANCE	MOhm	100min. (at 500VDC)		
INSULATION CLASS	----	CLASS B (130°C)		
OPERATING TEMPERATURE	°C	0 to 55		

● Motor Dimension [mm] and Torque Characteristics

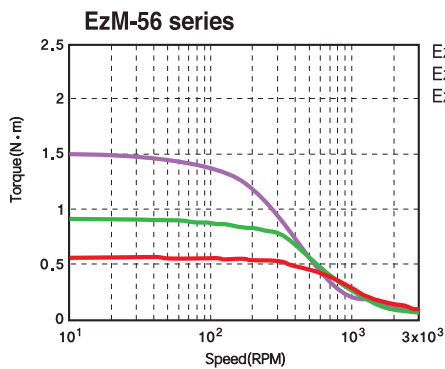
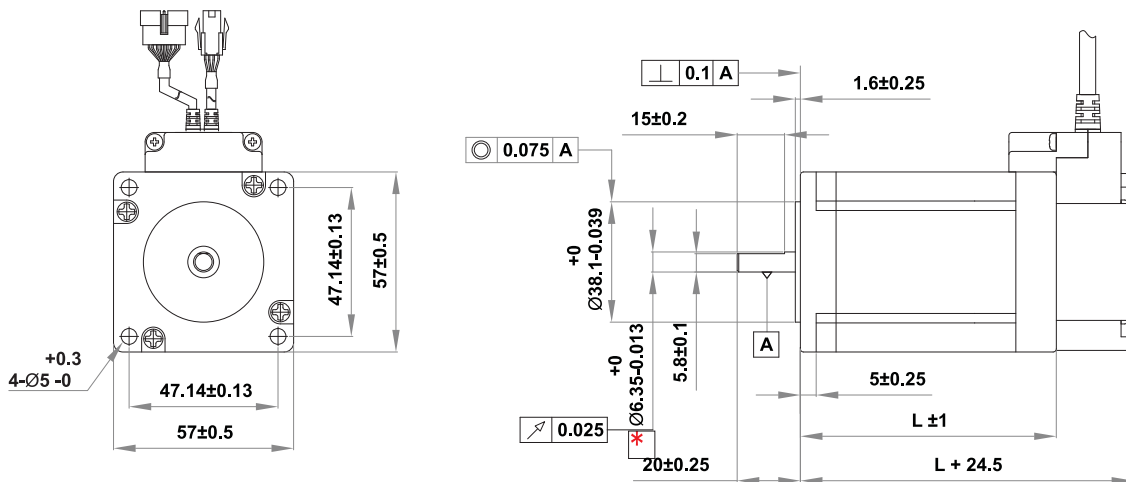

※ Measured Condition
 Motor Voltage = 24VDC
 Motor Current = Rated Current (Refer to Motor Specification)
 Drive = Ezi-SERVO-Plus R

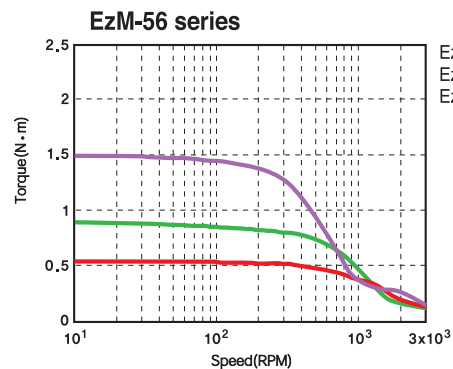

※ Measured Condition
 Motor Voltage = 40VDC
 Motor Current = Rated Current (Refer to Motor Specification)
 Drive = Ezi-SERVO-Plus R

* : There are 2 kinds size of front shaft diameter for EzM-56 series as $\Phi 6,35$ and $\Phi 8,0$.

● Motor Specifications

MODEL		UNIT	EzM-56S-A-L EzM-56S-B-L EzM-56S-C-L	EzM-56M-A-L EzM-56M-B-L EzM-56M-C-L	EzM-56L-A-L EzM-56L-B-L EzM-56L-C-L
DRIVE METHOD		----	BI-POLAR	BI-POLAR	BI-POLAR
NUMBER OF PHASES		----	2	2	2
VOLTAGE		VDC	3,36	3,74	4,6
CURRENT per PHASE		A	1,4	2,2	2
RESISTANCE per PHASE		Ohm	2,4	1,7	2,3
INDUCTANCE per PHASE		mH	7,7	7,2	10,6
HOLDING TORQUE		N · m	0,54	1,0	1,5
ROTOR INERTIA		g · cm ²	120	200	360
WEIGHTS		g	540	750	1120
LENGTH (L)		mm	42	54	76
ALLOWABLE OVERHUNG LOAD (DISTANCE FROM END OF SHAFT)	3mm	N	52	52	52
	8mm		65	65	65
	13mm		85	85	85
	18mm		123	123	123
ALLOWABLE THRUST LOAD		N	Lower than motor weight		
INSULATION RESISTANCE		MOhm	100min. (at 500VDC)		
INSULATION CLASS		----	CLASS B (130°C)		
OPERATING TEMPERATURE		°C	0 to 55		

● Motor Dimension [mm] and Torque Characteristics

FASTECH Ezi-SERVO Plus-R

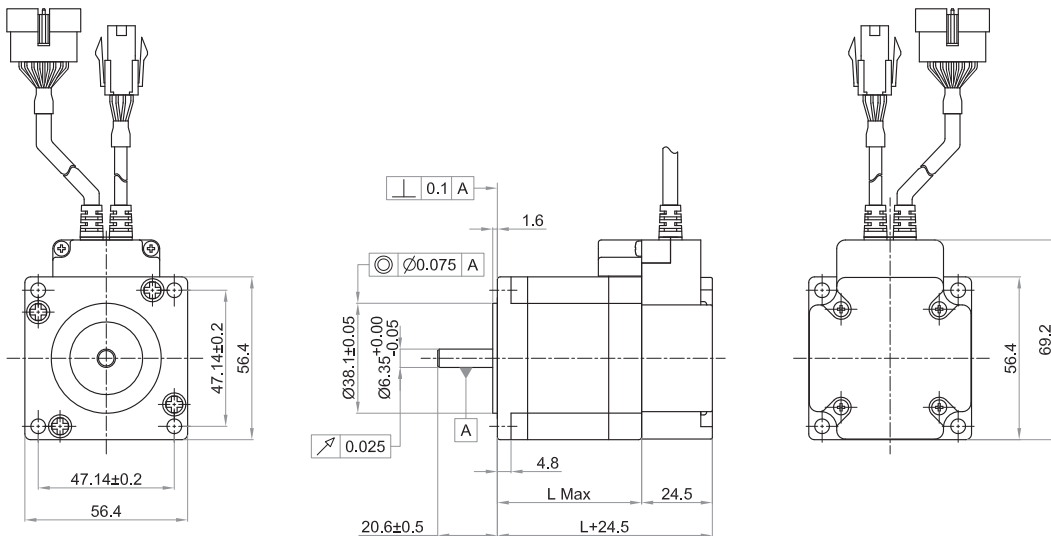

Low Vibration EzM-56 series

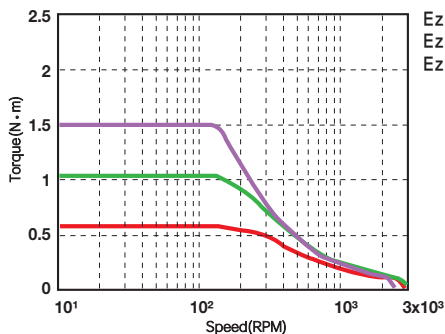

※ Measured Condition

Motor Voltage = 24VDC
 Motor Current = Rated Current (Refer to Motor Specification)
 Drive = Ezi-SERVO-Plus R

Low Vibration EzM-56 series

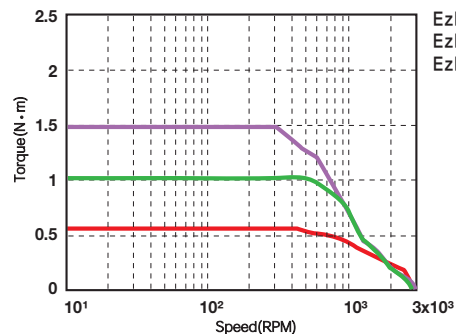

※ Measured Condition

Motor Voltage = 40VDC
 Motor Current = Rated Current (Refer to Motor Specification)
 Drive = Ezi-SERVO-Plus R

● Motor Specifications

M O D E L		UNIT	EzM-60S-A EzM-60S-B EzM-60S-C	EzM-60M-A EzM-60M-B EzM-60M-C	EzM-60L-A EzM-60L-B EzM-60L-C
DRIVE METHOD		----	BI-POLAR	BI-POLAR	BI-POLAR
NUMBER OF PHASES		----	2	2	2
VOLTAGE		VDC	1,52	1,56	2,6
CURRENT per PHASE		A	4	4	4
RESISTANCE per PHASE		Ohm	0,38	0,39	0,65
INDUCTANCE per PHASE		mH	0,64	1,2	2,4
HOLDING TORQUE		N · m	0,88	1,28	2,4
ROTOR INERTIA		g · cm ²	140	320	800
WEIGHTS		g	600	900	1600
LENGTH (L)		mm	46	56	90
ALLOWABLE OVERHUNG LOAD (DISTANCE FROM END OF SHAFT)	3mm	N	70	70	70
	8mm		87	87	87
	13mm		114	114	114
	18mm		165	165	165
ALLOWABLE THRUST LOAD		N	Lower than motor weight		
INSULATION RESISTANCE		MOhm	100min, (at 500VDC)		
INSULATION CLASS		----	CLASS B (130°C)		
OPERATING TEMPERATURE		°C	0 to 55		

● Motor Dimension [mm] and Torque Characteristics

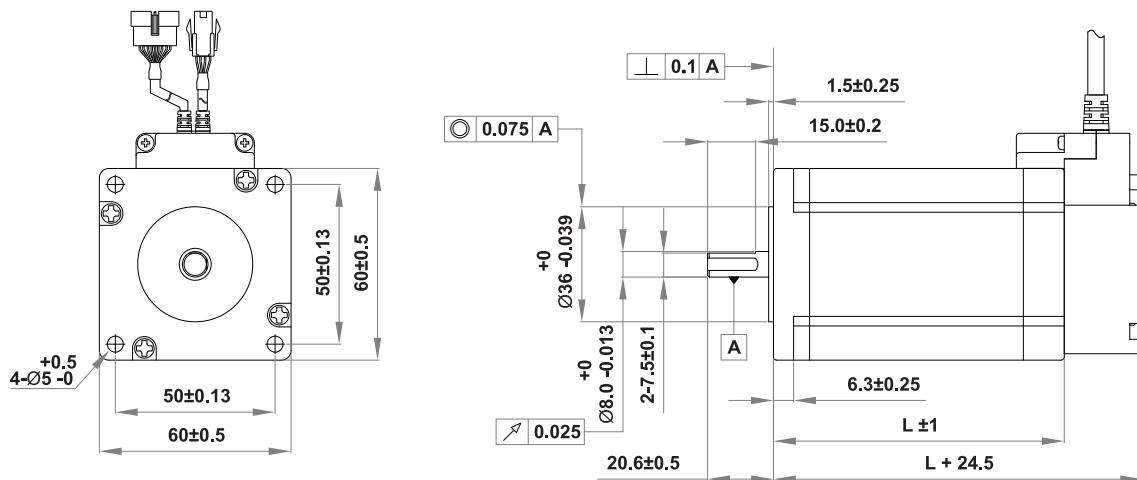

FASTECH Ezi-SERVO Plus-R

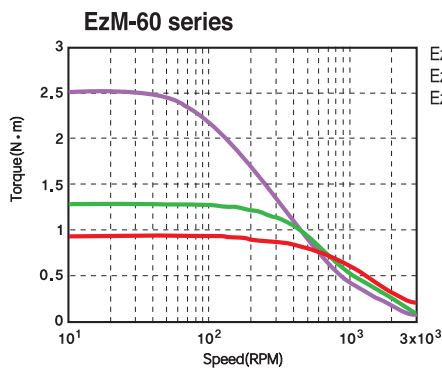

※ Measured Condition

Motor Voltage = 24VDC
 Motor Current = Rated Current(Refer to Motor Specification)
 Drive = Ezi-SERVO-Plus R

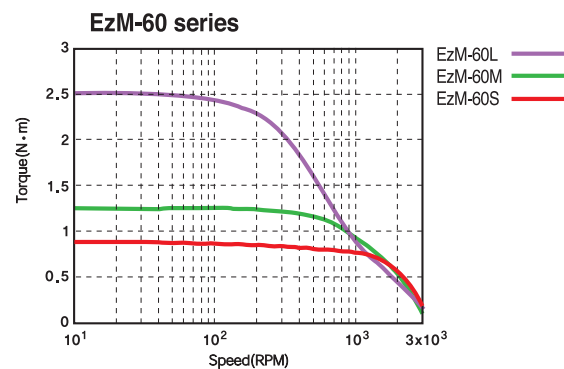

※ Measured Condition

Motor Voltage = 40VDC
 Motor Current = Rated Current(Refer to Motor Specification)
 Drive = Ezi-SERVO-Plus R

● Motor Specifications

M O D E L		UNIT	EzM-71M-A-L EzM-71M-B-L EzM-71M-C-L	EzM-71L-A-L EzM-71L-B-L EzM-71L-C-L
DRIVE METHOD		----	BI-POLAR	BI-POLAR
NUMBER OF PHASES		----	2	2
VOLTAGE		VDC	4,68	4,4
CURRENT per PHASE		A	1,3	2,2
RESISTANCE per PHASE		Ohm	3,6	2
INDUCTANCE per PHASE		mH	11	8,3
HOLDING TORQUE		N · m	1,1	2,1
ROTOR INERTIA		g · cm ²	330	660
WEIGHTS		g	880	1450
LENGTH (L)		mm	51,5	77,5
ALLOWABLE OVERHUNG LOAD (DISTANCE FROM END OF SHAFT)	3mm	N	70	70
	8mm		87	87
	13mm		114	114
	18mm		165	165
ALLOWABLE THRUST LOAD		N	Lower than motor weight	
INSULATION RESISTANCE		MOhm	100min. (at 500VDC)	
INSULATION CLASS		----	CLASS B (130°C)	
OPERATING TEMPERATURE		°C	0 to 55	

● Motor Dimension [mm] and Torque Characteristics

FASTECH Ezi-SERVO Plus-R

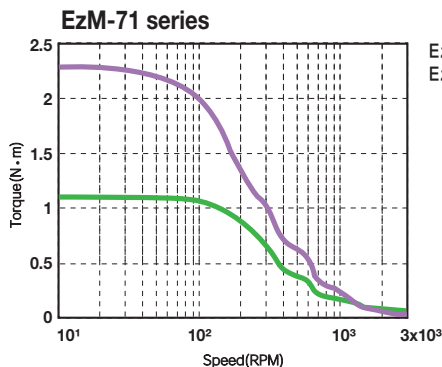
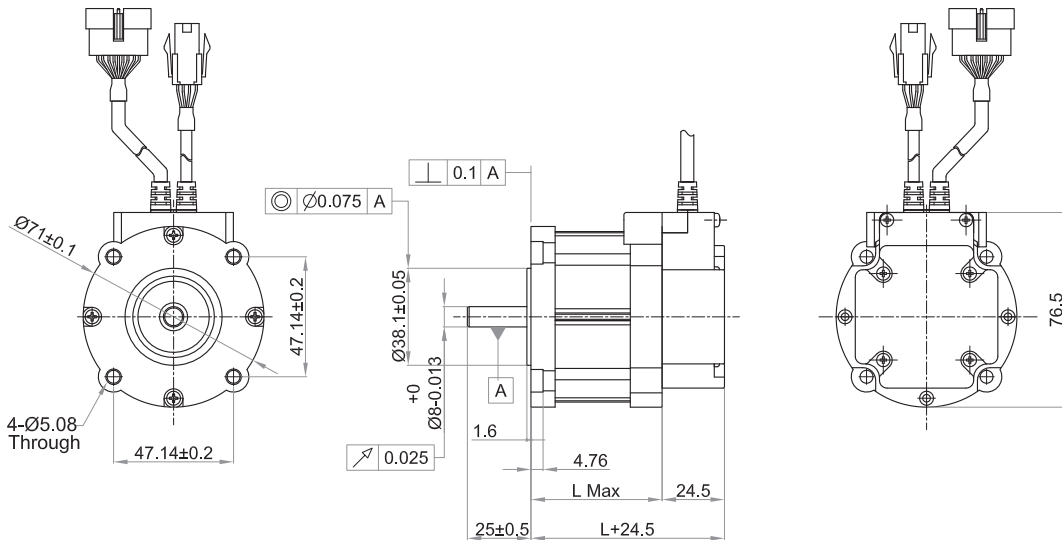

※ Measured Condition

Motor Voltage = 24VDC
 Motor Current = Rated Current(Refer to Motor Specification)
 Drive = Ezi-SERVO-Plus R

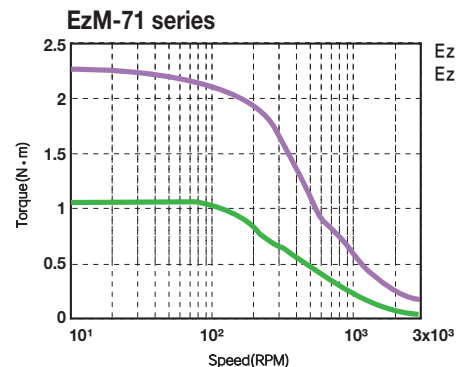

※ Measured Condition

Motor Voltage = 40VDC
 Motor Current = Rated Current(Refer to Motor Specification)
 Drive = Ezi-SERVO-Plus R

● Motor Specifications

MODEL		UNIT	EzM-86M-A	EzM-86L-A	EzM-86XL-A
DRIVE METHOD		----	BI-POLAR	BI-POLAR	BI-POLAR
NUMBER OF PHASES		----	2	2	2
VOLTAGE		VDC	2.4	3.6	4.38
CURRENT per PHASE		A	6	6	6
RESISTANCE per PHASE		Ohm	0.4	0.6	0.73
INDUCTANCE per PHASE		mH	3.5	6.5	8.68
HOLDING TORQUE		N · m	4.0	7.5	9.0
ROTOR INERTIA		g · cm ²	1400	2700	4000
WEIGHTS		Kg	2.3	3.8	5.3
LENGTH (L)		mm	79	117	155
ALLOWABLE OVERHUNG LOAD (DISTANCE FROM END OF SHAFT)	3mm	N	270	270	270
	8mm		300	300	300
	13mm		350	350	350
	18mm		400	400	400
ALLOWABLE THRUST LOAD		N	Lower than motor weight		
INSULATION RESISTANCE		MOhm	100min, (at 500VDC)		
INSULATION CLASS		----	CLASS B (130°C)		
OPERATING TEMPERATURE		°C	0 to 55		

● Motor Dimension [mm] and Torque Characteristics

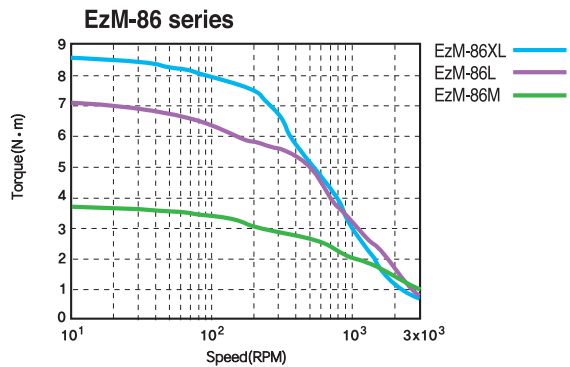
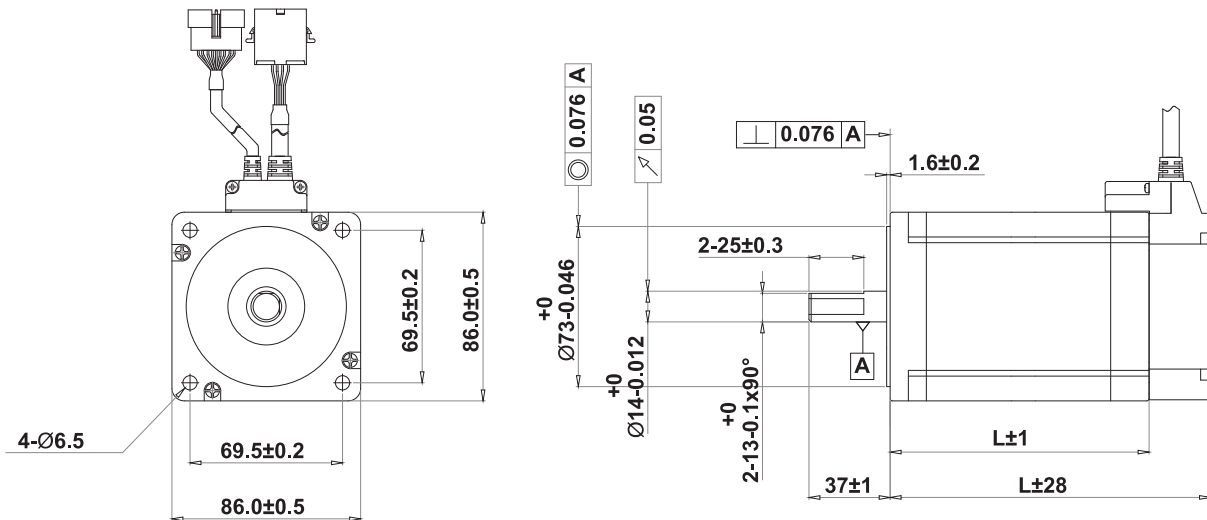

※ Measured Condition

Motor Voltage = 70VDC
 Motor Current = Rated Current(Refer to Motor Specification)
 Drive = Ezi-SERVO-Plus R

● Setting and Operating

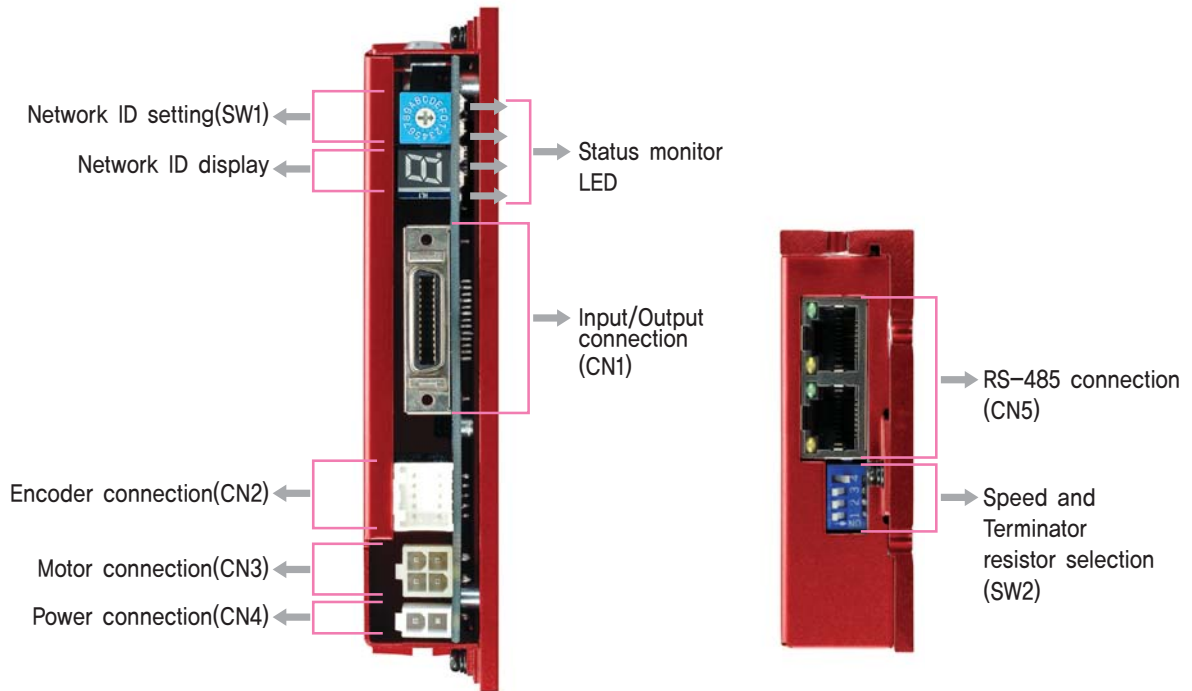

◆ 86mm motor drive only(EzS-NDR-86 Series)

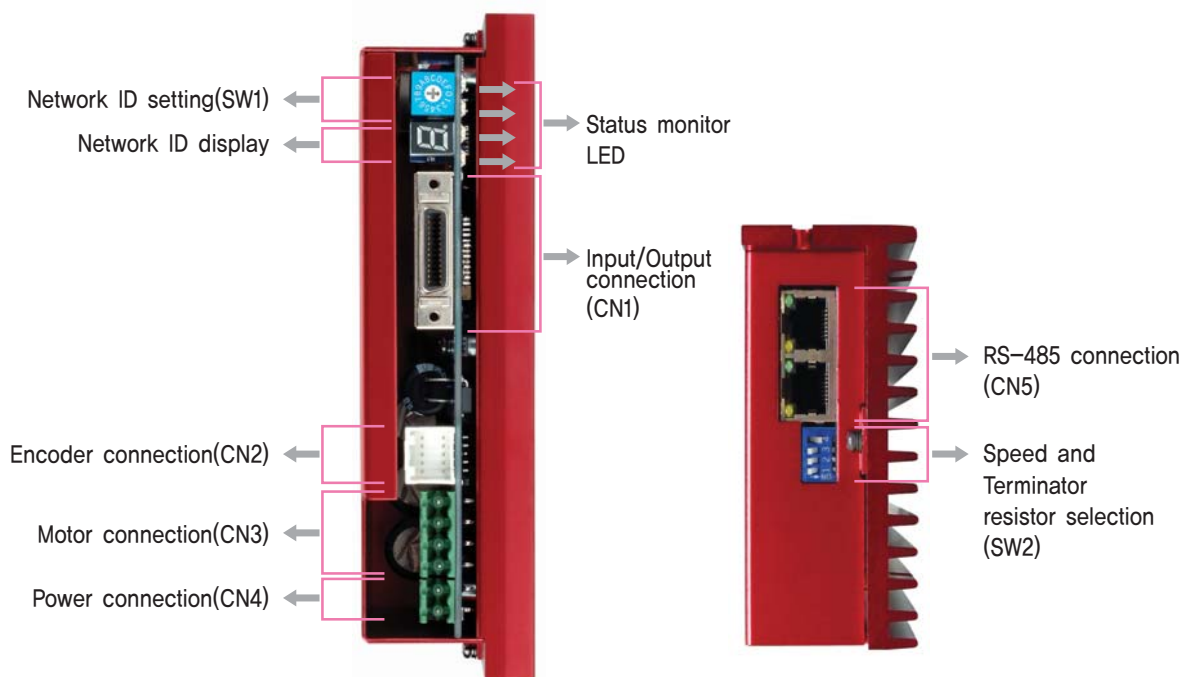

1. Status Monitor LED

Indication	Color	Function	ON/OFF Condition
PWR	Green	Power input indication	LED is turned ON when power is applied
INP	Yellow	Complete Positioning Motion	Lights On when Positioning error reaches within the preset pulse selected by rotary switch
SON	Orange	Servo On / Off Indication	Servo On : Lights On, Servo Off : Lights Off
ALM	Red	Alarm indication	Flash when protection function is activated (Identifiable which protection mode is activated by counting the blinking times)

◆ Protection functions and LED flash times

Times	Protection	Conditions
1	Over current	The current through power devices in inverter exceeds the limit value
2	Over speed	Motor speed exceed 3,000rpm
3	Position tracking error	Position error value is higher than 90° in motor run state*1
4	Over load	The motor is continuously operated more than 5 second under a load exceeding the max. torque
5	Over temperature	Inside temperature of drive exceeds 55°C
6	Over regenerated voltage	Back-EMF more high limit value*2
7	Motor connect error	The power is ON without connection of the motor cable to drive
8	Encoder connect error	Cable connection error with Encoder connector in drive
9	Motor voltage error	Motor voltage is out of limited value*3
10	In-Position error	After operation is finished, a position error occurs
11	System error	Error occurs in drive system
12	ROM error	Error occurs in parameter storage device(ROM)
14	Input voltage error	Power source voltage is out of limited value*4
15	Position overflow error	Position error value is higher than 90° in motor stop state*1

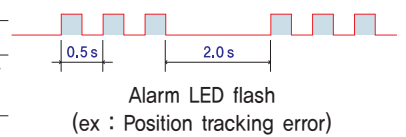

- *1 : 주어진 값은 파라미터에 의해 변경 가능합니다. (메뉴얼 참조)
- *2 : Voltage limit of Back-EMF depends on motor model (Refer to the Manual)
- *3 : Motor limit voltage value depends on motor model (Refer to the Manual)
- *4 : Limit value provided to drives depends on driver model (Refer to the Manual)

2. Network ID selection switch(SW1)

Position	ID number	Position	ID number
0	0	8	8
1	1	9	9
2	2	A	10
3	3	B	11
4	4	C	12
5	5	D	13
6	6	E	14
7	7	F	15



※Maximum 16 axis can be connected in one network.

3. Speed and Terminator resistor selection switch(SW2)

The purpose of this is to setting the communication speed and connect a terminator resistor if drive is installed at the end of network.

SW 2.1 used for connecting the terminator resistor.
SW 2.2~SW 2.4 used for setting speed as follows.

SW 2.1	SW 2.2	SW 2.3	SW 2.4	Baud rate[bps]
–	OFF	OFF	OFF	9,600
–	ON	OFF	OFF	19,200
–	OFF	ON	OFF	38,400
–	ON	ON	OFF	57,600
–	OFF	OFF	ON	115,200*1
–	ON	OFF	ON	230,400
–	OFF	ON	ON	460,800
–	ON	ON	ON	921,600

*1 : Default setting value

If SW2.1 is OFF, terminator resistor is disconnected.
If SW2.2 is ON, terminator resistor is connected.

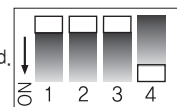

4. Input/Output signal(CN1)

NO.	Function	I/O
1	LIMIT+	Input
2	LIMIT-	Input
3	ORIGIN	Input
4	Digital In1	Input
5	Digital In6	Input
6	Digital In7	Input
7	Compare Out1	Output
8	Digital Out1	Output
9	Digital Out2	Output
10	Digital Out3	Output
11	Digital Out4	Output
12	Digital Out5	Output
13	Digital Out6	Output
14	Digital In2	Input
15	Digital In3	Input
16	Digital In4	Input
17	Digital In5	Input
18	Digital In8	Input
19	Digital In9	Input
20	Digital Out7	Output
21	Digital Out8	Output
22	Digital Out9	Output
23	BRAKE+	Output
24	BRAKE-	Output
25	24VDC GND	Input
26	24VDC	Input

※BRAKE function is optional.
 ※There is no BRAKE function for 86mm motor drive.

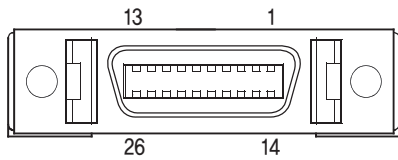

5. Encoder connector(CN2)

NO.	Function	I/O
1	A+	Input
2	A-	Input
3	B+	Input
4	B-	Input
5	Z+	Input
6	Z-	Input
7	5VDC	Output
8	5VDC GND	Output
9	Frame GND	----
10	Frame GND	----

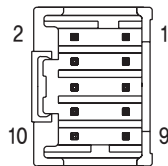

6. Motor connector(CN3)

NO.	Function
1	A Phase
2	B Phase
3	/A Phase
4	/B Phase



NO.	Function
1	/B Phase
2	B Phase
3	/A Phase
4	A Phase

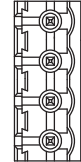

※Only for 86mm motor drive.

7. Power connector(CN4)

NO.	Function
1	24VDC ±10%
2	GND



NO.	Function
1	GND
2	40~70VDC

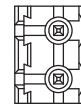

※Only for 86mm motor drive.

8. RS-485 Communication connector(CN5)

There is converter for connecting PC.

1)RS-232 to RS-485

NO.	Function	NO.	Function
1	GND	6	Data-
2	GND	7	GND
3	Data+	8	GND
4	GND	LED 1, 3	Drive status
5	GND	LED 2, 4	Communication status

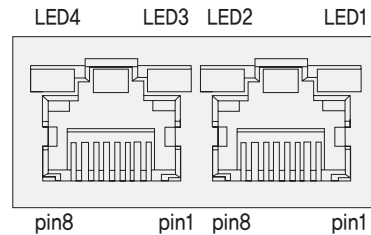

◆ Connector for Cabling

These connectors are serviced together with Ezi-SERVO Plus-R except when purchasing option cables.

CN1 : Input/Output Connector

Item	Specification	Maker
Connector	10126-3000PE	3M
Shell	10326-52FO-008	3M

CN2 : Encoder Connector

Item	Specification	Maker
Housing	51353-1000	MOLEX
Terminal	56134-9000	MOLEX

CN3 : Motor Connector

Item	Specification	Maker
Housing	5557-04R	MOLEX
Terminal	5556T	MOLEX

CN4 : Power Connector

Item	Specification	Maker
Housing	5557-02R	MOLEX
Terminal	5556T	MOLEX

CN3 : Motor Connector(86mm motor drive only)

Item	Specification	Maker
Terminal Block	AK950-4	PTR
Housing	3191-4RI	MOLEX
Terminal	138IT	MOLEX

CN4 : Power Connector(86mm motor drive only)

Item	Specification	Maker
Terminal Block	AK950-2	PTR

System Configuration

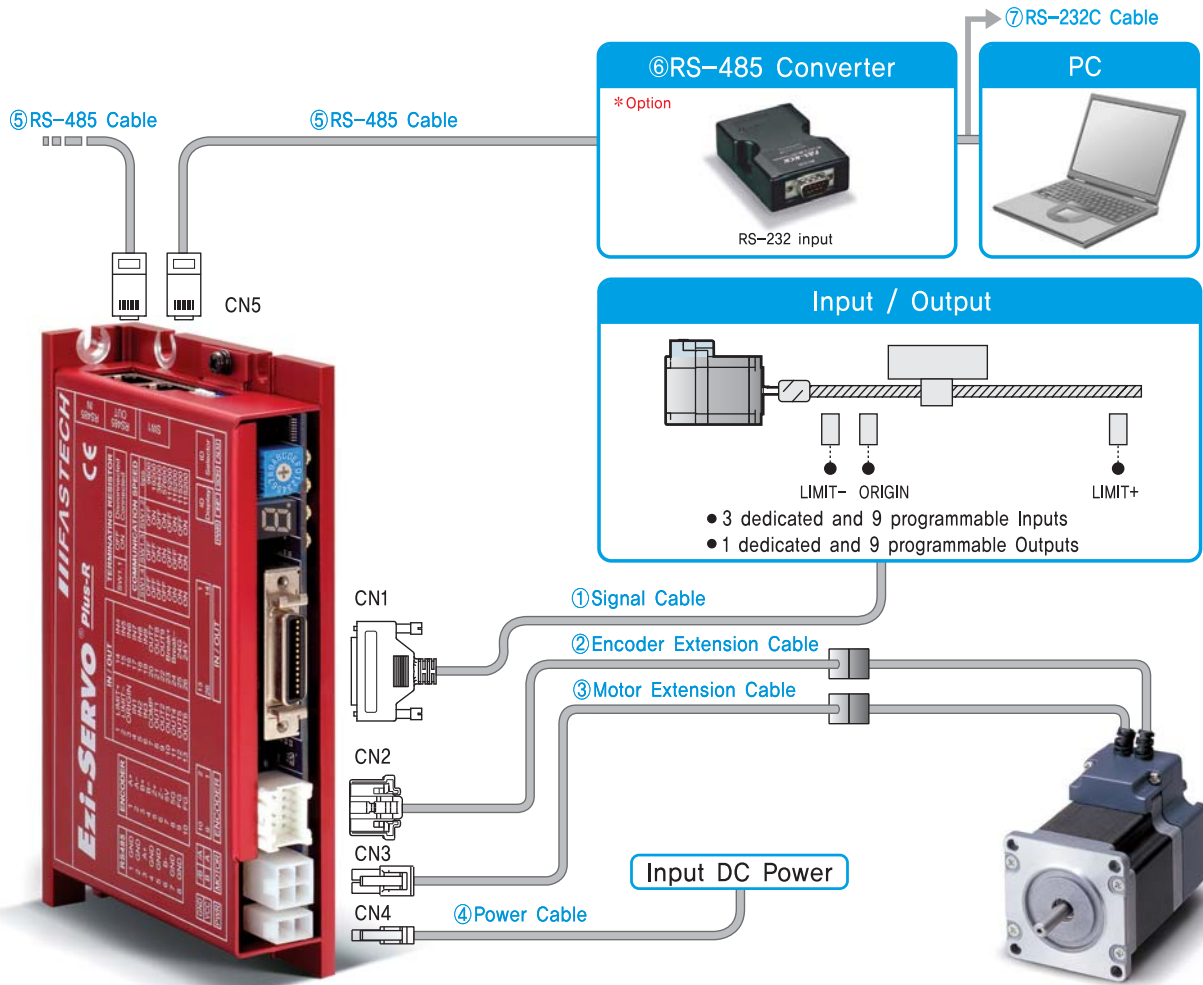

FASTECH Ezi-SERVO Plus-R

Type	Signal Cable	Encoder Cable	Motor Cable	Power Cable	RS-485 Cable
Standard Length	—	30cm	30cm	—	—
Max. Length	20m	20m	20m	2m	30m

1. Cable Option

①Signal Cable

Available to connect between Control System and Ezi-SERVO Plus-R.

Item	Length[m]	Remark
CSVR-S-□□□F	□□□	Normal Cable
CSVR-S-□□□M	□□□	Robot Cable

□ is for Cable Length. The unit is 1m and Max. 20m length.

②Encoder Extension Cable

Available to extended connection between Encoder and Ezi-SERVO Plus-R.

Item	Length[m]	Remark
CSVO-E-□□□F	□□□	Normal Cable
CSVO-E-□□□M	□□□	Robot Cable

□ is for Cable Length. The unit is 1m and Max. 20m length.

③ Motor Extension Cable

Available to extended connection between motor and Ezi-SERVO Plus-R.

Item	Length[m]	Remark
CSVO-M-□□□F	□□□	Normal Cable
CSVO-M-□□□M	□□□	Robot Cable

□ is for Cable Length. The unit is 1m and Max. 20m length.

④ Power Cable

Available to connect between Power and Ezi-SERVO Plus-R.

Item	Length[m]	Remark
CSVO-P-□□□F	□□□	Normal Cable
CSVO-P-□□□M	□□□	Robot Cable

□ is for Cable Length. The unit is 1m and Max. 2m length.

⑤ RS-485 Cable

Item	Length[m]	Remark
CGNR-R-0R6F	0.5	Normal Cable
CGNR-R-001F	1	
CGNR-R-1R5F	1.5	
CGNR-R-002F	2	
CGNR-R-003F	3	
CGNR-R-005F	5	

2. Option

⑥ FAS-RCR(RS-232C to RS-485 Converter)

Item	Specification
Comm. Speed	Max, 115,2Kbps
Comm. Distance	RS-232C : Max, 15m RS-485 : Max, 1,2km
Connector Type	RS-232C : DB9 Female RS-485 : RJ-45
Dimension	50X75X23mm
Weight	38g
Power	Powered from PC (Usable for external DC5~24V)

⑦ RS-232C Cable

Item	Length[m]	Remark
CGNR-C-002F	2	Normal Cable
CGNR-C-003F	3	
CGNR-C-005F	5	

⑧ TB-Plus(Interface Board)

Available to connect more conveniently between Input/Output signal and Ezi-SERVO Plus-R.

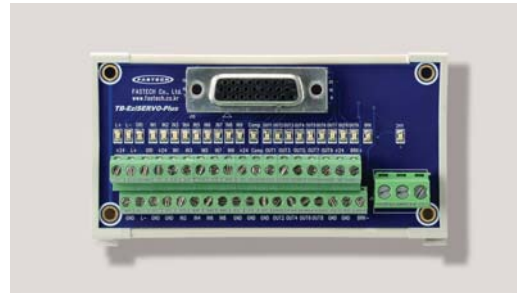

Interface Cable

Available to Connect between TB-Plus Interface Board and Ezi-SERVO Plus-R.

Item	Length[m]	Remark
CIFD-S-□□□F	□□□	Normal Cable
CIFD-S-□□□M	□□□	Robot Cable

□ is for Cable Length. The unit is 1m and Max. 20m length.

● System Configuration [Only for 86mm motor drive (EzS-NDR-86 series)]

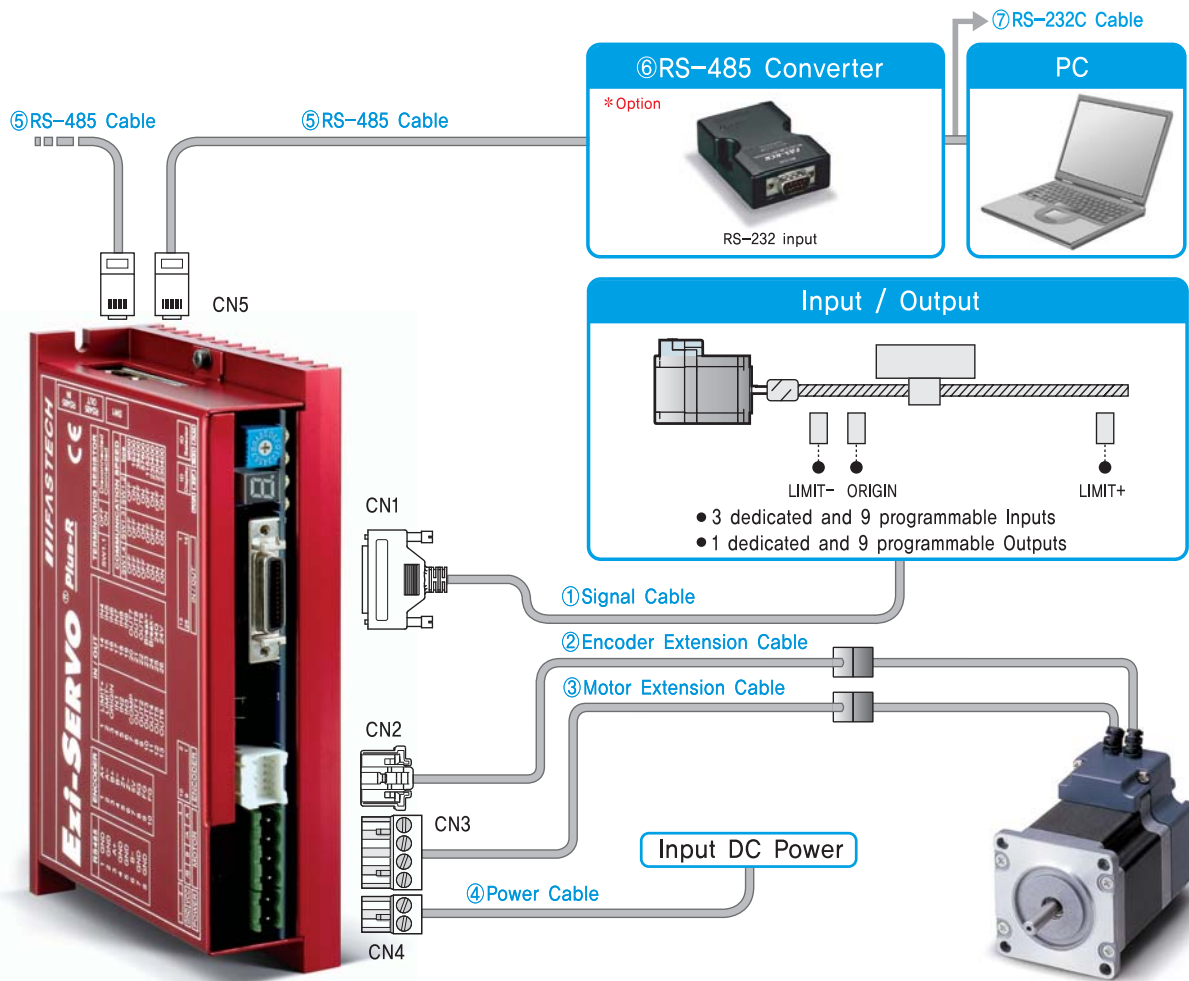

Type	Signal Cable	Encoder Cable	Motor Cable	Power Cable	RS-485 Cable
Standard Length	—	30cm	30cm	—	—
Max. Length	20m	20m	20m	2m	30m

1. Cable Option

① Signal Cable

Available to connect between Control System and Ezi-SERVO Plus-R.

Item	Length[m]	Remark
CSVR-S-□□□F	□□□	Normal Cable
CSVR-S-□□□M	□□□	Robot Cable

□ is for Cable Length, The unit is 1m and Max. 20m length.

② Encoder Extension Cable

Available to extended connection between Encoder and Ezi-SERVO Plus-R.

Item	Length[m]	Remark
CSVO-E-□□□F	□□□	Normal Cable
CSVO-E-□□□M	□□□	Robot Cable

□ is for Cable Length, The unit is 1m and Max. 20m length.

③ Motor Extension Cable

Available to Extended connection between motor and Ezi-SERVO Plus-R,

Item	Length[m]	Remark
CSVP-M-□□□F	□□□	Normal Cable
CSVP-M-□□□M	□□□	Robot Cable

□ is for Cable Length, The unit is 1m and Max, 20m length,

④ Power Cable

Available to connect between Power and Ezi-SERVO Plus-R,

Item	Length[m]	Remark
CSVP-P-□□□F	□□□	Normal Cable
CSVP-P-□□□M	□□□	Robot Cable

□ is for Cable Length, The unit is 1m and Max, 2m length,

⑤ RS-485 Cable

Item	Length[m]	Remark
CGNR-R-0R6F	0,6	Normal Cable
CGNR-R-001F	1	
CGNR-R-1R5F	1,5	
CGNR-R-002F	2	
CGNR-R-003F	3	
CGNR-R-005F	5	

2. Option

⑥ FAS-RCR(RS-232C to RS-485 Converter)

Item	Specification
Comm. Speed	Max, 115,2Kbps
Comm. Distance	RS-232C : Max, 15m RS-485 : Max, 1,2km
Connector Type	RS-232C : DB9 Female RS-485 : RJ-45
Dimension	50X75X23mm
Weight	38g
Power	Powered from PC (Usable for external DC5~24V)

⑦ RS-232C Cable

Item	Length[m]	Remark
CGNR-C-002F	2	Normal Cable
CGNR-C-003F	3	
CGNR-C-005F	5	

⑧ TB-Plus(Interface Board)

Available to connect more conveniently between Input/Output signal and Ezi-SERVO Plus-R,

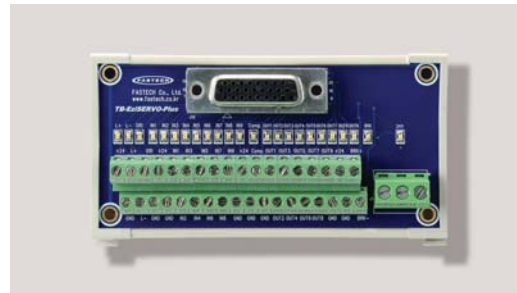

Interface Cable

Available to Connect between TB-Plus Interface Board and Ezi-SERVO Plus-R,

Item	Length[m]	Remark
CIFD-S-□□□F	□□□	Normal Cable
CIFD-S-□□□M	□□□	Robot Cable

□ is for Cable Length, The unit is 1m and Max, 20m length,

External Wiring Diagram

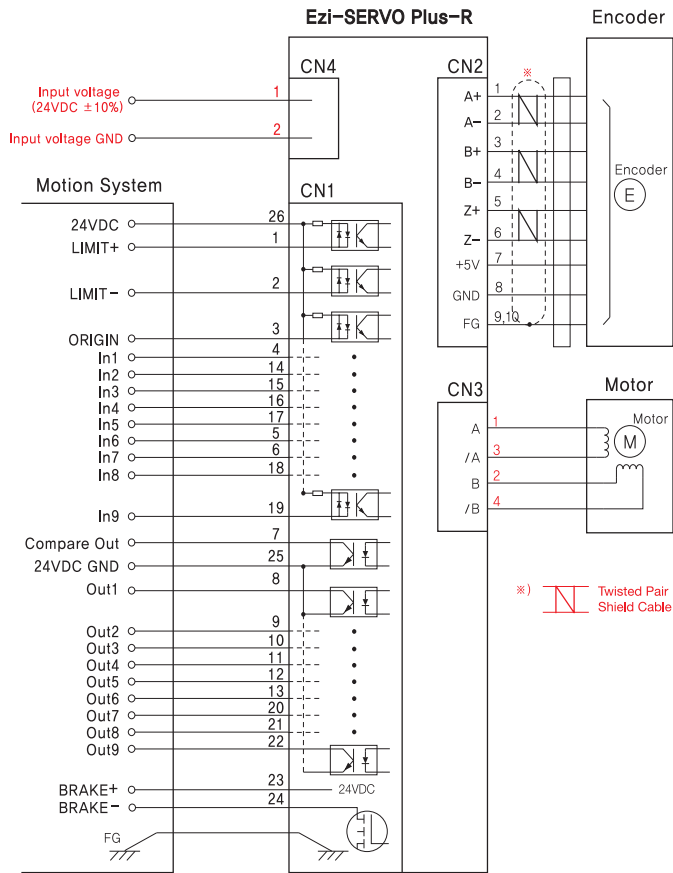

※ CAUTION ※

Please refer to the Manual when connects motor extension cable. Careful connection will be required to protect any damages.

External Wiring Diagram [Only for 86mm motor drive (EzS-NDR-86 series)]

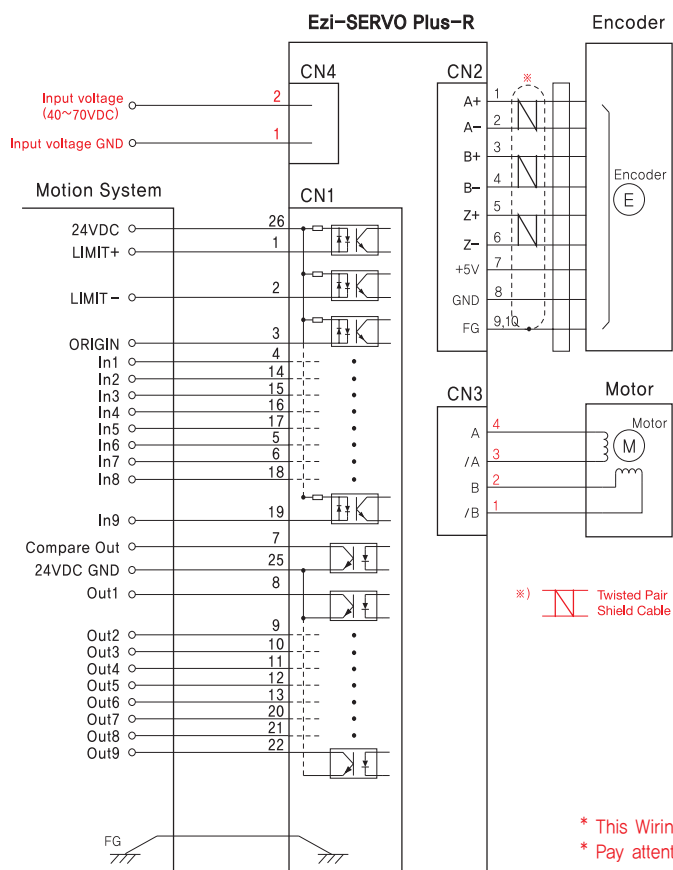

※ CAUTION ※

Please refer to the Manual when connects motor extension cable. Careful connection will be required to protect any damages.

* This Wiring Diagram is only for 86mm motor drive(EzS-NDR-86 series).
* Pay attention to red color that describe the difference.

GUI(Graphic User Interface) Screenshot

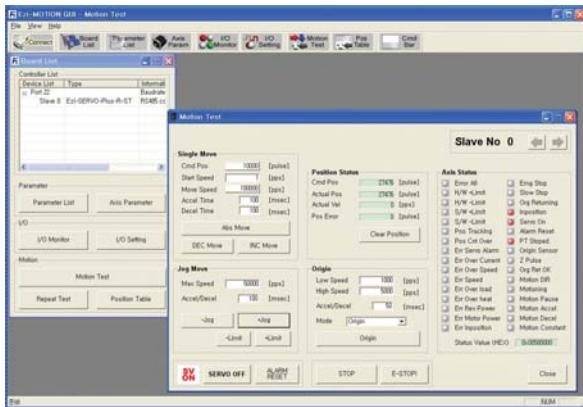

◆ Controller Lists and Motion Test

This screen display the controller list that connected to system. You can make a single move, jog and origin command and also the motor status is displayed.

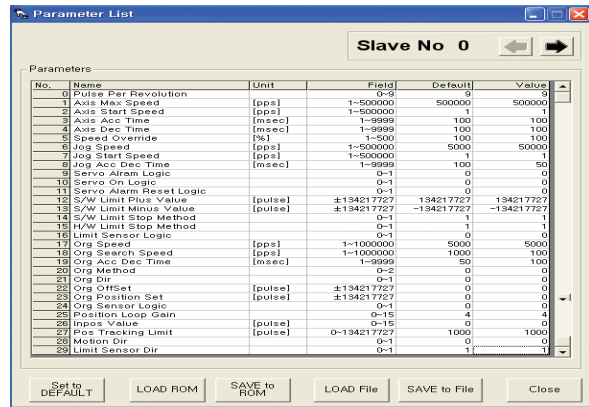

◆ Parameter List

All of the parameters are displayed and modified on this screen.

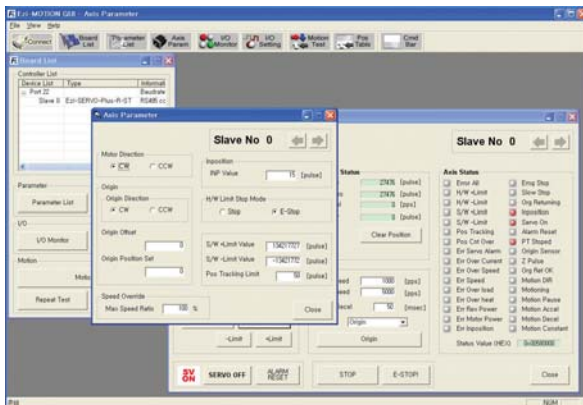

◆ Axis Parameter Setup

You can select various parameters that frequently used. (ex : sensor input logic)

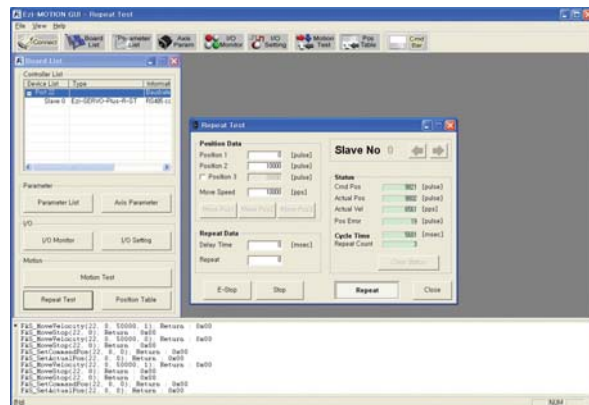

◆ Motion Repeat and Monitor Status

Target position, speed, delay time and repeat count are selected for repeat motion test. Motion library(DLL) is also displayed on screen.

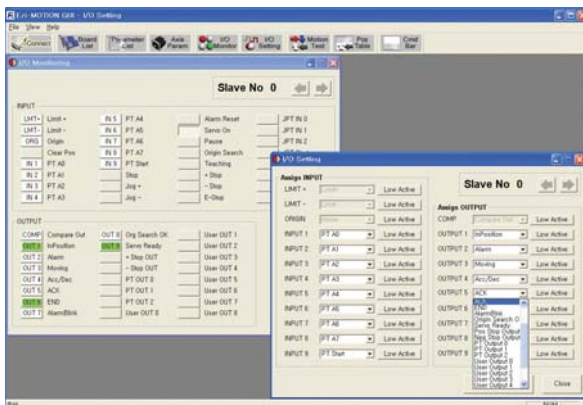

◆ I/O Monitoring and Setting

You can select various digital input and output signals of controller.

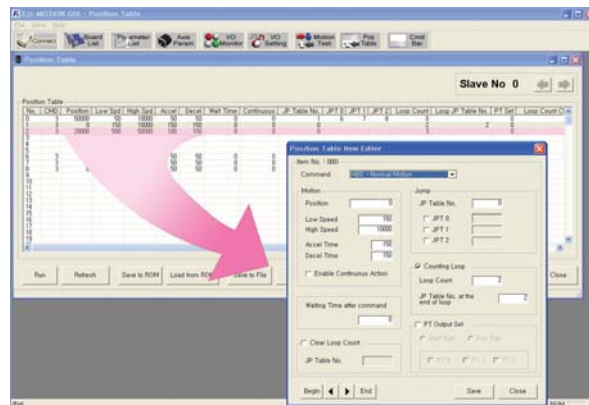

◆ Position Table

You can edit the position table and execute it. The position table data can be saved and loaded from Flash ROM and Windows file.



FASTECH Ezi-SERVO Plus-R



FASTECH Co., Ltd.

Rm #1202, Bucheon Technopark 401 Dong, Yakdea-dong,
Wonmi-Gu, Bucheon-si, Gyeonggi-do, Rep. Of Korea (Zip)420-734
TEL : 82-32-234-6300,6301 FAX : 82-32-234-6302
E-mail : daniel@fastech.co.kr website: www.fastech.co.kr

FASTECH AMERICA LLC

811 E Plano Parkway, Suite 110A, Plano, TX 75074 USA
Toll Free: 877-905-4428 972-218-0210
Email: support@fastechamerica.com
website: www.fastechamerica.com